

TECHNICAL DESCRIPTION

FEATURES

- 960 - 1220 MHz
- LOW LOSS
- HIGH ISOLATION
- EXCELLENT PHASE/AMPLITUDE BALANCE
- SURFACE MOUNT
- TAPE & REEL AVAILABLE

APPLICATIONS

- JTRS



The Multi-Mix® QHDZ series provides a 3 dB 90° coupling with low insertion loss, low VSWR, and high isolation. Accurate phase and amplitude balance make this series ideal for use in IQ networks, power amplifiers, radio transceivers, receiver multicouplers and RF signal distribution and processing equipment.

QHDZ quad hybrids are fusion bonded multilayer stripline devices. The fusion bonding process yields a homogeneous monolithic dielectric structure with reliability, ruggedness, and electrical performance that is superior to conventional adhesive bonding techniques.

GENERAL SPECIFICATIONS

FREQUENCY RANGE MHz		INSERTION LOSS (dB MAX)	AMPLITUDE BALANCE (dB MAX)	PHASE BALANCE
960 - 1220		0.15	± 0.3	90 ± 2°
ISOLATION (dB MIN)	VSWR (MAX, ALL PORTS)	INPUT POWER (CW @ 1.2:1 LOAD VSWR)	RF INTERFACE	OPERATING TEMPERATURE
23	1.15:1	200 WATTS	Surface Mount	-55° - +95° C

PACKAGE OUTLINE / TAPE & REEL ORIENTATION

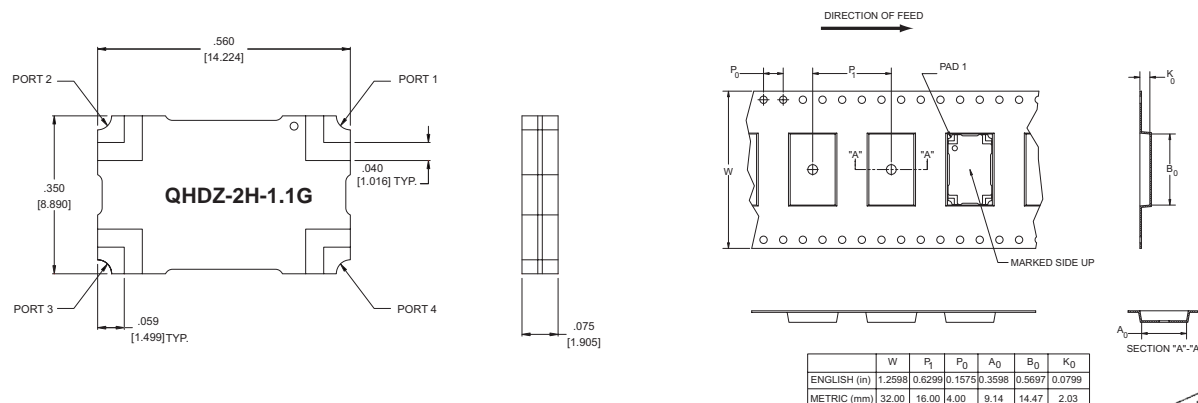

THE MULTI-MIX MICROTECHNOLOGY® GROUP IS ISO 9001:2000 REGISTERED



U.S. Patent 6,099,677 and other Patents Pending.

TYPICAL PERFORMANCE

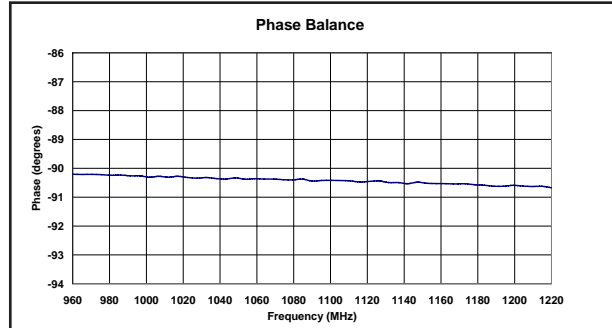
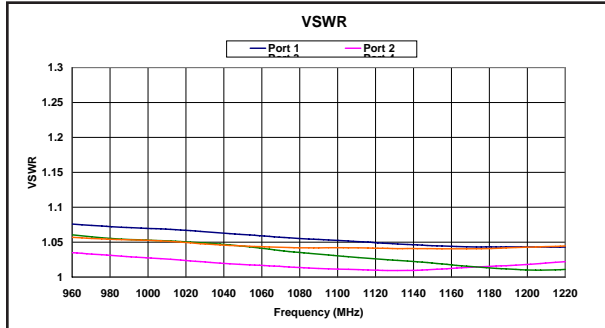
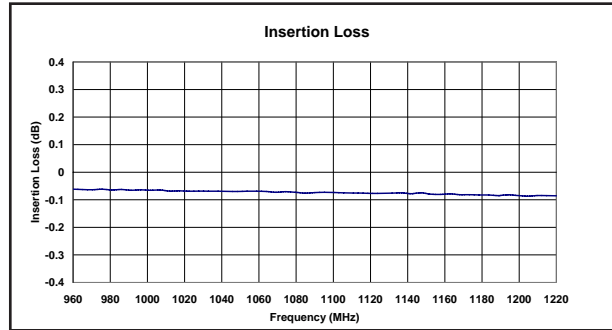
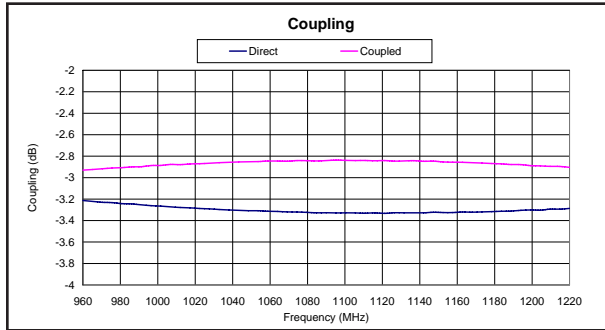

MOUNTING CONFIGURATION

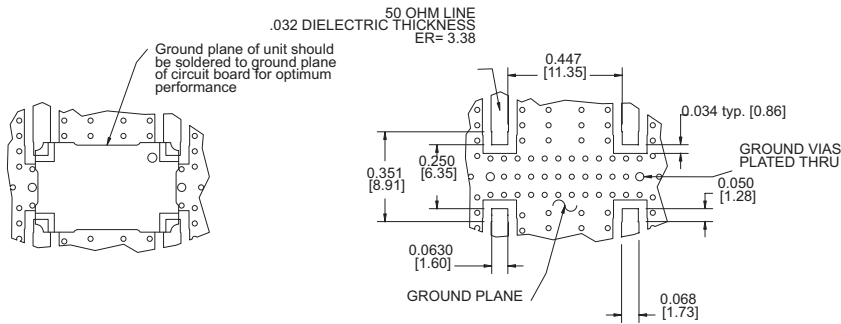

TRUTH TABLE

	1	2	3	4
1	Input	Iso	-90°	0°
2	Iso	Input	0°	-90°
3	-90°	0°	Input	Iso
4	0°	-90°	Iso	Input