

Darlington

# 2SB1559

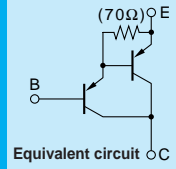

Silicon PNP Epitaxial Planar Transistor (Complement to type 2SD2389)

Application : Audio, Series Regulator and General Purpose

**Absolute maximum ratings** (Ta=25°C)

Symbol	2SB1559	Unit
V <sub>CB0</sub>	-160	V
V <sub>CE0</sub>	-150	V
V <sub>EB0</sub>	-5	V
I <sub>c</sub>	-8	A
I <sub>B</sub>	-1	A
P <sub>c</sub>	80(T <sub>c</sub> =25°C)	W
T <sub>J</sub>	150	°C
T <sub>stg</sub>	-55 to +150	°C

**Electrical Characteristics** (Ta=25°C)

Symbol	Conditions	2SB1559	Unit
I <sub>CB0</sub>	V <sub>CB</sub> =-160V	-100max	μA
I <sub>EB0</sub>	V <sub>EB</sub> =-5V	-100max	μA
V <sub>(BR)CEO</sub>	I <sub>c</sub> =-30mA	-150min	V
h <sub>FE</sub>	V <sub>CE</sub> =-4V, I <sub>c</sub> =-6A	5000min*	
V <sub>CE(sat)</sub>	I <sub>c</sub> =-6A, I <sub>B</sub> =-6mA	-2.5max	V
V <sub>BE(sat)</sub>	I <sub>c</sub> =-6A, I <sub>B</sub> =-6mA	-3.0max	V
f <sub>r</sub>	V <sub>CE</sub> =-12V, I <sub>E</sub> =1A	65typ	MHz
COB	V <sub>CB</sub> =-10V, f=1MHz	160typ	pF

**External Dimensions MT-100(TO3P)**

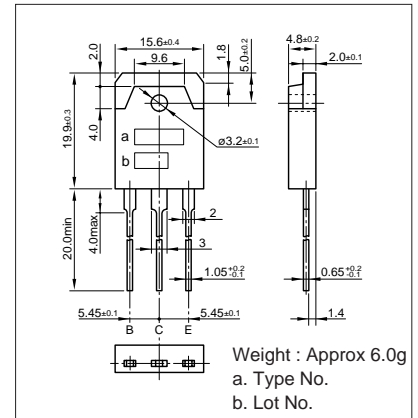

**Typical Switching Characteristics (Common Emitter)**

V <sub>CC</sub> (V)	R <sub>L</sub> (Ω)	I <sub>c</sub> (A)	V <sub>BB1</sub> (V)	V <sub>BB2</sub> (V)	I <sub>B1</sub> (mA)	I <sub>B2</sub> (mA)	t <sub>on</sub> (μs)	t <sub>stg</sub> (μs)	t <sub>f</sub> (μs)
-60	10	-6	-10	5	-6	6	0.7typ	3.6typ	0.9typ

I<sub>c</sub>-V<sub>CE</sub> Characteristics (Typical)

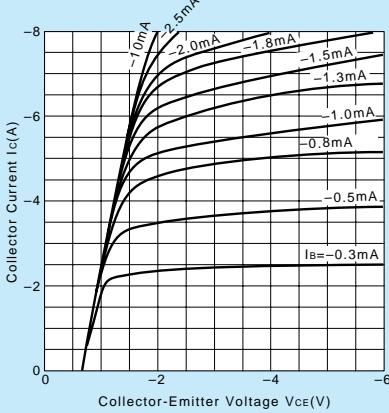

V<sub>CE(sat)</sub>-I<sub>B</sub> Characteristics (Typical)

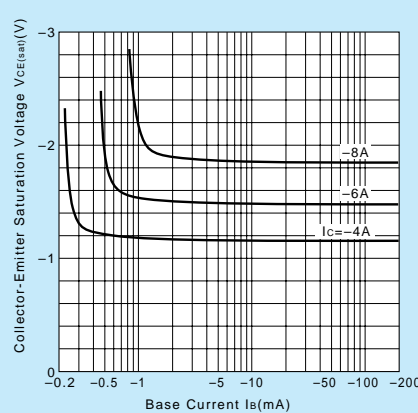

I<sub>c</sub>-V<sub>BE</sub> Temperature Characteristics (Typical)

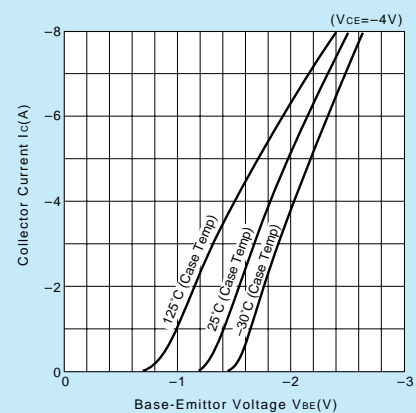

h<sub>FE</sub>-I<sub>c</sub> Characteristics (Typical)

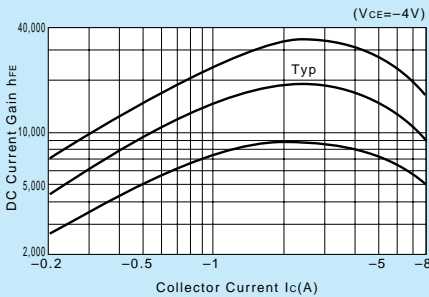

h<sub>FE</sub>-I<sub>c</sub> Temperature Characteristics (Typical)

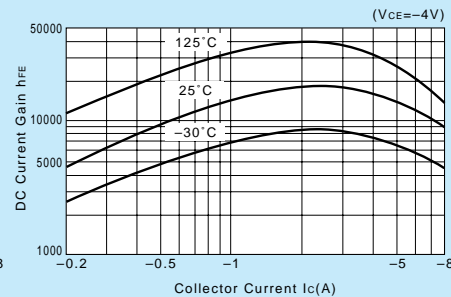

θ<sub>j-a</sub>-t Characteristics

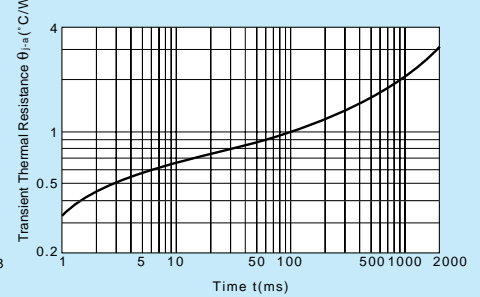

f<sub>r</sub>-I<sub>E</sub> Characteristics (Typical)

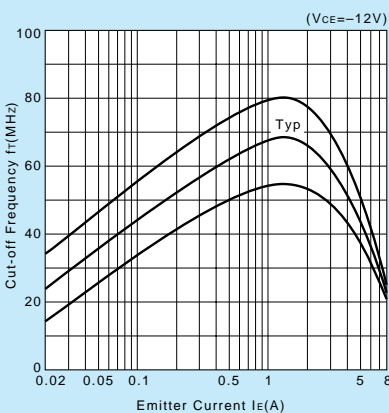

Safe Operating Area (Single Pulse)

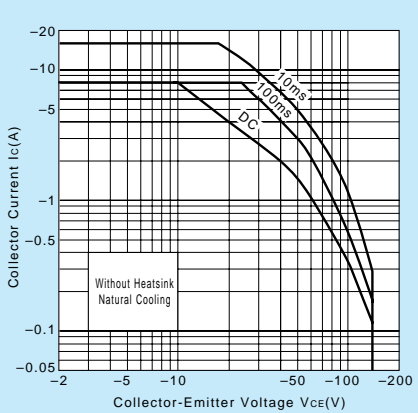

P<sub>c</sub>-T<sub>a</sub> Derating

