

450-3256 Solder mount, through hole socket, for .080 (2,03) diameter pins

Recommended mounting hole .144 (3,66) ±.001 (0,03), # 43 drill

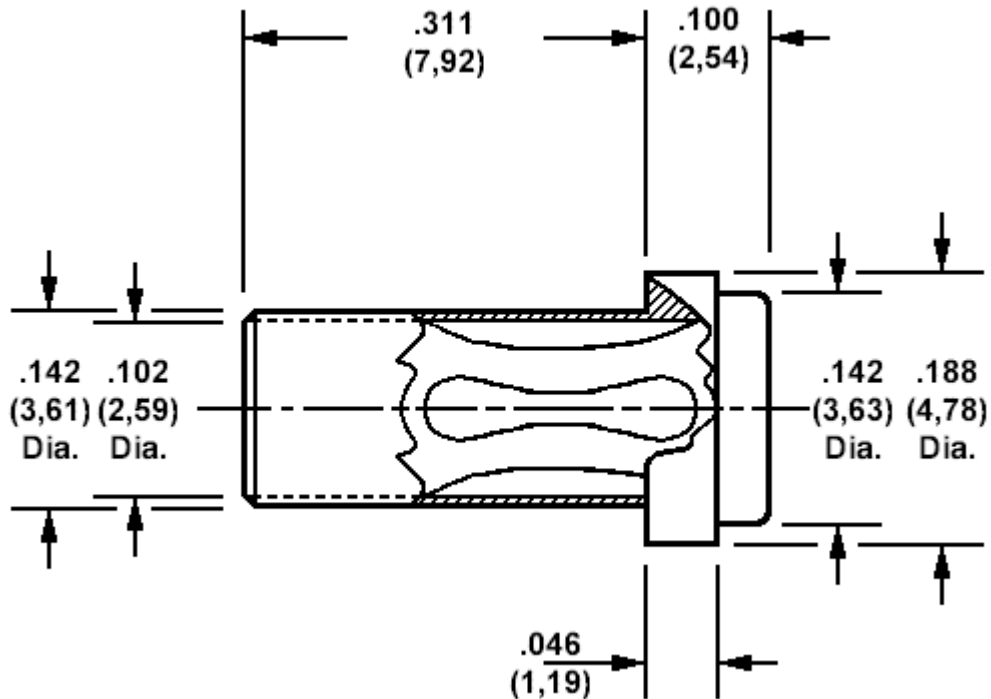

Through Hole .102 (2,59)

How to order code
450-3256-01-XX-00
 Basic Part No XX = Finish

MATERIALS				
Component	Material	Finish(-03)	Finish(-04)	Finish(-06)
Body	Brass	Gold over Nickel	Tin	Tin
Spring	Beryllium copper	Gold over Nickel	Tin	Gold over Nickel