



SAW TECHNOLOGY CO., LTD.

No. 3, Industrial 2nd Rd., Ping-Chen Industrial District,
Taoyuan, 324, Taiwan, R.O.C.

TEL: 886-3-4690038 FAX: 886-3-4697532

E-mail: ttsales@mail.taisaw.com Web: www.taisaw.com

Product Specifications Approval Sheet

Product Description: SAW Filter 153.6MHz SMD 13.3×6.5mm

TST Part No.: TB0850A

Customer Part No.: _____

Customer signature required
Company: _____
Division: _____
Approved by : _____
Date: _____

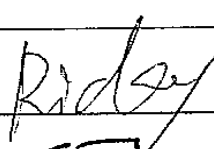
Checked by: _____ Ricky Lee 

Approved by: _____ Francis Chen 

Date: _____ 2010/03/04

1. Customer signed back is required before TST can proceed with sample build and receive orders.
2. Orders received without customer signed back will be regarded as agreement on the specifications.
3. Any specifications changes must be approved upon by both parties and a new revision of specifications shall be released to reflect the changes.



TAI-SAW TECHNOLOGY CO., LTD.

No. 3, Industrial 2nd Rd., Ping-Chen Industrial District,
Taoyuan, 324, Taiwan, R.O.C.

TEL: 886-3-4690038 FAX: 886-3-4697532

E-mail: tstsales@mail.taisaw.com Web: www.taisaw.com

IF SAW Filter 153.6MHz(BW=20MHz) SMD 13.3X6.5mm

MODEL NO.: TB0850A

REV.1.0

A. MAXIMUM RATING:

1. Operating Temperature: -0 °C ~ +70 °C
2. Storage Temperature: -40 °C ~ +85 °C
3. Input power: 10dBm

RoHS Compliant
Lead free
Lead-free soldering

B. Characteristics :

Ambient Temperature: 25 °C

Characteristics	Value			Note
	Min.	Typ.	Max.	
Center frequency F_c MHz	-	153.6	-	-
Minimum Insertion loss I.L. dB	-	9.5	13.0	-
1dB BW MHz	20	23.18	-	-
Passband Ripple ($F_c \pm 10.0\text{MH}$) dB	-	0.45	1.0	-
Attenuation (Reference to Minimum Insertion loss)				
139.6MHz dB	10	19.5	-	-
168.6MHz dB	10	26	-	-
Temp Coefficient ppm/K	-	-94	-	-
Matching:				
1.The input of the filter will be matched to <u>50 ohm</u>				
2.The output of the filter will be matched to <u>50 ohm</u>				

C. Frequency Characteristics :

1. S21 Response: (span : 80MHz)

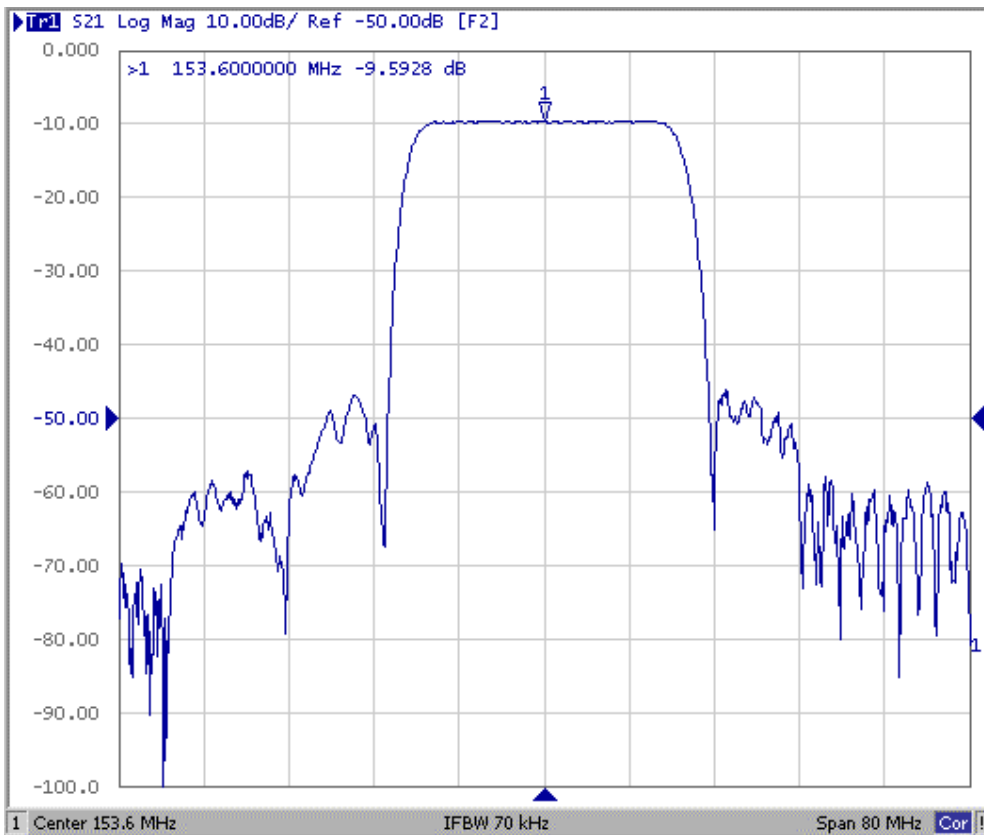

Fig1. Horizontal: 8MHz/Div Vertical: 10dB/Div

2. Group-Delay Ripple: (span : 40MHz)

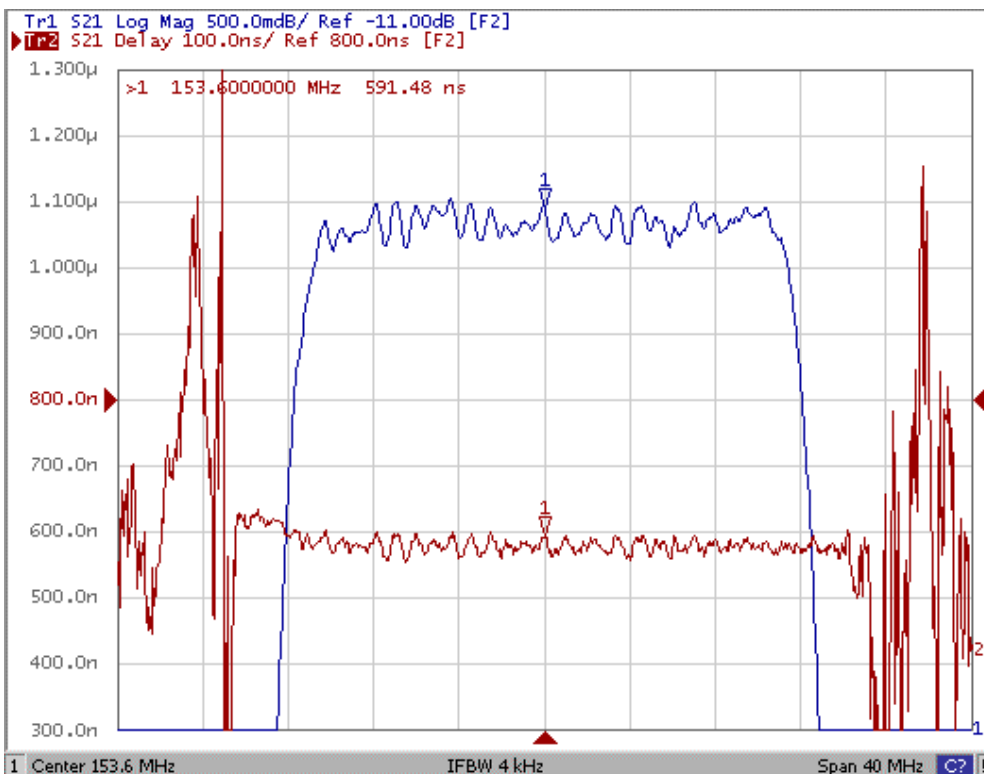
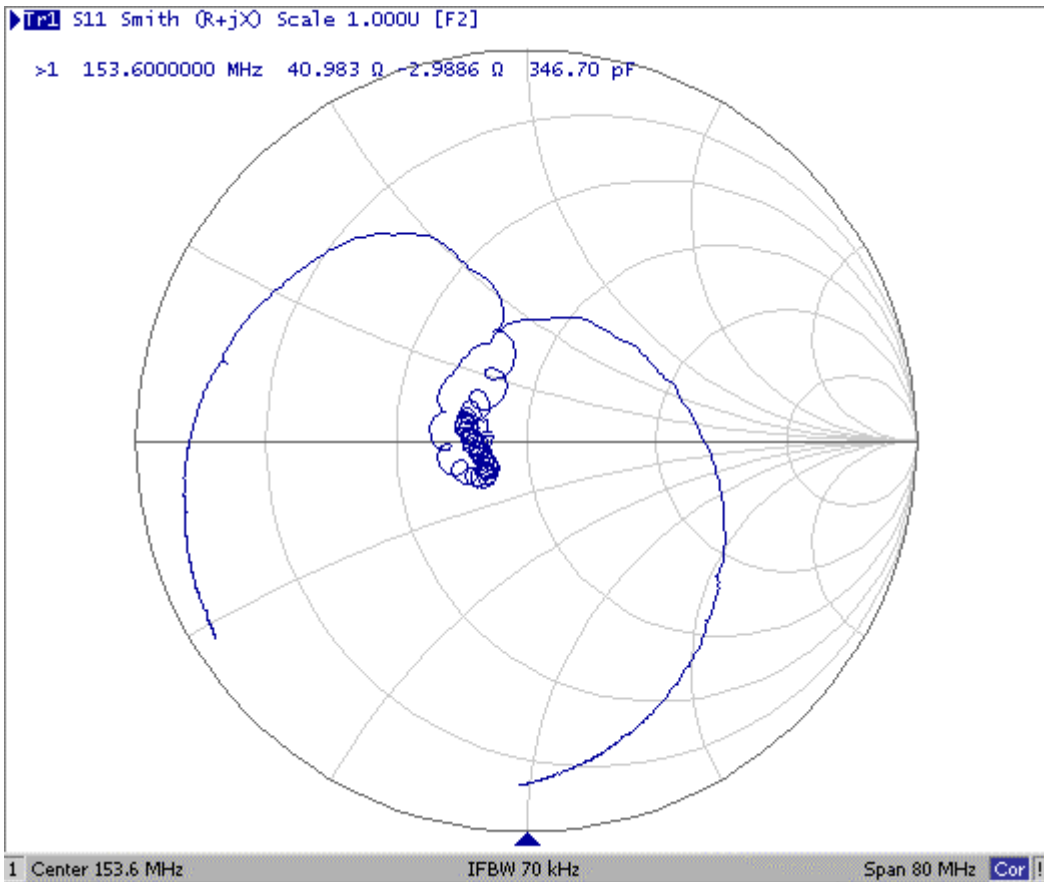
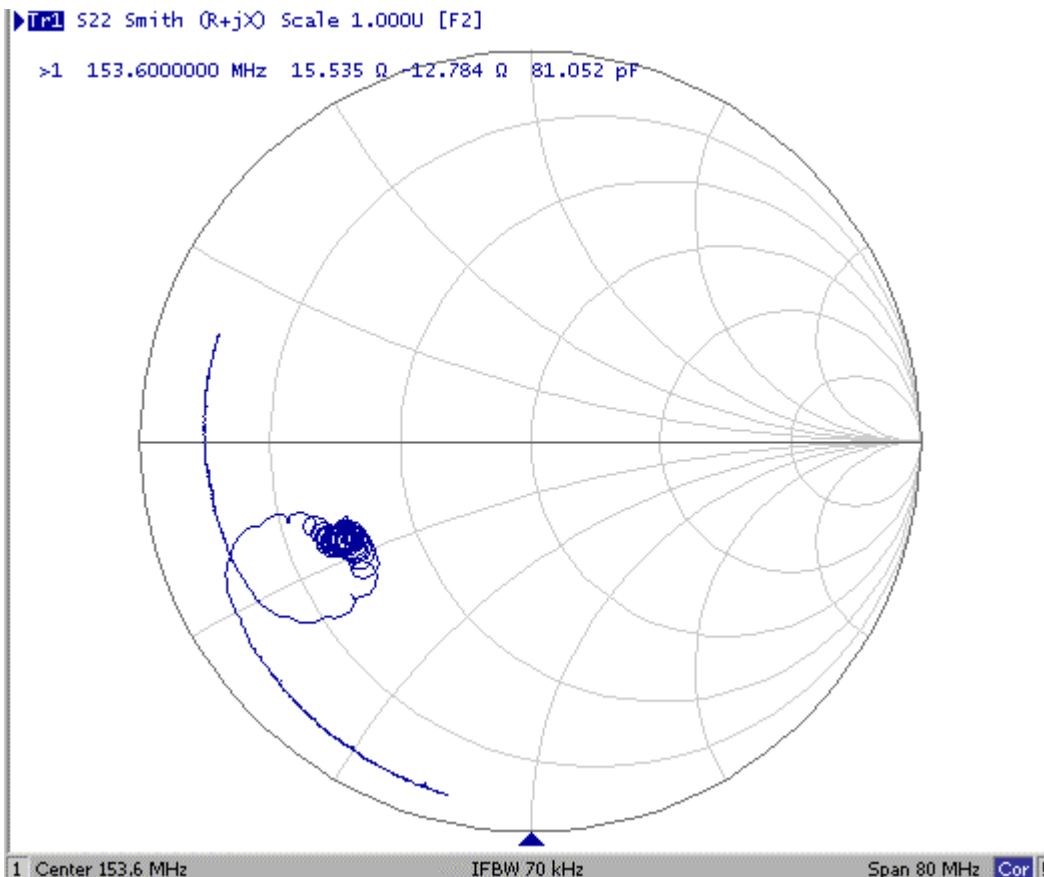

Fig2. Horizontal: 4MHz/Div Vertical: 100nec/Div

3. S11 Smith Chart: (span : 80MHz)



4. S22 Smith Chart (span : 80MHz)



D. Measurement Circuit:

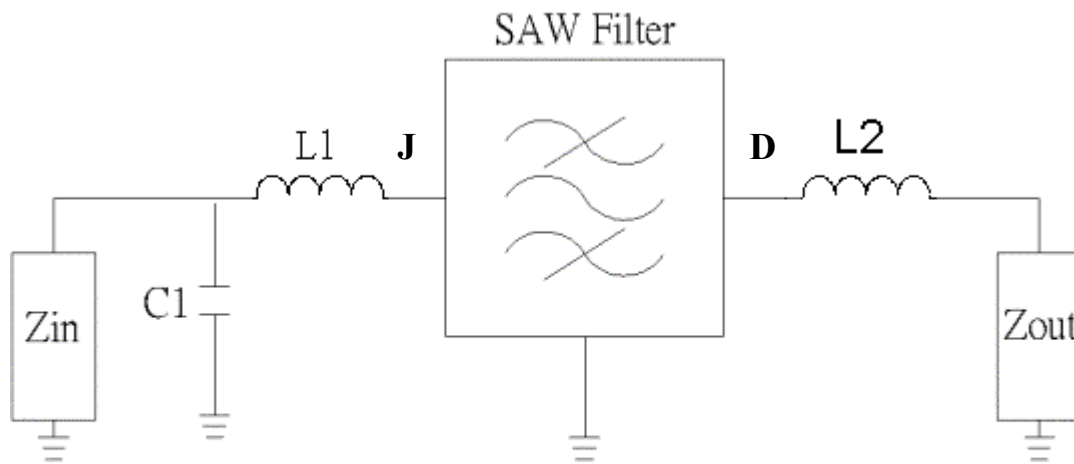

Zin and Zout are $50\ \Omega$.
 $L1=82\text{nH}$, $C1=27\text{pF}$, $L2=33\text{nH}$

E. Outline Drawing:

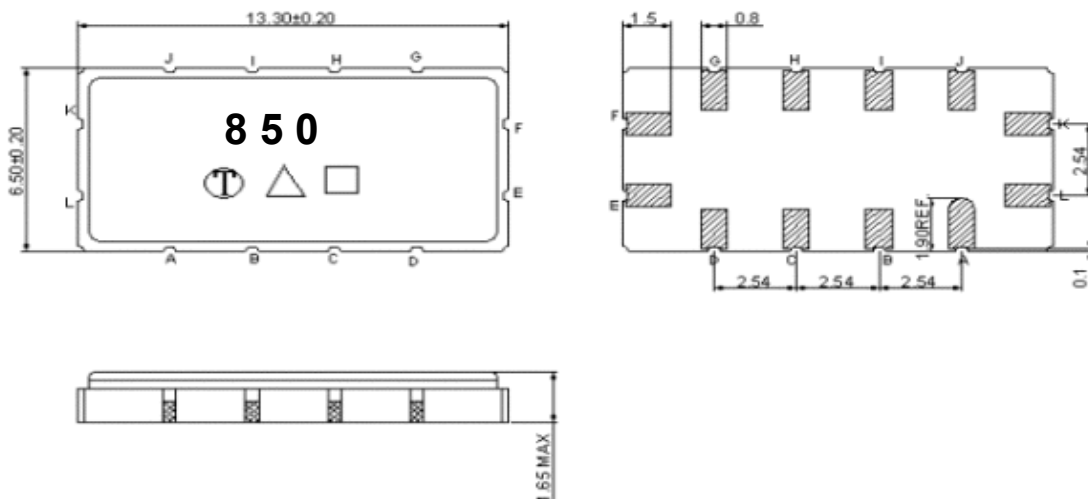

Pin K: RF input

Pin E: RF output

Pin A, B, C, D, G, H, I, L, F, J: To be Ground

□ : Week Code (Follow the table from planner each year)

Unit : mm (week01, 02, 03...52 =>A, B, C...z)

△ : Product / Year Code

Year	2009	2010	2011	2012
Product Code	B	b	<u>B</u>	<u>b</u>

F. PCB Footprint:

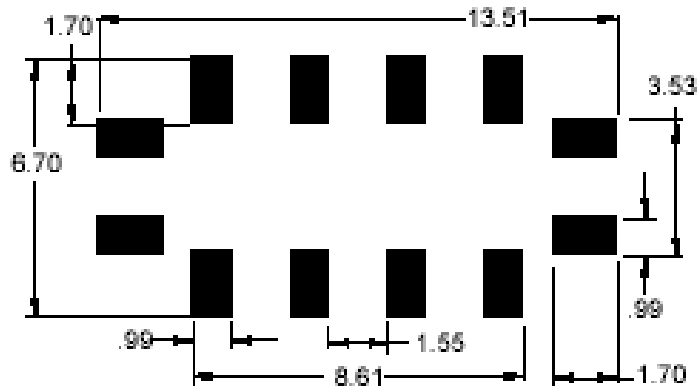

Unit: mm

H. PACKING:

1. REEL DIMENSION

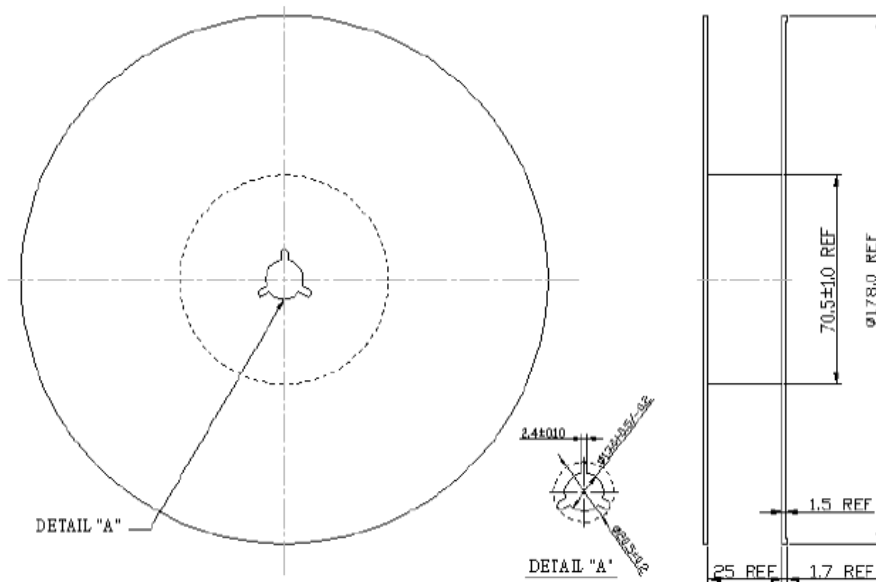

Unit: mm

2. TAPE DIMENSION

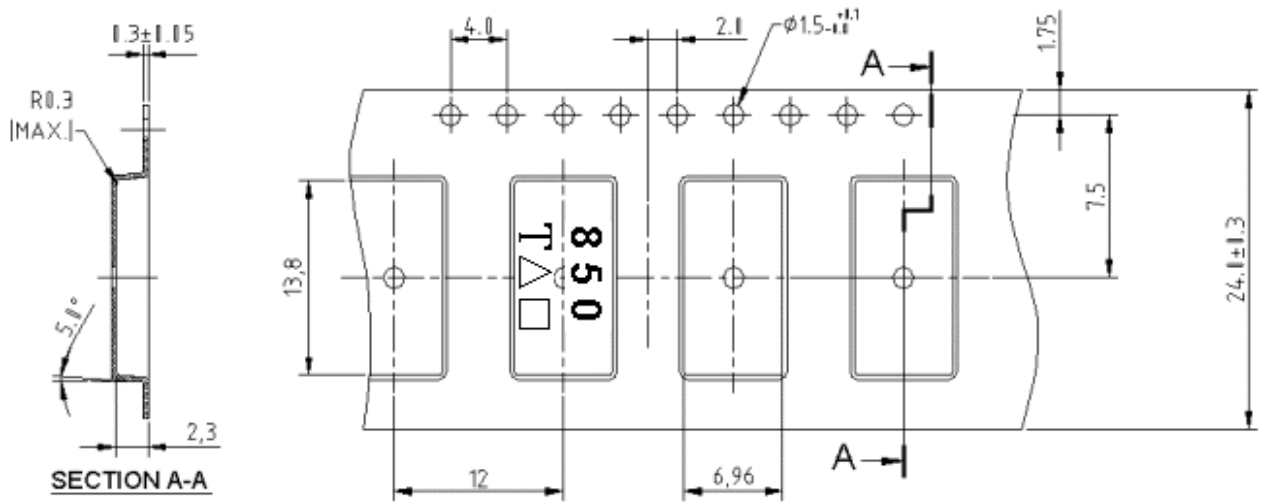

Unit: mm

I. RECOMMENDED REFLOW PROFILE :

