

GENERAL DESCRIPTION

The RM1556/RC1556 are high performance, high gain operational amplifiers. Each amplifier is internally compensated and fabricated on a single silicon chip by the planar epitaxial process.

These amplifiers feature high common-mode and differential voltage range, very low input bias current, optimum performance over a wide range of supply voltage, and freedom from "latch-up." They are ideal for use as voltage followers, comparators, integrators, summing and general purpose amplifiers.

The RM types operate over a temperature range of -55°C to $+125^{\circ}\text{C}$. The RC types operate from 0°C to $+70^{\circ}\text{C}$.

DESIGN FEATURES

- Input Bias Current 15nA Maximum
- Input Offset Current 2nA Maximum
- Input Offset Voltage 4mV Maximum
- At $\pm 15\text{V}$ Current Drain 1.0mA
- Offset Voltage Nulling (10k pot)
- Slew Rate $2.0\text{V}/\mu\text{s}$
- Unity Gain Bandwidth 4MHz
- Gain Variation 3dB from $\pm 3\text{V}$ to $\pm 20\text{V}$
- Open Loop Voltage Gain 106dB

SCHEMATIC DIAGRAM

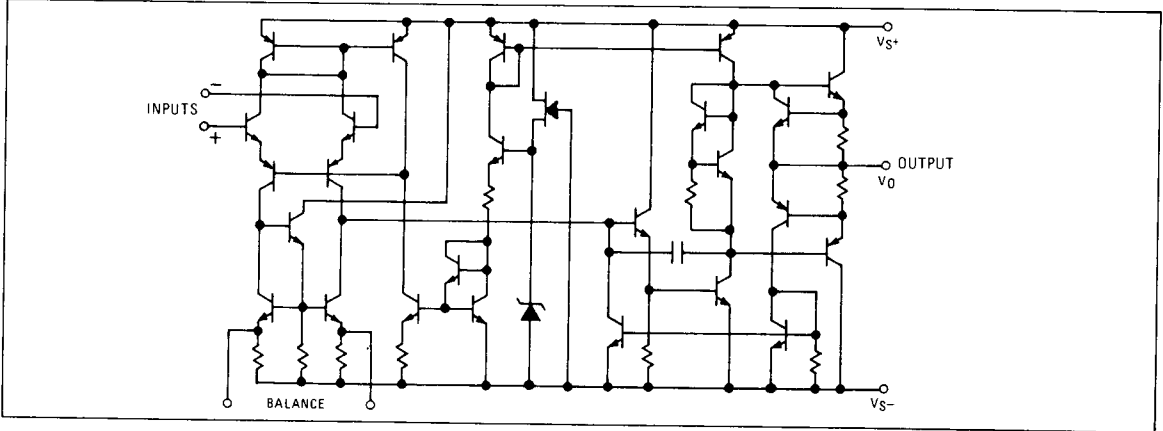

CONNECTION INFORMATION

TE (TO-99)
Metal Can Package
(Top View)

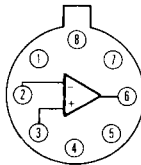

Order Part Nos.:
RM1556T, RC1556T

NB Dual In-line
Plastic Package
(Top View)

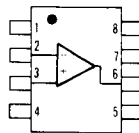

Order Part No.:
RC1556NB

PIN	FUNCTION
1	BAL
2	-INPUT
3	+INPUT
4	V^-
5	BAL
6	OUTPUT
7	V^+
8	NC

ABSOLUTE MAXIMUM RATINGS

Supply Voltage	RM1556: $\pm 22\text{V}$ RC1556: $\pm 18\text{V}$	Operating Temperature Range RM1556 -55°C to $+125^{\circ}\text{C}$ RC1556 0°C to $+70^{\circ}\text{C}$
Internal Power Dissipation (Note 1)	500mW	Lead Temperature (Soldering, 60s) 300°C
Differential Input Voltage	$\pm 30\text{V}$	Output Short-Circuit Duration (Note 3) Indefinite
Input Voltage (Note 2)	$\pm 15\text{V}$	
Storage Temperature Range	-65°C to $+150^{\circ}\text{C}$	

RM1556 AND RC1556 ELECTRICAL CHARACTERISTICS

(RM1556: $-55^{\circ}\text{C} \leq T_A \leq 125^{\circ}\text{C}$; RC1556: $0^{\circ}\text{C} \leq T_A \leq 70^{\circ}\text{C}$; $V_S = \pm 15\text{V}$ unless otherwise specified)

PARAMETER	CONDITIONS	RM1556			RC1556			UNITS
		MIN	TYP	MAX	MIN	TYP	MAX	
Input Offset Voltage	$T_A = 25^{\circ}\text{C}$, $R_S \leq 50\text{k}\Omega$		2.0	4.0		5.0	10	mV
Input Offset Current	$T_A = 25^{\circ}\text{C}$		1.0	2.0		5.0	10	nA
Input Bias Current	$T_A = 25^{\circ}\text{C}$		8.0	15		15	30	nA
Input Resistance	$T_A = 25^{\circ}\text{C}$		5.0			3.0		$\text{M}\Omega$
Supply Current	$T_A = 25^{\circ}\text{C}$		1.0	1.5		1.3	3.0	mA
Large Signal Voltage Gain	$T_A = 25^{\circ}\text{C}$ $V_{\text{OUT}} = \pm 10\text{V}$, $R_L > 2\text{k}\Omega$	100	200		70	100		V/mV
Input Offset Voltage	$R_S \leq 50\text{k}\Omega$			6.0			14	mV
Input Offset Current	$+25^{\circ}\text{C}$ to T_H			3.0			14	nA
	T_L to $+25^{\circ}\text{C}$			5.0			14	
Input Bias Current				30			40	nA
Supply Current				1.9			3.5	mA
Slew Rate (Unity Gain)	$T_A = 25^{\circ}\text{C}$, $R_L \geq 2\text{k}\Omega$		2.0			2.0		V/ μs
Bandwidth (Unity Gain)	$T_A = 25^{\circ}\text{C}$, $R_L \geq 2\text{k}\Omega$		4			4		MHz
Large Signal Voltage Gain	$R_L \geq 2\text{k}\Omega$, $V_{\text{OUT}} = \pm 10\text{V}$	40			40			V/mV
Output Voltage Swing	$T_A = 25^{\circ}\text{C}$, $R_L \geq 2\text{k}\Omega$,	± 12	± 13		± 11	± 12		V
Input Voltage Range		± 12	± 13		± 11	± 12		V
Input Noise Voltage	$R_S = 10\text{k}\Omega$, $f = 1.0\text{kHz}$, $A_V = 100$, $\text{BW} = 1.0\text{Hz}$		25			25		$\text{nV}/\sqrt{\text{Hz}}$
Common-Mode Rejection Ratio	$R_S \leq 50\text{k}\Omega$	80	110		70	110		dB
Supply Voltage Rejection Ratio	$R_L \leq 50\text{k}\Omega$	80	86		74	83		dB

NOTES:

- For operating at elevated temperatures, the device must be derated based on 150°C for RM1556; 100°C for RC1556 maximum junction temperature and a thermal resistance of $150^{\circ}\text{C}/\text{W}$ junction to ambient or $45^{\circ}\text{C}/\text{W}$ junction to case.
- For supply voltages less than $\pm 15\text{V}$, the absolute maximum input voltage is equal to the supply voltage.
- Short-circuit to ground rating applies to $+125^{\circ}\text{C}$ case temperature or $+75^{\circ}\text{C}$ ambient temperature for RM1556.

TYPICAL ELECTRICAL DATA

Supply Current

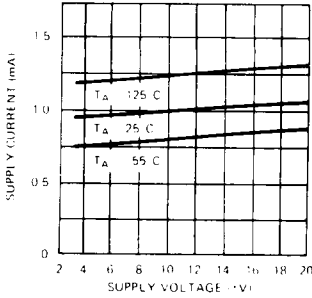

Input Voltage Range

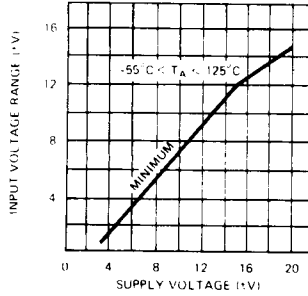

Output Swing

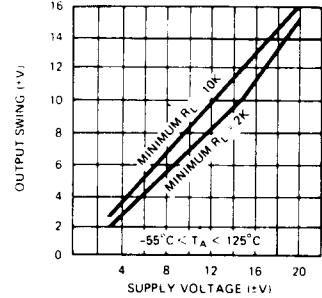

Open Loop Frequency Response

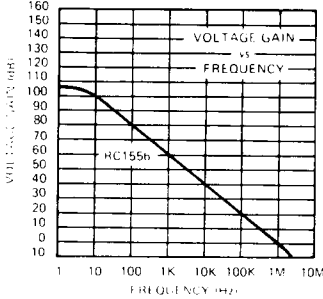

Maximum Power Dissipation

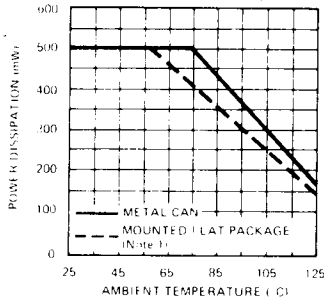

Current Limiting

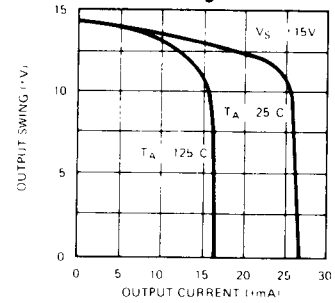

Large Signal Frequency Response

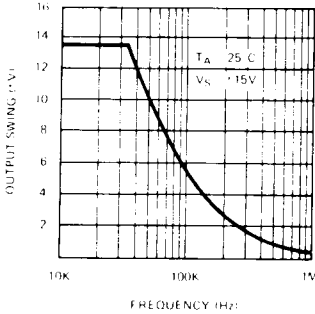

Voltage Follower Large Pulse Response

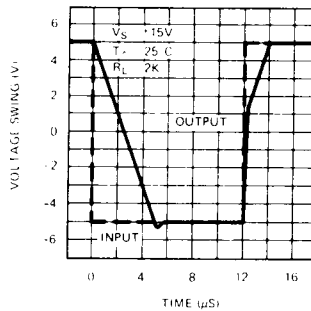

Voltage Follower Small Pulse Response

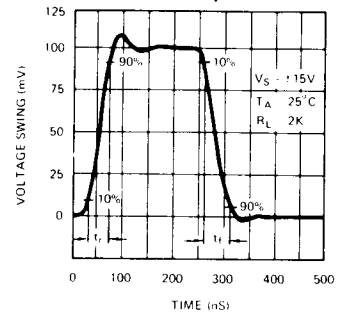

Noise Voltage

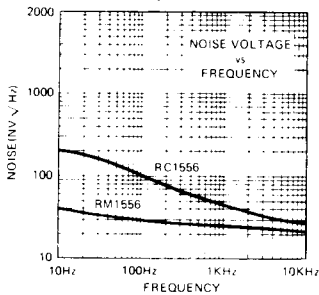

Input Bias Current

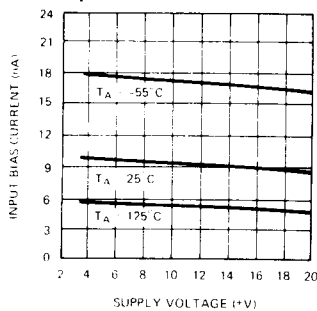

Voltage Gain

