

GaAs Plastic Infrared Emitting Diodes Types OP165A, OP165B, OP165C, OP165D

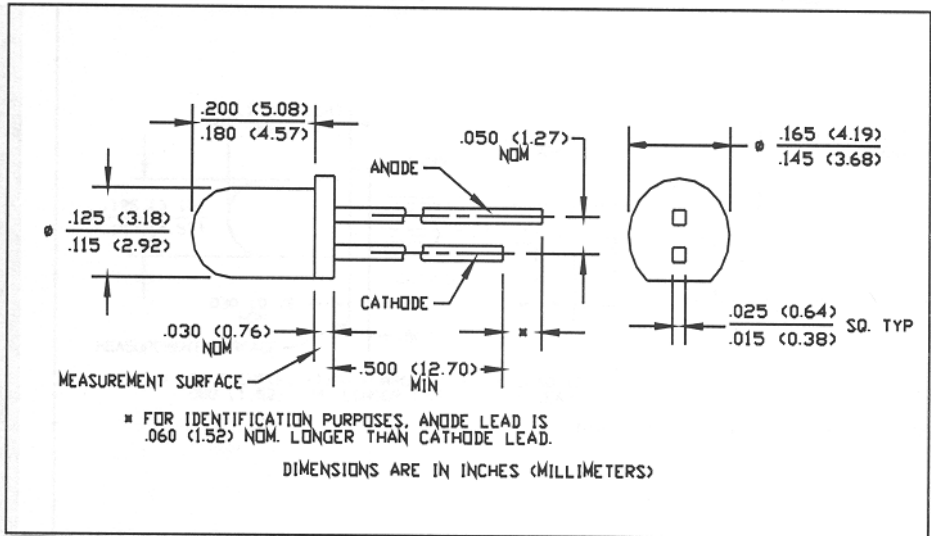
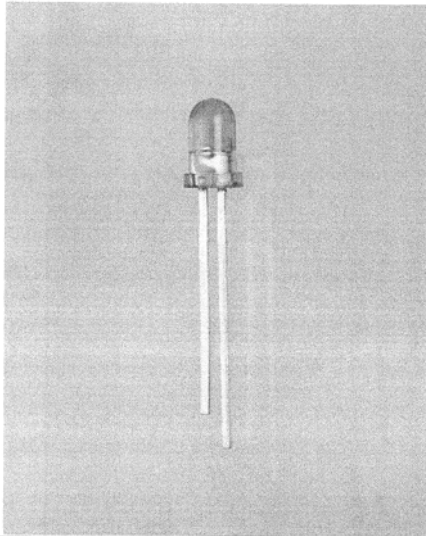

Features

- Narrow irradiance pattern
- Mechanically and spectrally matched to the OP505 and OP535 series devices
- Variety of power ranges
- Small package size for space limited applications
- T-1 package style

Description

The OP165 series devices are 935 nm gallium arsenide infrared emitting diodes molded in IR transmissive amber tinted plastic packages. The narrow irradiance pattern provides high on-axis intensity for excellent coupling efficiency.

Replaces

K6500 series
OP163 Series

Absolute Maximum Ratings ($T_A = 25^\circ\text{C}$ unless otherwise noted)

Reverse Voltage	2.0 V
Continuous Forward Current	50 mA
Peak Forward Current (1 μs pulse width, 300 pps)	3.0 A
Storage and Operating Temperature Range	-40°C to $+100^\circ\text{C}$
Lead Soldering Temperature [1/16 inch (1.6mm) from case for 5 sec. with soldering iron]	$260^\circ\text{C}^{(1)}$
Power Dissipation	$100\text{ mW}^{(2)}$

Notes:

- (1) RMA flux is recommended. Duration can be extended to 10 sec. max. when flow soldering. A max. of 20 grams force may be applied to the leads when soldering.
- (2) Derate linearly $1.33\text{ mW}/^\circ\text{C}$ above 25°C .
- (3) $E_{e(\text{APT})}$ is a measurement of the average apertured radiant incidence upon a sensing area $0.081''$ (2.06 mm) in diameter, perpendicular to and centered on the mechanical axis of the lens, and $0.590''$ (14.99 mm) from the measurement surface. $E_{e(\text{APT})}$ is not necessarily uniform within the measured area.

Typical Performance Curves

Percent Changes in Radiant Intensity vs Time

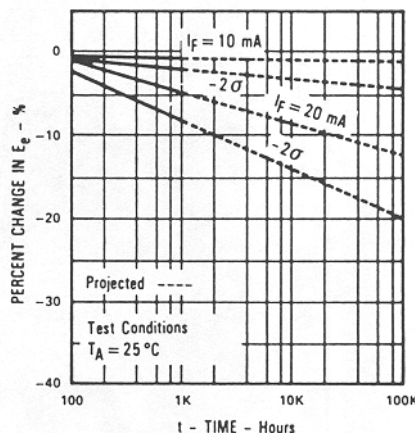

Coupling Characteristics OP165 and OP505

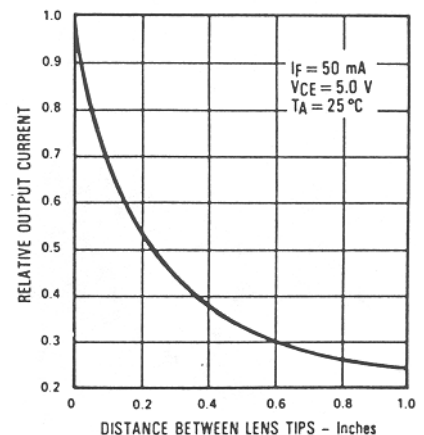

Types OP165A, OP165B, OP165C, OP165D

Electrical Characteristics ($T_A = 25^\circ\text{C}$ unless otherwise noted)

SYMBOL	PARAMETER	MIN	TYP	MAX	UNITS	TEST CONDITIONS
$E_e(\text{APT})$	Apertured Radiant Incidence	OP165D	0.28		1.60	mW/cm^2
		OP165C	0.85			mW/cm^2
		OP165B	1.40			mW/cm^2
		OP165A	1.95			mW/cm^2
V_F	Forward Voltage			1.60	V	$I_F = 20\text{ mA}$
I_R	Reverse Current			100	μA	$V_R = 2.0\text{ V}$
λ_p	Wavelength at Peak Emission		935		nm	$I_F = 10\text{ mA}$
B	Spectral Bandwidth Between Half Power Points		50		nm	$I_F = 10\text{ mA}$
$\Delta\lambda_p/\Delta T$	Spectral Shift with Temperature		+0.30		$\text{nm}/^\circ\text{C}$	$I_F = \text{Constant}$
θ_{HP}	Emission Angle at Half Power Points		18		Deg.	$I_F = 20\text{ mA}$
t_r	Output Rise Time		1000		ns	$I_{F(\text{PK})} = 100\text{ mA}$, PW = 10 μs , D.C. = 10%
t_f	Output Fall Time		500		ns	

Typical Performance Curves

Forward Voltage vs Forward Current

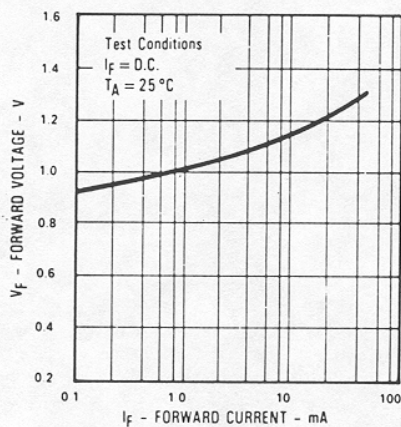

Forward Voltage and Relative Radiant Incidence vs. Forward Current

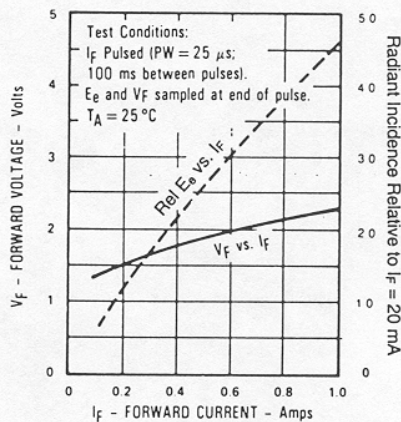

Forward Voltage vs Ambient Temperature

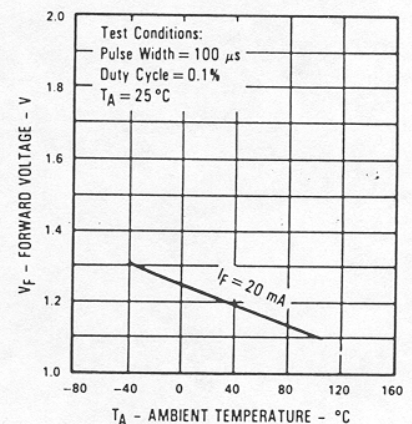

Rise Time and Fall Time vs Forward Current

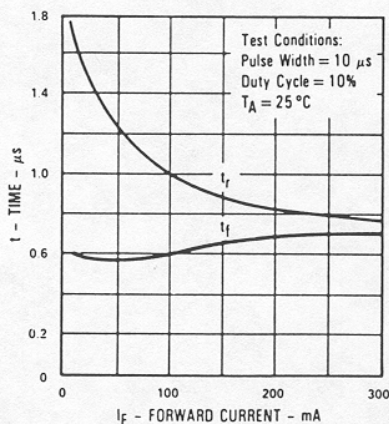

Relative Radiant Intensity and Wavelength at Peak Emission vs Ambient Temperature

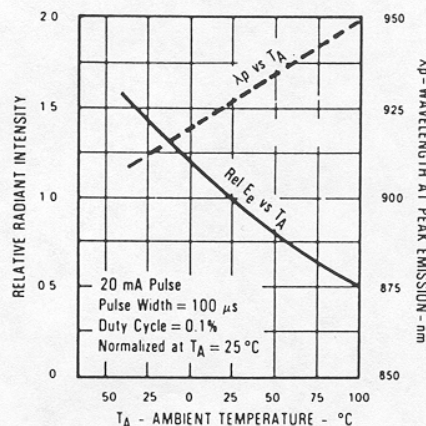

Relative Radiant Intensity vs Angular Displacement

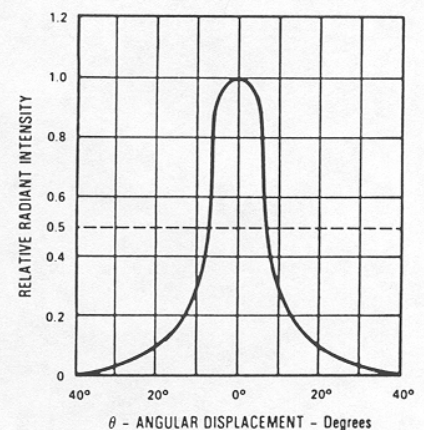

Optek reserves the right to make changes at any time in order to improve design and to supply the best product possible.

Optek Technology, Inc. 1215 W. Crosby Road Carrollton, Texas 75006 (972)323-2200 Fax (972)323-2396