



SANYO Semiconductors

DATA SHEET

Bi-CMOS LSI

LV8085CL — Two-channel H-Bridge Driver

Overview

The LV8085CL is a two-channel H-bridge driver that supports low-voltage operation. It is optimal for H-bridge drive of stepping motors (AF and zoom) in portable equipment such as camera cell phones.

Features

- Two-channel H-bridge driver
- Supports both 2-phase drive and 1-2 phase drive.
- Implemented in a low-power MOS IC process.
- Ultraminiature easy to solder ESCP2823-10 package
- Built-in thermal protection and low-voltage sensing circuits

Specifications

Absolute Maximum Ratings at $T_a = 25^\circ\text{C}$

Parameter	Symbol	Conditions	Ratings	Unit
Maximum supply voltage	V_{CC} max		6.5	V
Output voltage	V_{OUT} max	OUT1, OUT2, OUT3, OUT4	6.5	V
Input voltage	V_{IN} max	CONT, IN	-0.3 to +6.5	V
Ground pin source current	IGND	Per channel	400	mA
Allowable power dissipation	P_d max	Mounted on a circuit board.*	400	mW
Operating temperature	T_{opr}		-30 to +85	$^\circ\text{C}$
Storage temperature	T_{stg}		-40 to +150	$^\circ\text{C}$

* Specified circuit board : 20.0mm×10.0mm×0.8mm³, paper-phenol circuit board.

■ Any and all SANYO Semiconductor Co.,Ltd. products described or contained herein are, with regard to "standard application", intended for the use as general electronics equipment (home appliances, AV equipment, communication device, office equipment, industrial equipment etc.). The products mentioned herein shall not be intended for use for any "special application" (medical equipment whose purpose is to sustain life, aerospace instrument, nuclear control device, burning appliances, transportation machine, traffic signal system, safety equipment etc.) that shall require extremely high level of reliability and can directly threaten human lives in case of failure or malfunction of the product or may cause harm to human bodies, nor shall they grant any guarantee thereof. If you should intend to use our products for applications outside the standard applications of our customer who is considering such use and/or outside the scope of our intended standard applications, please consult with us prior to the intended use. If there is no consultation or inquiry before the intended use, our customer shall be solely responsible for the use.

■ Specifications of any and all SANYO Semiconductor Co.,Ltd. products described or contained herein stipulate the performance, characteristics, and functions of the described products in the independent state, and are not guarantees of the performance, characteristics, and functions of the described products as mounted in the customer's products or equipment. To verify symptoms and states that cannot be evaluated in an independent device, the customer should always evaluate and test devices mounted in the customer's products or equipment.

SANYO Semiconductor Co., Ltd.

TOKYO OFFICE Tokyo Bldg., 1-10, 1 Chome, Ueno, Taito-ku, TOKYO, 110-8534 JAPAN

LV8085CL

Allowable Operating Ratings at Ta = 25°C

Parameter	Symbol	Conditions	Ratings	Unit
Supply voltage	V _{CC}		2.5 to 6.0	V
High-level input voltage	V _{IH}	IN	0.6V _{CC}	V
Low-level input voltage	V _{IL}		-0.3 to 0.2V _{CC}	V

Electrical Characteristics at Ta = 25°C, V_{CC} = 3.0V

Parameter	Symbol	Conditions	Ratings			Unit
			min	typ	max	
Quiescent current	I _{CCO}	IN = 0V		0.1	1	μA
	I _{CCO1}	IN = 3V		0.45	0.7	mA
Output on resistance	Ron1	V _{CC} = 3.0V (High and low side total) IN1 to 4 = 3.0V, I _{OUT} = 100mA		2.1	3.0	Ω
	Ron2	V _{CC} = 5.0V (High and low side total) IN1 to 4 = 5.0V, I _{OUT} = 100mA		1.75	2.2	Ω
Output turn-on time	Trise			1.5	3.0	μs
Output turn-off time	Tfall			0.2	1.0	μs
Input current	I _{IN}	V _{IN} = 3V		30	70	μA

Package Dimensions

unit : mm (typ)

3334

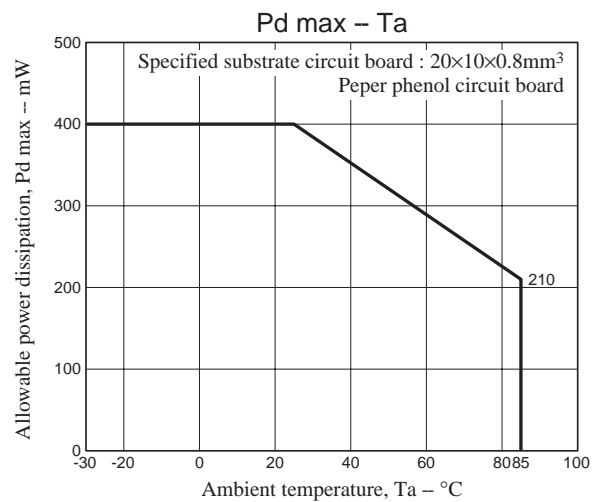
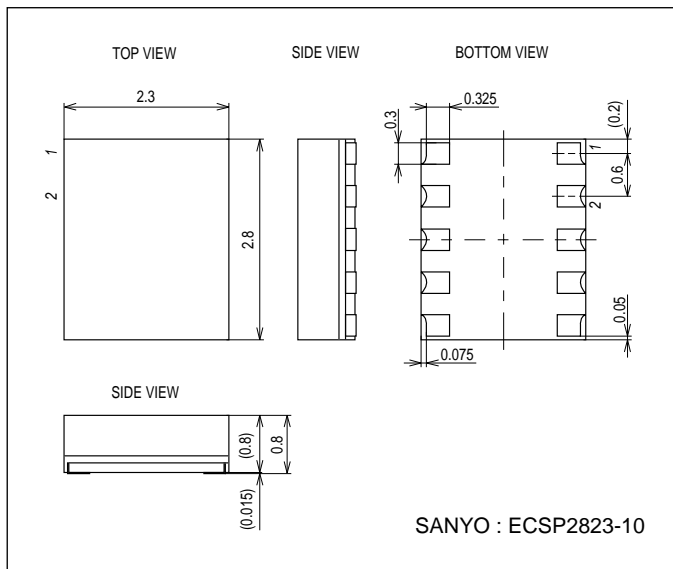

Pin Assignment

(ECSP2823-10)

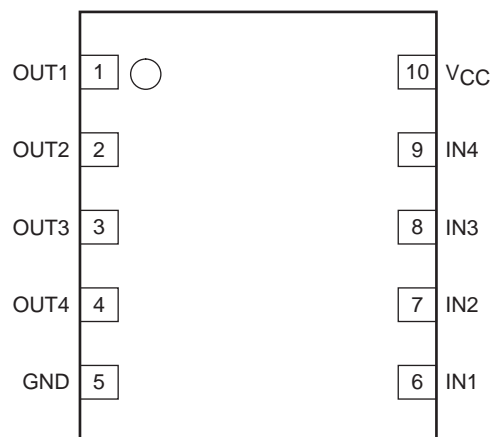

(Top View)

Block Diagram

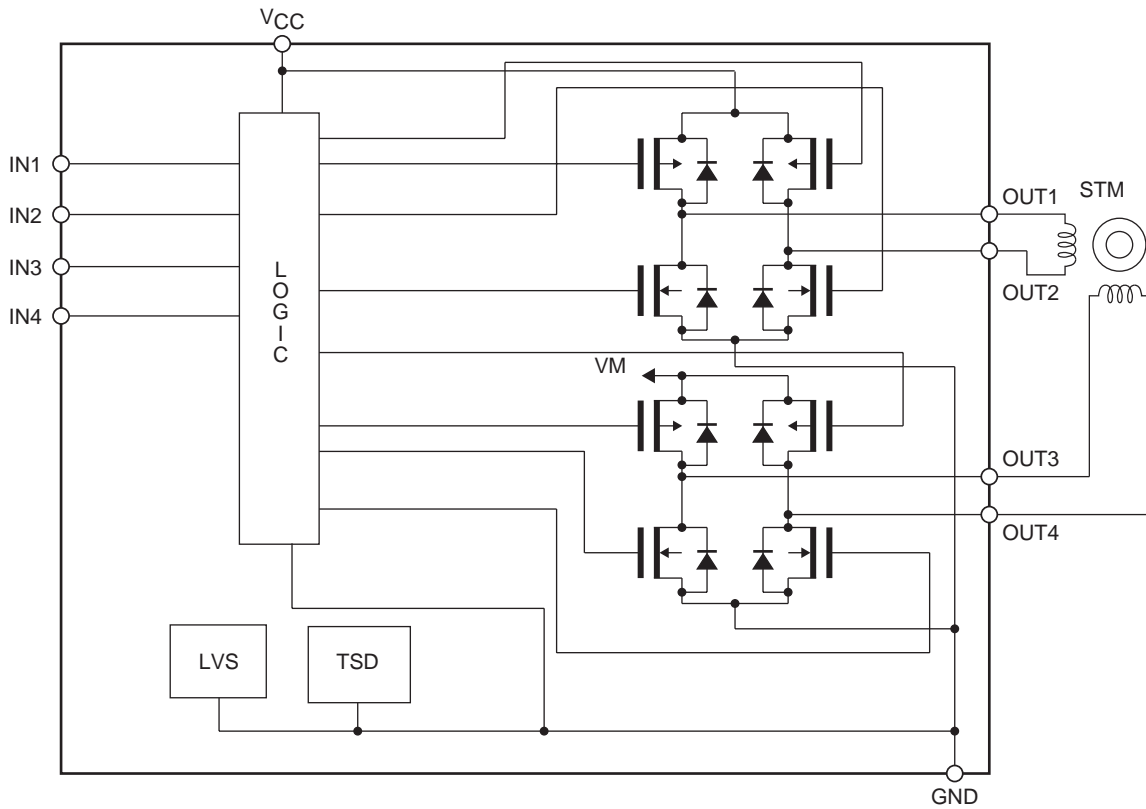

PCA01169

Usage Notes

Capacitor for the power supply stability must be connected between VCC and ground.

Truth Table

Input				Output				Mode
IN1	IN2	IN3	IN4	OUT1	OUT2	OUT3	OUT4	
Low	Low	Low	Low	Off	Off	Off	Off	Standby mode
Low	High	-	-	Low	High	Off	Off	Channel 1, reverse
High	Low			High	Low			Channel 1, forward
High	High			Low	Low			Channel 1, brake mode
-	-	Low	High	Off	Off	Low	High	Channel 2, reverse
		High	Low			High	Low	Channel 2, forward
		High	High			Low	Low	Channel 2, brake mode

Note : The "-" input unstable state. When off, a high-impedance state.

- The IC goes to the standby state with a low-level input, and to the operating state with a high-level input.

Timing Chart

(1) Stepper motor timing chart
Timing chart for 2-phase drive

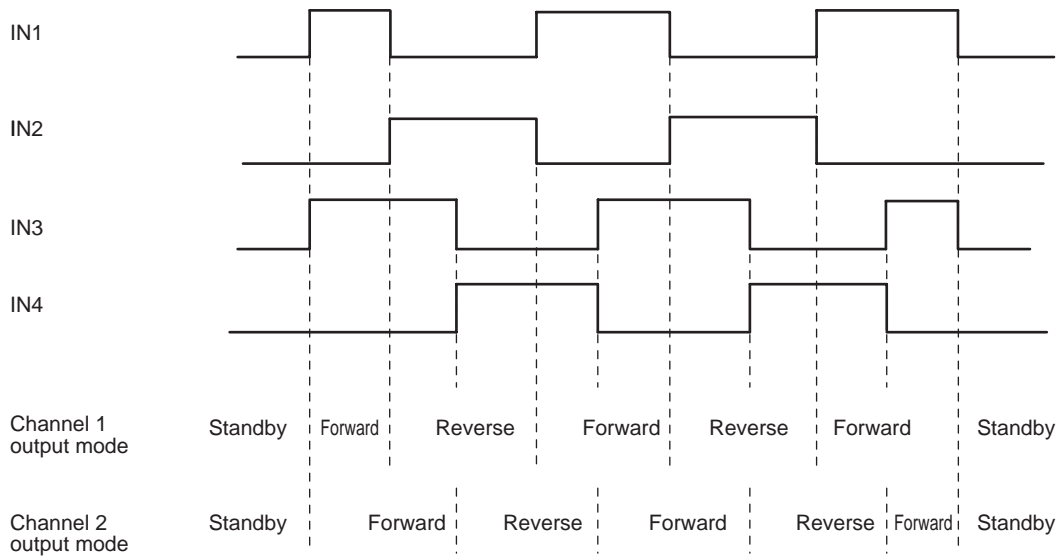

PCA01170

(2) Timing chart for 1-2 phase drive (Fastdecay mode)

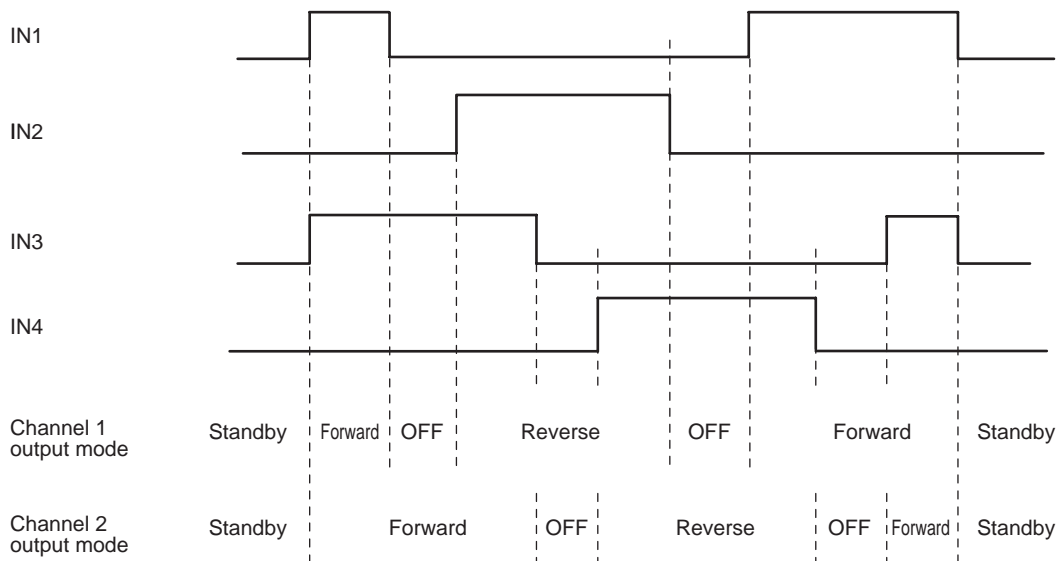

PCA01171

(3) Timing chart for 1-2 phase drive (Slow decay mode)

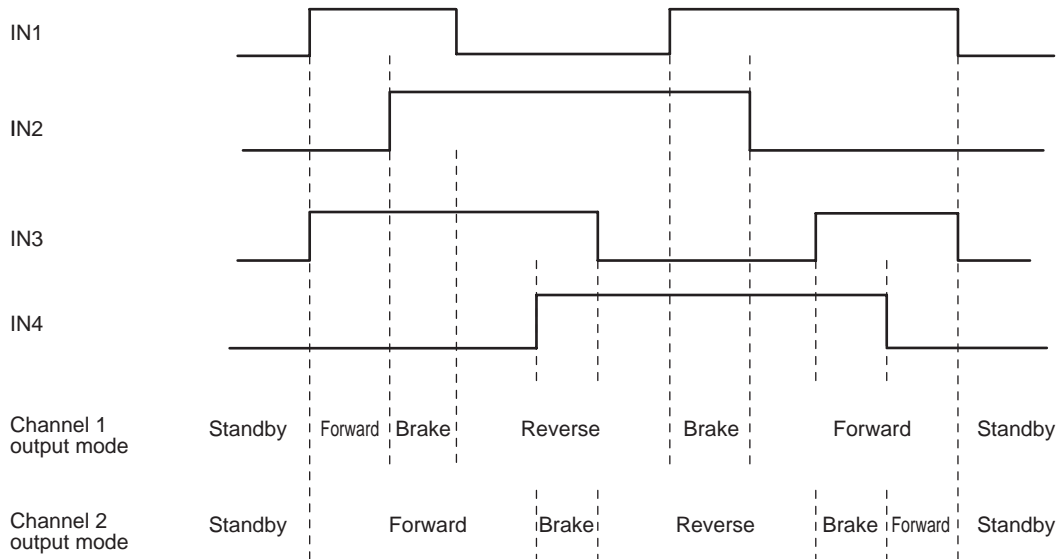

PCA01172

- SANYO Semiconductor Co.,Ltd. assumes no responsibility for equipment failures that result from using products at values that exceed, even momentarily, rated values (such as maximum ratings, operating condition ranges, or other parameters) listed in products specifications of any and all SANYO Semiconductor Co.,Ltd. products described or contained herein.
- SANYO Semiconductor Co.,Ltd. strives to supply high-quality high-reliability products, however, any and all semiconductor products fail or malfunction with some probability. It is possible that these probabilistic failures or malfunction could give rise to accidents or events that could endanger human lives, trouble that could give rise to smoke or fire, or accidents that could cause damage to other property. When designing equipment, adopt safety measures so that these kinds of accidents or events cannot occur. Such measures include but are not limited to protective circuits and error prevention circuits for safe design, redundant design, and structural design.
- In the event that any or all SANYO Semiconductor Co.,Ltd. products described or contained herein are controlled under any of applicable local export control laws and regulations, such products may require the export license from the authorities concerned in accordance with the above law.
- No part of this publication may be reproduced or transmitted in any form or by any means, electronic or mechanical, including photocopying and recording, or any information storage or retrieval system, or otherwise, without the prior written consent of SANYO Semiconductor Co.,Ltd.
- Any and all information described or contained herein are subject to change without notice due to product/technology improvement, etc. When designing equipment, refer to the "Delivery Specification" for the SANYO Semiconductor Co.,Ltd. product that you intend to use.
- Information (including circuit diagrams and circuit parameters) herein is for example only; it is not guaranteed for volume production.
- Upon using the technical information or products described herein, neither warranty nor license shall be granted with regard to intellectual property rights or any other rights of SANYO Semiconductor Co.,Ltd. or any third party. SANYO Semiconductor Co.,Ltd. shall not be liable for any claim or suits with regard to a third party's intellectual property rights which has resulted from the use of the technical information and products mentioned above.

This catalog provides information as of June, 2007. Specifications and information herein are subject to change without notice.