



SANYO Semiconductors

# DATA SHEET

## LV47002P — Monolithic Linear IC For Car Audio Systems 4-Channel BTL Power Amplifier

### Overview

The LV47002P is the IC for 4-channel BTL power amplifier that is developed for car audio system.

Pch DMOS in the upper side of the output stage and Nch DMOS in the lower side of the output stage are complimentary. High power and high quality sound are realized by that.

This IC incorporate various functions (standby switch, muting function, and various protection circuit) necessary for car audio system. Also, it has a self-diagnosis function.

### Functions

- High output :  $P_O$  max = 48W (typical) ( $V_{CC} = 15.2V$ ,  $f = 1kHz$ , JEITA max,  $R_L = 4\Omega$ )  
:  $P_O$  max = 28W (typical) ( $V_{CC} = 14.4V$ ,  $f = 1kHz$ , THD = 10%,  $R_L = 4\Omega$ )  
:  $P_O$  max = 21W (typical) ( $V_{CC} = 14.4V$ ,  $f = 1kHz$ , THD = 1%,  $R_L = 4\Omega$ )
- Built-in muting function (pin 22)
- Built-in Standby switch (pin 4)
- Built-in Self-diagnosis function (pin 25) :  
Signal output in case of output offset detection, shorting to  $V_{CC}$ , shorting to ground, and load shorting.
- Electric mirror noise decrease
- Built-in various protection circuit (shorting to ground, shorting to  $V_{CC}$ , load shorting, over voltage and thermal shut down)
- No external anti-oscillation part necessary.

Note 1 : Please do not mistake connection.

A wrong connection may produce destruction, deterioration and damage for the IC or equipment.

Note 2 : The protective circuit function is provided to temporarily avoid abnormal state such as incorrect output connection.

But, there is no guarantee that the IC is not destroyed by the accident.

The protective function do not operate of the operation guarantee range. If the outputs are connected incorrectly, IC destruction may occur when used outside of the operation guarantee range.

Note 3 : External parts, such as the anti-oscillation part, may become necessary depending on the set condition. Check their necessity for each set.

■ Any and all SANYO Semiconductor Co.,Ltd. products described or contained herein are, with regard to "standard application", intended for the use as general electronics equipment (home appliances, AV equipment, communication device, office equipment, industrial equipment etc.). The products mentioned herein shall not be intended for use for any "special application" (medical equipment whose purpose is to sustain life, aerospace instrument, nuclear control device, burning appliances, transportation machine, traffic signal system, safety equipment etc.) that shall require extremely high level of reliability and can directly threaten human lives in case of failure or malfunction of the product or may cause harm to human bodies, nor shall they grant any guarantee thereof. If you should intend to use our products for applications outside the standard applications of our customer who is considering such use and/or outside the scope of our intended standard applications, please consult with us prior to the intended use. If there is no consultation or inquiry before the intended use, our customer shall be solely responsible for the use.

■ Specifications of any and all SANYO Semiconductor Co.,Ltd. products described or contained herein stipulate the performance, characteristics, and functions of the described products in the independent state, and are not guarantees of the performance, characteristics, and functions of the described products as mounted in the customer's products or equipment. To verify symptoms and states that cannot be evaluated in an independent device, the customer should always evaluate and test devices mounted in the customer's products or equipment.

# LV47002P

## Specifications

### Maximum Ratings at Ta = 25°C

Parameter	Symbol	Conditions	Ratings	Unit
Maximum supply voltage	V <sub>CC</sub> max1	No signal, t = 1 minute	26	V
	V <sub>CC</sub> max2	During operations	18	V
Maximum output current	I <sub>O</sub> peak	Per channel	4.5/ch	A
Allowable power dissipation	P <sub>d</sub> max	With an infinity heat sink	50	W
Operating temperature	T <sub>opr</sub>		-40 to +85	°C
Storage temperature	T <sub>stg</sub>		-40 to +150	°C
Thermal resistance between the junction and case	θ <sub>j-c</sub>		1	°C/W

### Recommended Operating Ranges at Ta = 25°C

Parameter	Symbol	Conditions	Ratings	Unit
Recommended supply voltage	V <sub>CC</sub>		14.4	V
Recommended load resistance	R <sub>L</sub> op		4	Ω
Operating supply voltage range	V <sub>CC</sub> op	A range not exceeding P <sub>d</sub> max	9 to 16	V

### Electrical Characteristics at Ta = 25°C, V<sub>CC</sub> = 14.4V, R<sub>L</sub> = 4Ω, f = 1kHz, R<sub>g</sub> = 600Ω

Parameter	Symbol	Conditions	Ratings			Unit
			min	typ	max	
Quiescent current	I <sub>CCO</sub>	R <sub>L</sub> = ∞, R <sub>g</sub> = 0Ω		200	400	mA
Standby current	I <sub>st</sub>	V <sub>st</sub> = 0V			10	μA
Voltage gain	V <sub>G</sub>	V <sub>O</sub> = 0dBm	25	26	27	dB
Voltage gain difference	ΔV <sub>G</sub>		-1		+1	dB
Output power	P <sub>O</sub>	THD = 10%	23	28		W
	P <sub>O</sub> max1	JEITA max		43		W
	P <sub>O</sub> max2	V <sub>CC</sub> = 15.2, JEITA max		48		W
Output offset voltage	V <sub>n</sub> offset	R <sub>g</sub> = 0Ω	-100		+100	mV
Total harmonic distortion	THD	P <sub>O</sub> = 4W		0.03	0.2	%
Channel separation	CHsep	V <sub>O</sub> = 0dBm, R <sub>g</sub> = 10kΩ	55	65		dB
Ripple rejection ratio	SVRR	R <sub>g</sub> = 0Ω, fr = 100Hz, V <sub>CC</sub> R = 0dBm	45	65		dB
Output noise voltage	V <sub>NO</sub>	R <sub>g</sub> = 0Ω, B.P.F. = 20Hz to 20kHz		80	200	μVrms
Input resistance	R <sub>i</sub>		40	50	65	kΩ
Mute attenuation	Matt	V <sub>O</sub> = 20dBm, mute : on	75	90		dB
Standby pin control voltage	V <sub>stby</sub> H	Amp : on	2.5		V <sub>CC</sub>	V
	V <sub>stby</sub> L	Amp : off	0.0		0.5	V
Mute pin control voltage	V <sub>mute</sub> H	Mute : off	Open			-
	V <sub>mute</sub> L	Mute : on	0.0		1.5	V
<b>Output offset detection</b>						
Detection threshold voltage	V <sub>osdet</sub>		±1.2	±1.8	±2.4	V

\* 0dBm = 0.775Vrms

# LV47002P

## Package Dimensions

unit : mm (typ)  
3236A

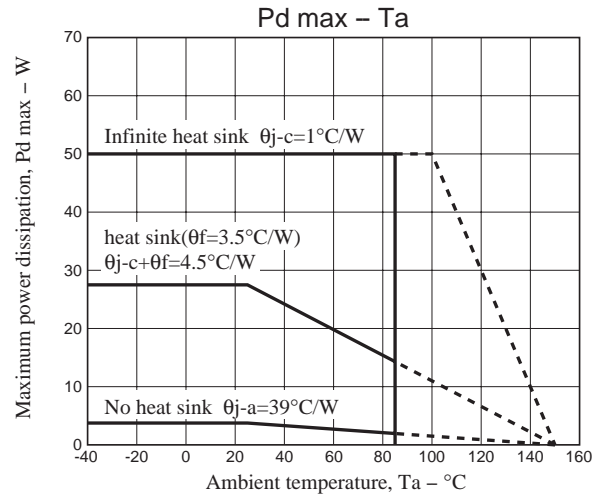
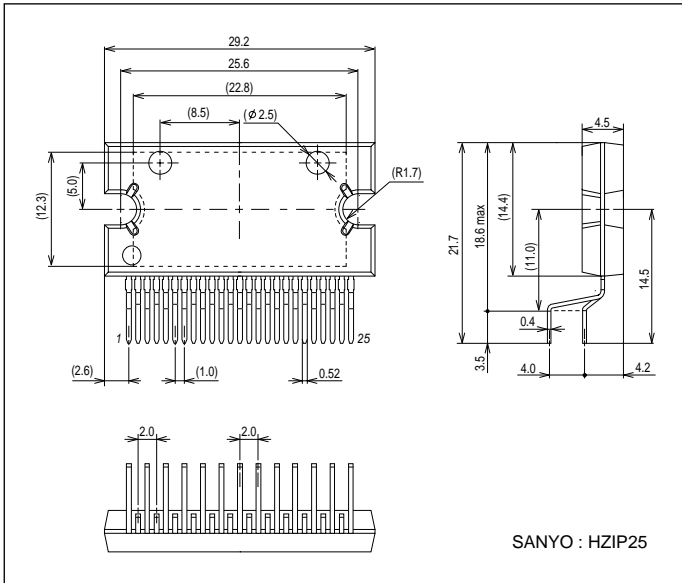

## Block Diagram

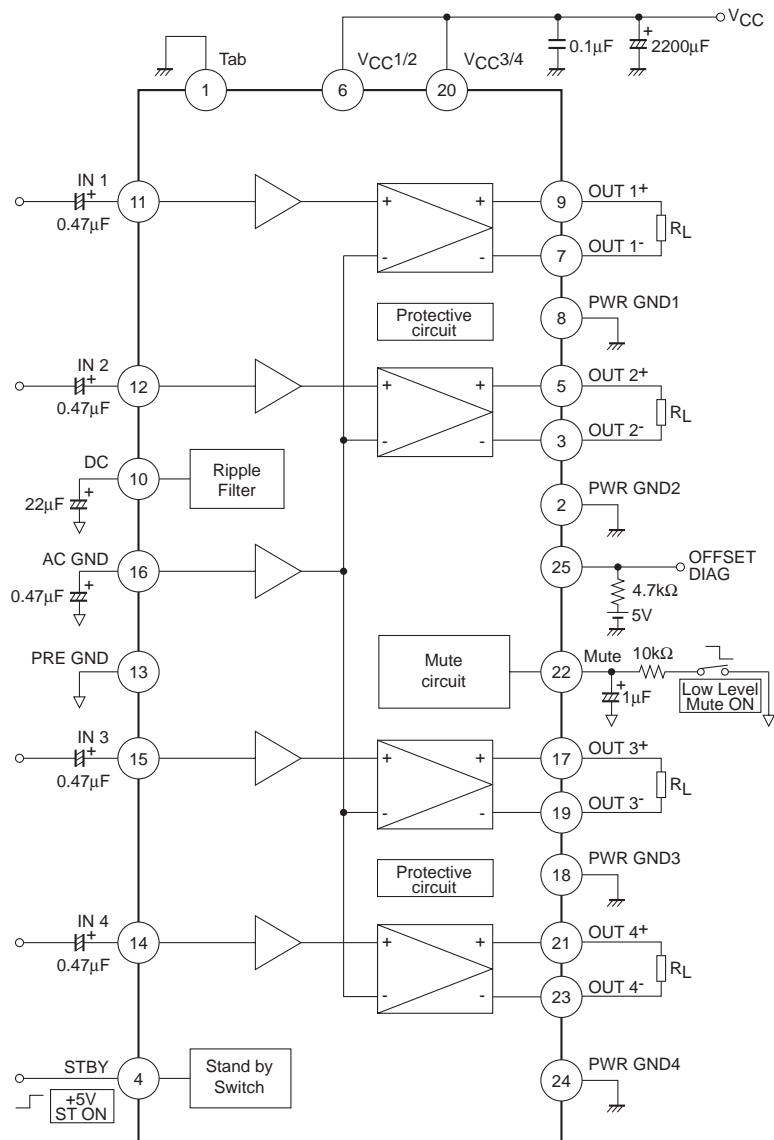



# LV47002P

## 4. Self-diagnostics function (pin 25)

By detecting the unusual state of the IC, the signal is output to the pin 25.

Also, by controlling the standby switch after the signal of the pin 25 is detected by the microcomputer, the burnout of the speaker can be prevented.

- (1) Shorting to  $V_{CC}$ /Shorting to ground : The pin 25 becomes the low level.
- (2) Load shorting : The pin 25 is alternated between the low level and the high level according to the output signal.
- (3) Output offset detection : when the output offset voltage exceeds the detection threshold voltage, the pin 25 becomes the low level.

\* Note: The output offset abnormality is thought of as the leakage current of the input capacitor.

In addition, the pin 25 has become the NPN open collector output (active low).

The pin 25 must be left open when this function is not used.

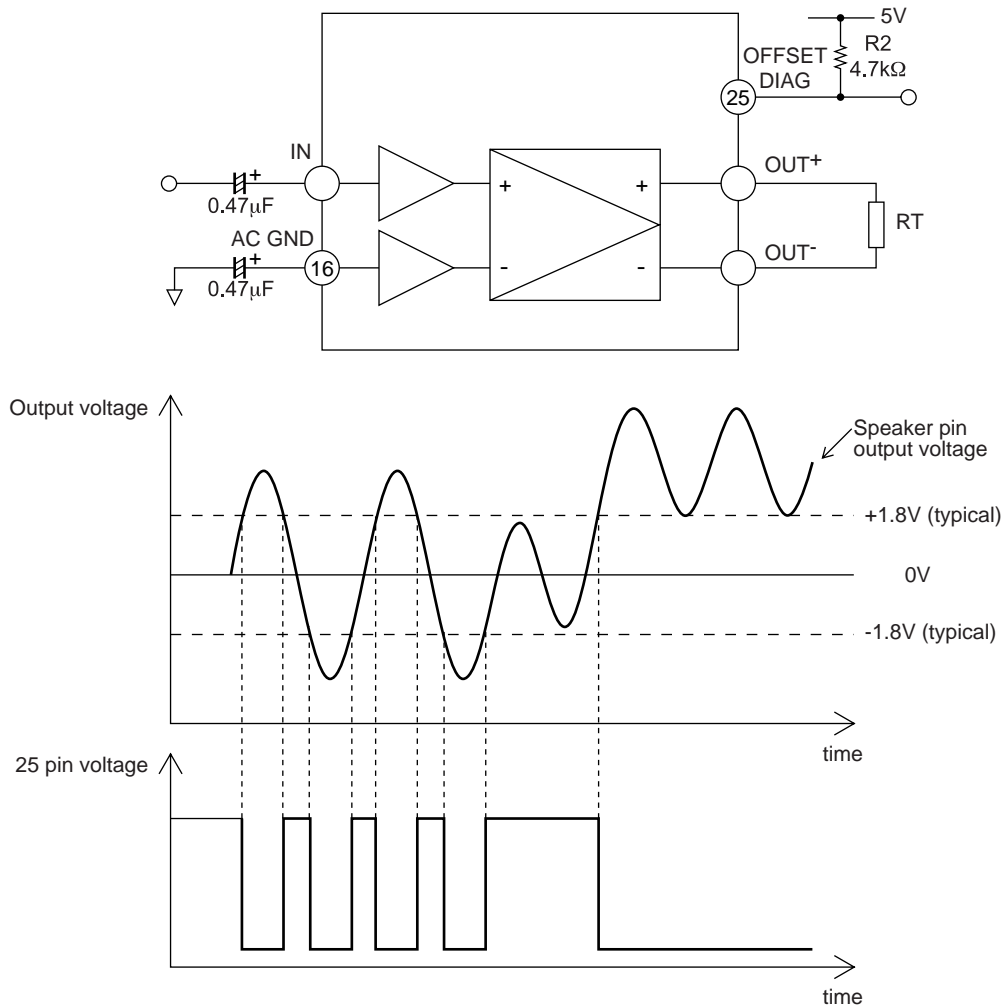

Fig3 Self-diagnosis Function Diagram

### 5. Sound quality (low frequencies)

By varying the value of input capacitor, low-frequency characteristic can be improved.  
However, it is concerned the shock noise. Please confirm in each set when the capacitance value varies.

### 6. Pop noise

For pop noise prevention, it is recommended to use the muting function at the same time.

- Please turn on the muting function simultaneously with power supply on when the amplifier is turned on. Next, turn off the muting function after the output DC potential stabilization.
- When the amplifier is turn off, turn off the power supply after turning on the muting function.

### 7. Oscillation stability

Pay due attention on the following points because parasitic oscillation may occur due to effects of the capacity load, board layout, etc.

#### (1) Capacity load

When the capacitor is to be inserted between each output pin and GND so as to prevent electric mirror noise, select the capacitance of maximum 1500pF. (Conditions : Our recommended board,  $R_L = 4\Omega$ )

#### (2) Board layout

- Provide the  $V_{CC}$  capacitor of 0.1 $\mu$ F in the position nearest to IC.
- PREGND must be independently wired and connected to the GND point that is as stable as possible, such as the minus pin of the 2200 $\mu$ F  $V_{CC}$  capacitor.

In case of occurrence of parasitic oscillation, any one of following parts may be added as a countermeasure.

Note that the optimum capacitance must be checked for each set in the mounted state.

- Series connection of CR (0.1 $\mu$ F and 2.2 $\Omega$ ) between BTL outputs
- Series connection of CR(0.1 $\mu$ F and 2.2 $\Omega$ ) between each output pin and GND.

# LV47002P

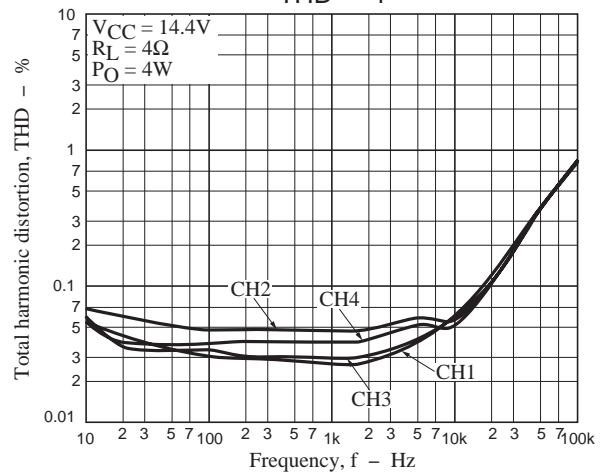
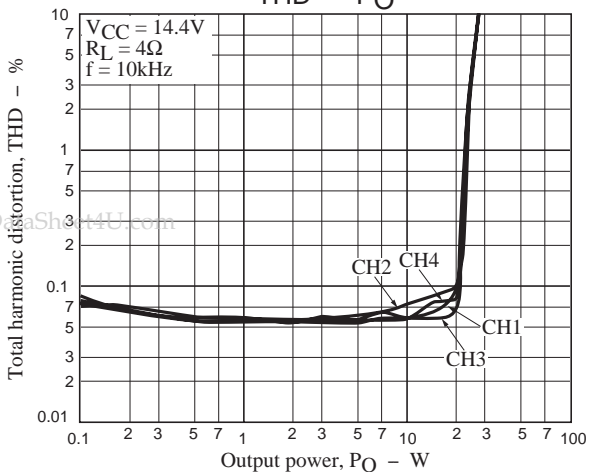
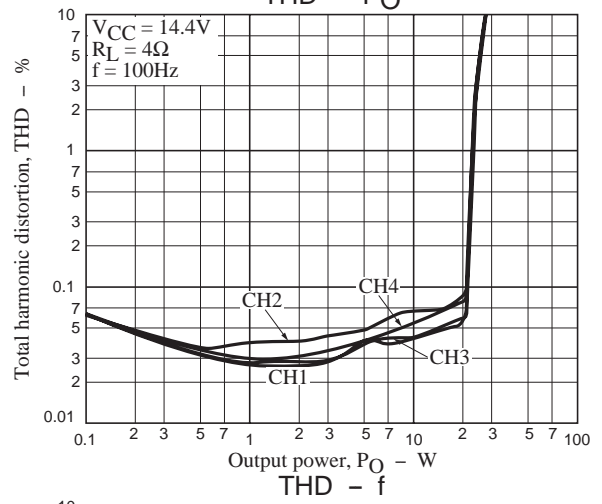
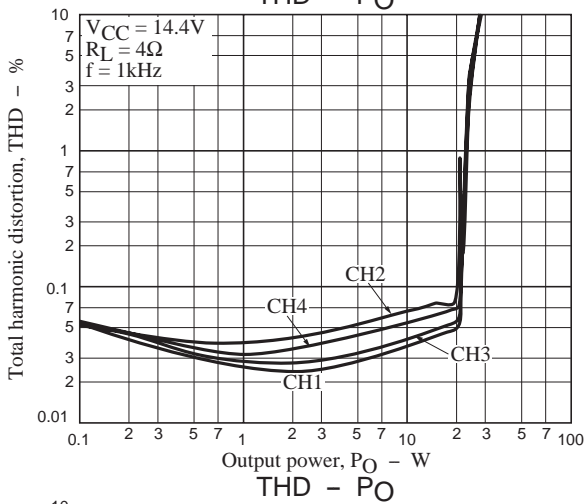
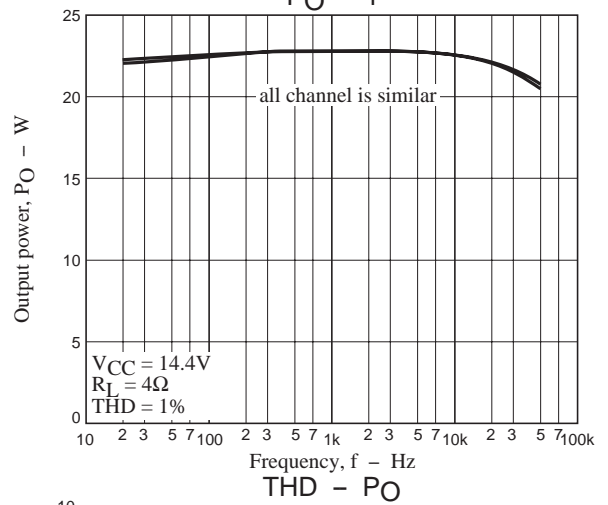
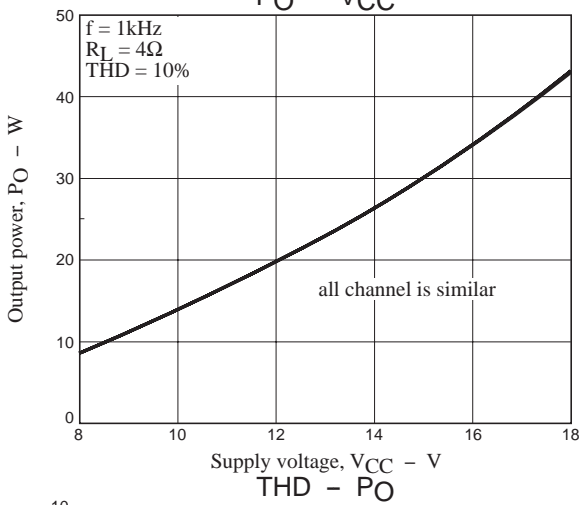
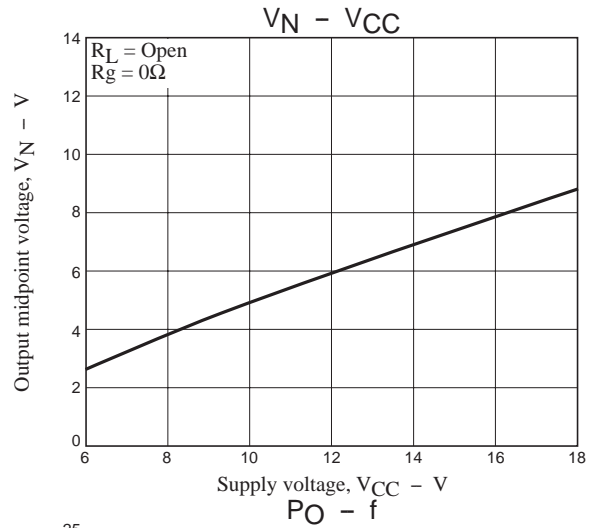
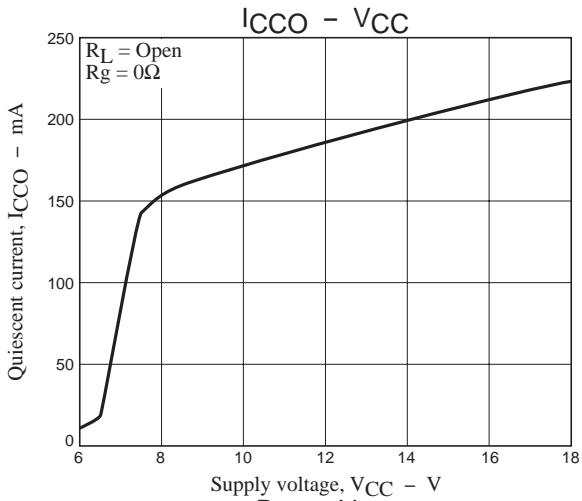

# LV47002P

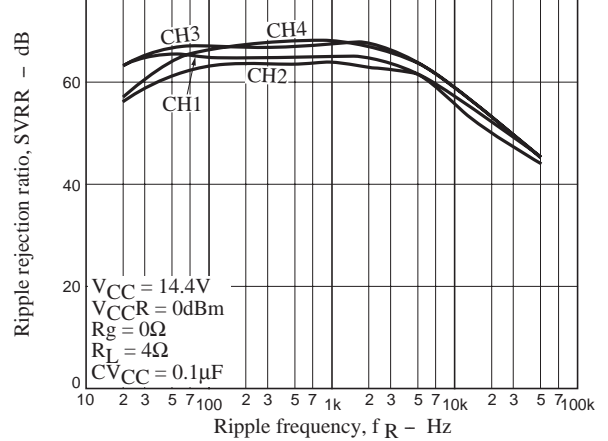
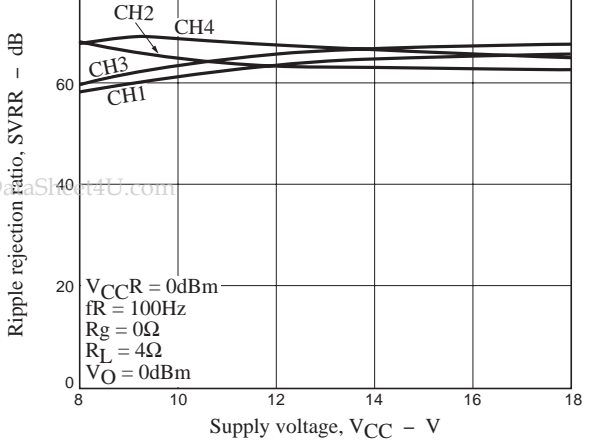
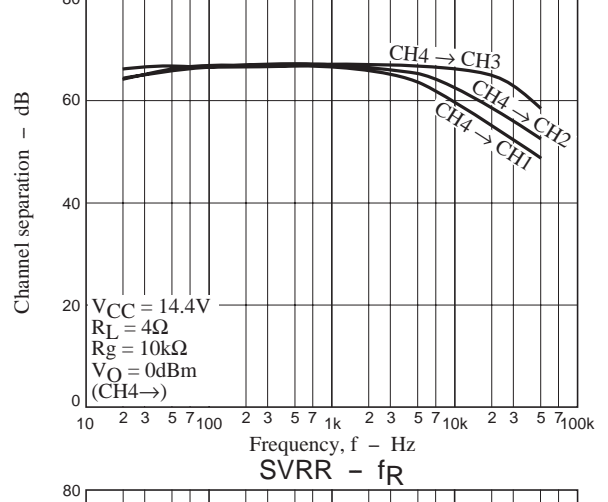
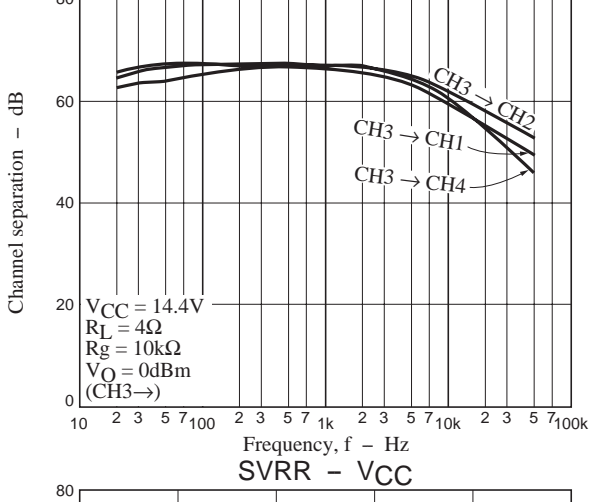
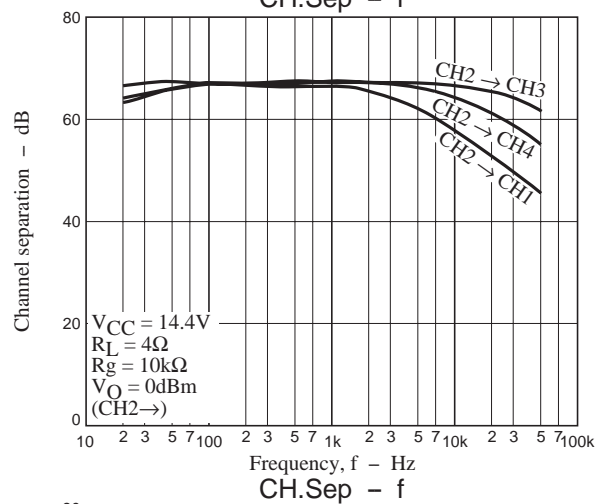
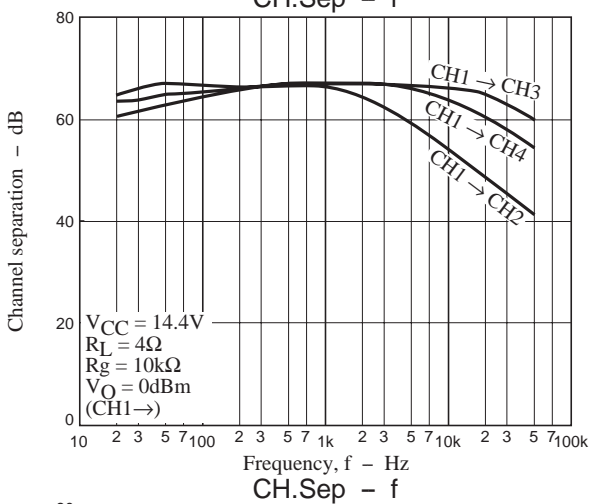
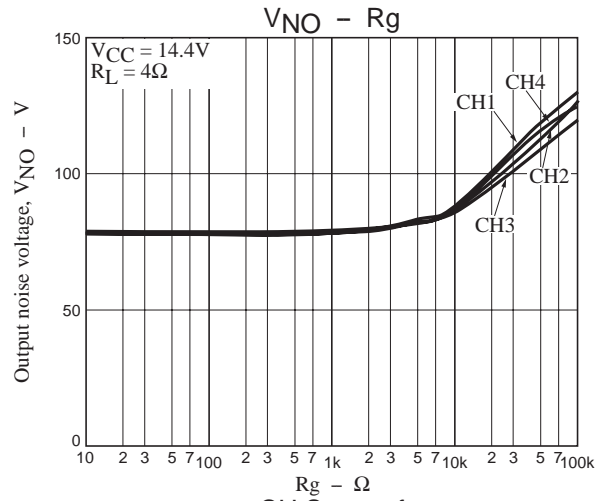
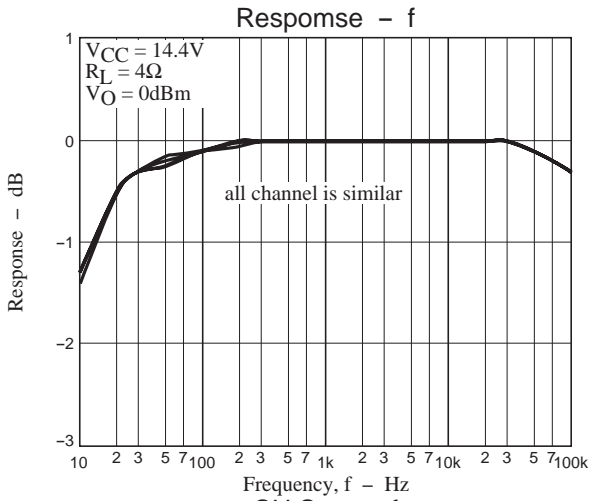



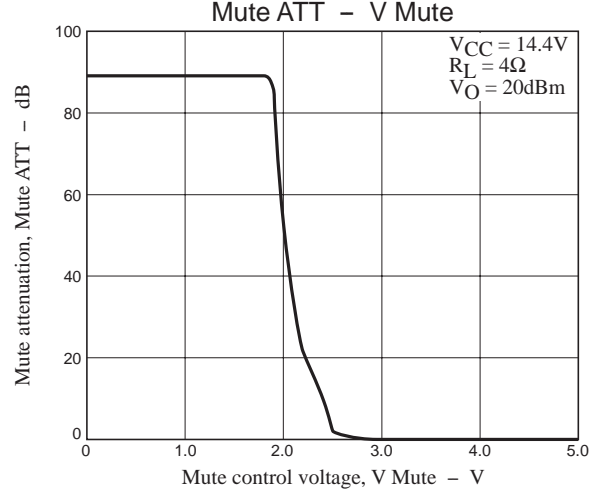
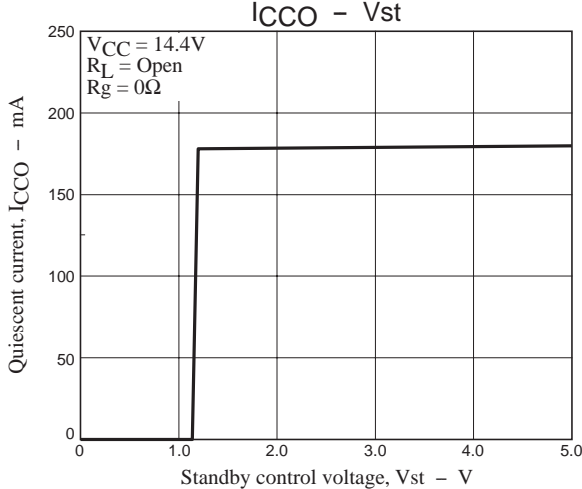
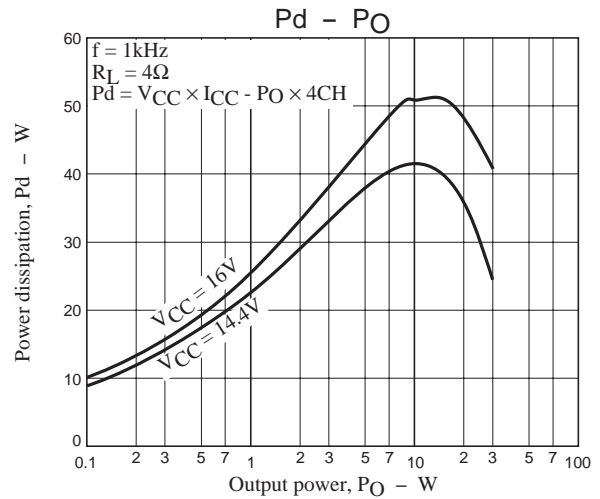
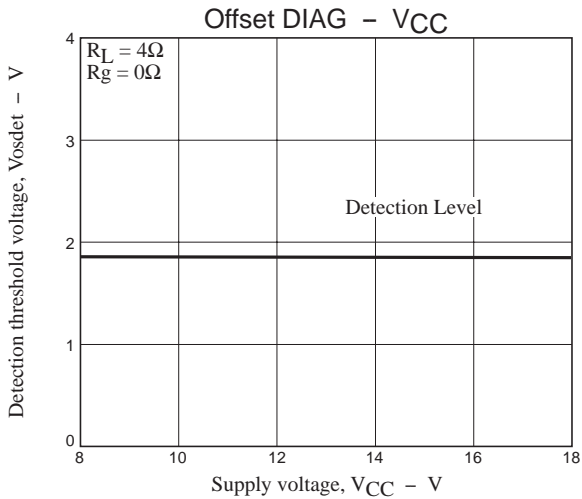

- SANYO Semiconductor Co.,Ltd. assumes no responsibility for equipment failures that result from using products at values that exceed, even momentarily, rated values (such as maximum ratings, operating condition ranges, or other parameters) listed in products specifications of any and all SANYO Semiconductor Co.,Ltd. products described or contained herein.
- SANYO Semiconductor Co.,Ltd. strives to supply high-quality high-reliability products, however, any and all semiconductor products fail or malfunction with some probability. It is possible that these probabilistic failures or malfunction could give rise to accidents or events that could endanger human lives, trouble that could give rise to smoke or fire, or accidents that could cause damage to other property. When designing equipment, adopt safety measures so that these kinds of accidents or events cannot occur. Such measures include but are not limited to protective circuits and error prevention circuits for safe design, redundant design, and structural design.
- In the event that any or all SANYO Semiconductor Co.,Ltd. products described or contained herein are controlled under any of applicable local export control laws and regulations, such products may require the export license from the authorities concerned in accordance with the above law.
- No part of this publication may be reproduced or transmitted in any form or by any means, electronic or mechanical, including photocopying and recording, or any information storage or retrieval system, or otherwise, without the prior written consent of SANYO Semiconductor Co.,Ltd.
- Any and all information described or contained herein are subject to change without notice due to product/technology improvement, etc. When designing equipment, refer to the "Delivery Specification" for the SANYO Semiconductor Co.,Ltd. product that you intend to use.
- Information (including circuit diagrams and circuit parameters) herein is for example only; it is not guaranteed for volume production.
- Upon using the technical information or products described herein, neither warranty nor license shall be granted with regard to intellectual property rights or any other rights of SANYO Semiconductor Co.,Ltd. or any third party. SANYO Semiconductor Co.,Ltd. shall not be liable for any claim or suits with regard to a third party's intellectual property rights which has resulted from the use of the technical information and products mentioned above.

This catalog provides information as of August, 2009. Specifications and information herein are subject to change without notice.