

# Sensitive Triacs

## (0.8 A to 8 A)

### General Description

Teccor's line of sensitive gate triacs includes devices with current capabilities through 8 A. Voltage ranges are available from 200 V to 600 V. This line features devices with guaranteed gate control in Quadrants II and IV as well as control in the commonly used Quadrants I and III. Four-quadrant control devices require sensitive gate triacs. They can be controlled by digital circuitry where positive-only or negative-only pulses must control AC current in both directions through the device. Note that triacs with low  $I_{GT}$  values in Quadrants II and IV will have lower  $dv/dt$  characteristics.

The sensitive gate triac is a bidirectional AC switch and is gate controlled for either polarity of main terminal voltage. It is used primarily for AC switching and phase control applications such as motor speed controls, temperature modulation controls, and lighting controls.

The epoxy TO-92 and TO-220 configurations feature Teccor's electrically-isolated construction where the case or mounting tab is internally isolated from the semiconductor chip and lead attachments. Non-isolated epoxy TO-202 packages are available as well as TO-251 and surface mount TO-252 (D-Pak). Tape-and-reel capability and tube packing also are available. See "Packing Options" section of this catalog.

All Teccor triacs have glass-passivated junctions. This glassing process prevents migration of contaminants and ensures long-term device reliability with parameter stability.

Variations of devices covered in this data sheet are available for custom design applications. Consult factory for more information.

### Features

- Electrically-isolated packages
- Glass-passivated junctions ensure long device reliability and parameter stability
- Voltage capability — up to 600 V
- Surge capability — up to 80 A
- Four-quadrant gating guaranteed

### Compak Sensitive Gate Triac

- Surface mount package — 0.8 A and 1 A series
- New small profile three-leaded Compak package
- Packaged in embossed carrier tape with 2,500 devices per reel
- Can replace SOT-223

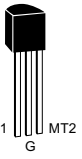
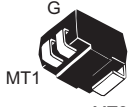
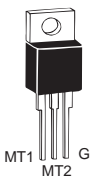
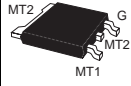
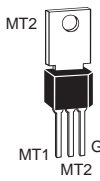
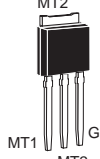
I <sub>T(RMS)</sub> (11)	Part No.						V <sub>DRM</sub> (1)	I <sub>GT</sub> (3) (6) (9)				I <sub>DRM</sub> (1) (14)	
	Isolated			Non-isolated				mAmps				mAmps	
								QI	QII	QIII	QIV	T <sub>C</sub> = 25 °C	T <sub>C</sub> = 110 °C
	TO-92	Compak	TO-220	TO-252 D-Pak	TO-202	TO-251 V-Pak	Volts						
MAX	See "Package Dimensions" section for variations. (12)						MIN	MAX				MAX	
0.8 A	L2X8E3	L2X3					200	3	3	3	3	0.01	0.1
	L4X8E3	L4X3					400	3	3	3	3	0.01	0.1
	L6X8E3	L6X3					600	3	3	3	3	0.01	0.1
	L2X8E5	L2X5					200	5	5	5	5	0.01	0.1
	L4X8E5	L4X5					400	5	5	5	5	0.01	0.1
	L6X8E5	L6X5					600	5	5	5	5	0.01	0.1
	L2X8E6						200	5	5	5	10	0.01	0.1
	L4X8E6						400	5	5	5	10	0.01	0.1
	L6X8E6						600	5	5	5	10	0.01	0.1
	L2X8E8						200	10	10	10	20	0.01	0.1
L4X8E8						400	10	10	10	20	0.01	0.1	
L6X8E8						600	10	10	10	20	0.01	0.1	
1 A	L201E3	L2N3					200	3	3	3	3	0.01	0.1
	L401E3	L4N3					400	3	3	3	3	0.01	0.1
	L601E3	L6N3					600	3	3	3	3	0.01	0.1
	L201E5	L2N5					200	5	5	5	5	0.01	0.1
	L401E5	L4N5					400	5	5	5	5	0.01	0.1
	L601E5	L6N5					600	5	5	5	5	0.01	0.1
	L201E6						200	5	5	5	10	0.01	0.1
	L401E6						400	5	5	5	10	0.01	0.1
	L601E6						600	5	5	5	10	0.01	0.1
	L201E8						200	10	10	10	20	0.01	0.1
L401E8						400	10	10	10	20	0.01	0.1	
L601E8						600	10	10	10	20	0.01	0.1	
4 A		L2004L3	L2004D3	L2004F31	L2004V3		200	3	3	3	3	0.01	0.2
		L4004L3	L4004D3	L4004F31	L4004V3		400	3	3	3	3	0.01	0.2
		L6004L3	L6004D3	L6004F31	L6004V3		600	3	3	3	3	0.01	0.2
		L2004L5	L2004D5	L2004F51	L2004V5		200	5	5	5	5	0.01	0.2
		L4004L5	L4004D5	L4004F51	L4004V5		400	5	5	5	5	0.01	0.2
		L6004L5	L6004D5	L6004F51	L6004V5		600	5	5	5	5	0.01	0.2
		L2004L6	L2004D6	L2004F61	L2004V6		200	5	5	5	10	0.01	0.2
		L4004L6	L4004D6	L4004F61	L4004V6		400	5	5	5	10	0.01	0.2
		L6004L6	L6004D6	L6004F61	L6004V6		600	5	5	5	10	0.01	0.2
		L2004L8	L2004D8	L2004F81	L2004V8		200	10	10	10	20	0.01	0.2
	L4004L8	L4004D8	L4004F81	L4004V8		400	10	10	10	20	0.01	0.2	
	L6004L8	L6004D8	L6004F81	L6004V8		600	10	10	10	20	0.01	0.2	

See "General Notes" on page E1 - 4 and "Electrical Specification Notes" on page E1 - 5.

$V_{TM}$	$V_{GT}$	$I_H$	$I_{GTM}$	$P_{GM}$	$P_{G(AV)}$	$I_{TSM}$	$dv/dt(c)$	$dv/dt$	$t_{gt}$	$I^2t$	$di/dt$
(1) (4)	(2) (5) (15)	(1) (7)	(13)	(13)		(8) (10)	(1) (10)	(1)	(9)		
Volts	Volts					Amps		Volts/ $\mu$ Sec			
$T_C = 25^\circ C$	$T_C = 25^\circ C$	mAmps	Amps	Watts	Watts	60/50 Hz	Volts/ $\mu$ Sec	$T_C = 100^\circ C$	$\mu$ Sec	Amps <sup>2</sup> Sec	Amps/ $\mu$ Sec
MAX	MAX	MAX					TYP	TYP	TYP		
1.6	2	5	1	10	0.2	10/8.3	0.5	20	2.8	0.41	20
1.6	2	5	1	10	0.2	10/8.3	0.5	15	2.8	0.41	20
1.6	2	5	1	10	0.2	10/8.3	0.5	10	2.8	0.41	20
1.6	2	10	1	10	0.2	10/8.3	1	20	3	0.41	20
1.6	2	10	1	10	0.2	10/8.3	1	15	3	0.41	20
1.6	2	10	1	10	0.2	10/8.3	1	10	3	0.41	20
1.6	2	10	1	10	0.2	10/8.3	1	30	3	0.41	20
1.6	2	10	1	10	0.2	10/8.3	1	25	3	0.41	20
1.6	2	10	1	10	0.2	10/8.3	1	20	3	0.41	20
1.6	2	15	1	10	0.2	10/8.3	2	35	3.2	0.41	20
1.6	2	15	1	10	0.2	10/8.3	2	30	3.2	0.41	20
1.6	2	15	1	10	0.2	10/8.3	2	25	3.2	0.41	20
1.6	2	5	1	10	0.2	20/16.7	0.5	20	2.8	1.6	20
1.6	2	5	1	10	0.2	20/16.7	0.5	20	2.8	1.6	20
1.6	2	5	1	10	0.2	20/16.7	0.5	10	2.8	1.6	20
1.6	2	10	1	10	0.2	20/16.7	1	20	3	1.6	20
1.6	2	10	1	10	0.2	20/16.7	1	20	3	1.6	20
1.6	2	10	1	10	0.2	20/16.7	1	10	3	1.6	20
1.6	2	10	1	10	0.2	20/16.7	1	30	3	1.6	20
1.6	2	10	1	10	0.2	20/16.7	1	30	3	1.6	20
1.6	2	10	1	10	0.2	20/16.7	1	20	3	1.6	20
1.6	2	15	1	10	0.2	20/16.7	1	35	3.2	1.6	20
1.6	2	15	1	10	0.2	20/16.7	1	35	3.2	1.6	20
1.6	2	15	1	10	0.2	20/16.7	1	25	3.2	1.6	20
1.6	2	5	1.2	15	0.3	40/33	0.5	25	2.8	6.6	50
1.6	2	5	1.2	15	0.3	40/33	0.5	25	2.8	6.6	50
1.6	2	5	1.2	15	0.3	40/33	0.5	15	2.8	6.6	50
1.6	2	10	1.2	15	0.3	40/33	1	25	3	6.6	50
1.6	2	10	1.2	15	0.3	40/33	1	25	3	6.6	50
1.6	2	10	1.2	15	0.3	40/33	1	15	3	6.6	50
1.6	2	10	1.2	15	0.3	40/33	1	30	3	6.6	50
1.6	2	10	1.2	15	0.3	40/33	1	30	3	6.6	50
1.6	2	10	1.2	15	0.3	40/33	1	20	3	6.6	50
1.6	2	15	1.2	15	0.3	40/33	2	35	3.2	6.6	50
1.6	2	15	1.2	15	0.3	40/33	2	35	3.2	6.6	50
1.6	2	15	1.2	15	0.3	40/33	2	25	3.2	6.6	50

See "General Notes" on page E1 - 4 and "Electrical Specification Notes" on page E1 - 5.

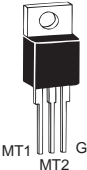
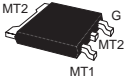
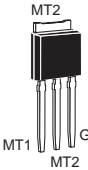
$I_{T(RMS)}$ (11)	Part No.			$V_{DRM}$ (1)	$I_{GT}$ (3) (6)				$I_{DRM}$ (1) (14)	
	Isolated	Non-isolated			mAmps				mAmps	
	 TO-220	 TO-252 D-Pak	 TO-251 V-Pak	Volts	QI	QII	QIII	QIV	$T_C = 25\text{ }^\circ\text{C}$	$T_C = 110\text{ }^\circ\text{C}$
MAX	See "Package Dimensions" section for variations. (12)			MIN	MAX				MAX	
6 A	L2006L5	L2006D5	L2006V5	200	5	5	5	5	0.02	0.5
	L4006L5	L4006D5	L4006V5	400	5	5	5	5	0.02	0.5
	L6006L5	L6006D5	L6006V5	600	5	5	5	5	0.02	0.5
	L2006L6	L2006D6	L2006V6	200	5	5	5	10	0.02	0.5
	L4006L6	L4006D6	L4006V6	400	5	5	5	10	0.02	0.5
	L6006L6	L6006D6	L6006V6	600	5	5	5	10	0.02	0.5
	L2006L8	L2006D8	L2006V8	200	10	10	10	20	0.02	0.5
8 A	L4006L8	L4006D8	L4006V8	400	10	10	10	20	0.02	0.5
	L6006L8	L6006D8	L6006V8	600	10	10	10	20	0.02	0.5
	L2008L6	L2008D6	L2008V6	200	5	5	5	10	0.02	0.5
	L4008L6	L4008D6	L4008V6	400	5	5	5	10	0.02	0.5
	L6008L6	L6008D6	L6008V6	600	5	5	5	10	0.02	0.5
	L2008L8	L2008D8	L2008V8	200	10	10	10	20	0.02	0.5
	L4008L8	L4008D8	L4008V8	400	10	10	10	20	0.02	0.5
L6008L8	L6008D8	L6008V8	600	10	10	10	20	0.02	0.5	

### Specified Test Conditions

$di/dt$  — Maximum rate-of-change of on-state current;  $I_{GT} = 50\text{ mA}$  with  $0.1\text{ }\mu\text{s}$  rise time

$dv/dt$  — Critical rate-of-rise of off-state voltage at rated  $V_{DRM}$  gate open

$dv/dt(c)$  — Critical rate-of-rise of commutation voltage at rated  $V_{DRM}$  and  $I_{T(RMS)}$  commutating  $di/dt = 0.54$  rated  $I_{T(RMS)}/\text{ms}$ ; gate unenergized

$I^2t$  — RMS surge (non-repetitive) on-state current for period of 8.3 ms for fusing

$I_{DRM}$  — Peak off-state current, gate open;  $V_{DRM} = \text{max rated value}$

$I_{GT}$  — DC gate trigger current in specific operating quadrants;  $V_D = 12\text{ V dc}$ ;  $R_L = 60\text{ }\Omega$

$I_{GTM}$  — Peak gate trigger current

$I_H$  — Holding current gate open; initial on-state current =  $100\text{ mA dc}$

$I_{T(RMS)}$  — RMS on-state current conduction angle of  $360^\circ$

$I_{TSM}$  — Peak one-cycle surge

$P_{G(AV)}$  — Average gate power dissipation

$P_{GM}$  — Peak gate power dissipation;  $I_{GT} \leq I_{GTM}$

$t_{gt}$  — Gate controlled turn-on time;  $I_{GT} = 50\text{ mA}$  with  $0.1\text{ }\mu\text{s}$  rise time

$V_{DRM}$  — Repetitive peak off-state/blocking voltage

$V_{GT}$  — DC gate trigger voltage;  $V_D = 12\text{ V dc}$ ;  $R_L = 60\text{ }\Omega$

$V_{TM}$  — Peak on-state voltage at max rated RMS current

### General Notes

- All measurements are made with 60 Hz resistive load and at an ambient temperature of  $+25\text{ }^\circ\text{C}$  unless otherwise specified.
- Operating temperature range ( $T_J$ ) is  $-65\text{ }^\circ\text{C}$  to  $+110\text{ }^\circ\text{C}$  for TO-92 devices and  $-40\text{ }^\circ\text{C}$  to  $+110\text{ }^\circ\text{C}$  for all other devices.
- Storage temperature range ( $T_S$ ) is  $-65\text{ }^\circ\text{C}$  to  $+150\text{ }^\circ\text{C}$  for TO-92 devices,  $-40\text{ }^\circ\text{C}$  to  $+150\text{ }^\circ\text{C}$  for TO-202 devices, and  $-40\text{ }^\circ\text{C}$  to  $+125\text{ }^\circ\text{C}$  for TO-220 devices.
- Lead solder temperature is a maximum of  $230\text{ }^\circ\text{C}$  for 10 seconds maximum at a minimum of  $1/16"$  ( $1.59\text{ mm}$ ) from case.
- The case or lead temperature ( $T_C$  or  $T_L$ ) is measured as shown on dimensional outline drawings. See "Package Dimensions" section of this catalog.

$V_{TM}$	$V_{GT}$	$I_H$	$I_{GT(M)}$	$P_{GM}$	$P_{G(AV)}$	$I_{TSM}$	$dv/dt(c)$	$dv/dt$	$t_{gt}$	$I^2t$	$di/dt$
(1) (4)	(2) (5) (15)	(1) (7)	(13)	(13)		(8) (10)	(1) (10)	(1)	(9)		
Volts $T_C = 25^\circ C$	Volts $T_C = 25^\circ C$	mAmps	Amps	Watts	Watts	Amps 60/50 Hz	Volts/ $\mu$ Sec	Volts/ $\mu$ Sec $T_C = 100^\circ C$	$\mu$ Sec	Amps <sup>2</sup> Sec	Amps/ $\mu$ Sec
MAX	MAX	MAX					TYP	TYP	TYP		
1.6	2	10	1.6	18	0.4	60/50	1	40	3	15	70
1.6	2	10	1.6	18	0.4	60/50	1	30	3	15	70
1.6	2	10	1.6	18	0.4	60/50	1	20	3	15	70
1.6	2	10	1.6	18	0.4	60/50	2	40	3	15	70
1.6	2	10	1.6	18	0.4	60/50	2	30	3	15	70
1.6	2	10	1.6	18	0.4	60/50	2	20	3	15	70
1.6	2	20	1.6	18	0.4	60/50	2	45	3.2	15	70
1.6	2	20	1.6	18	0.4	60/50	2	40	3.2	15	70
1.6	2	20	1.6	18	0.4	60/50	2	30	3.2	15	70
1.6	2	10	1.6	18	0.4	80/65	2	40	3	26.5	70
1.6	2	10	1.6	18	0.4	80/65	2	30	3	26.5	70
1.6	2	10	1.6	18	0.4	80/65	2	20	3	26.5	70
1.6	2	20	1.6	18	0.4	80/65	2	45	3.2	26.5	70
1.6	2	20	1.6	18	0.4	80/65	2	40	3.2	26.5	70
1.6	2	20	1.6	18	0.4	80/65	2	30	3.2	26.5	70

### Electrical Specification Notes

- For either polarity of MT2 with reference to MT1 terminal
- For either polarity of gate voltage  $V_{GT}$  with reference to MT1 terminal
- See Gate Characteristics and Definition of Quadrants.
- See Figure E1.4 for  $i_T$  versus  $v_T$ .
- See Figure E1.6 for  $V_{GT}$  versus  $T_C$ .
- See Figure E1.7 for  $I_{GT}$  versus  $T_C$ .
- See Figure E1.5 for  $I_H$  versus  $T_C$ .
- See Figure E1.9 for surge rating and specific duration.
- See Figure E1.8 for  $t_{gt}$  versus  $I_{GT}$ .
- See Figure E1.2 and Figure E1.3 for maximum allowable case temperature at maximum rated current.
- See Figure E1.1, Figure E1.2, and Figure E1.3 for  $T_A$  or  $T_C$  versus  $I_{T(RMS)}$ .
- See package outlines for lead form configurations. When ordering special lead forming, add type number as suffix to part number.
- Pulse width  $\leq 10 \mu s$
- $T_C$  or  $T_L = T_J$  for test conditions in off state
- Minimum non-trigger  $V_{GT}$  at  $110^\circ C$  is 0.2 V.

### Gate Characteristics

Teccor triacs may be turned on between gate and MT1 terminals in the following ways:

- In-phase signals (with standard AC line) using Quadrants I and III
- Application of unipolar pulses (gate always positive or negative), using Quadrants II and III with negative gate pulses and Quadrants I and IV with positive gate pulses

When maximum surge capability is required, pulses should be a minimum of one magnitude above  $I_{GT}$  rating with a steep rising waveform ( $\leq 1 \mu s$  rise time).

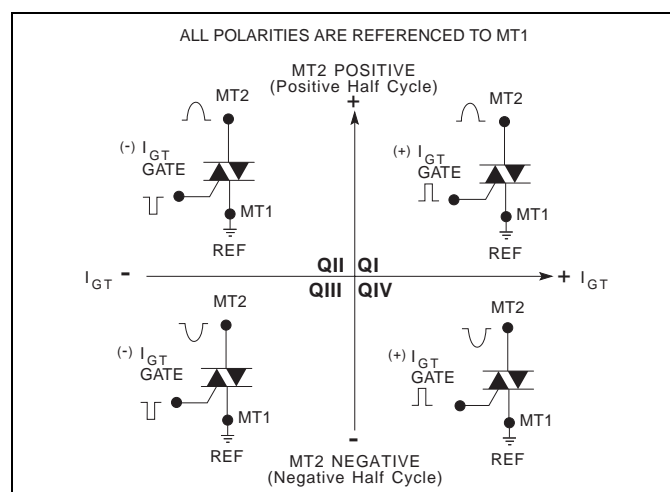



Definition of Quadrants

## Electrical Isolation

Teccor's isolated triac packages withstand a minimum high potential test of 2500 V ac rms from leads to mounting tab over the device's operating temperature range. The following isolation table shows standard isolation ratings.

Electrical Isolation from Leads to Mounting Tab	
V AC RMS	TO-220 *
2500	Standard

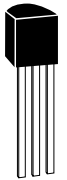
\*UL Recognized File #E71639

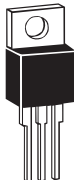
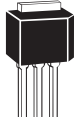
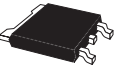
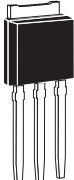
Thermal Resistance (Steady State) Junction to Mounting Tab and Junction to Ambient $R_{\theta JC}$ [ $R_{\theta JA}$ ] °C/W (TYP)							
Package Code	E	C	F	L	F2	D	V
Type	 TO-92 Plastic	 Compak	 TO-202 Type 1	 TO-220 Isolated	 TO-202 Type 2	 TO-252 D-Pak	 TO-251 V-Pak
0.8 A	60 [135]	60 *					
1 A	50 [95]	40 *					
4 A			3.5 [45]	3.6 [50]	6.0 [70]	3.5	6.0 [70]
6 A				3.3		3.2	3.2
8 A				2.8		2.7	2.7

\* Mounted on 1 cm<sup>2</sup> copper foil surface; two-ounce copper foil

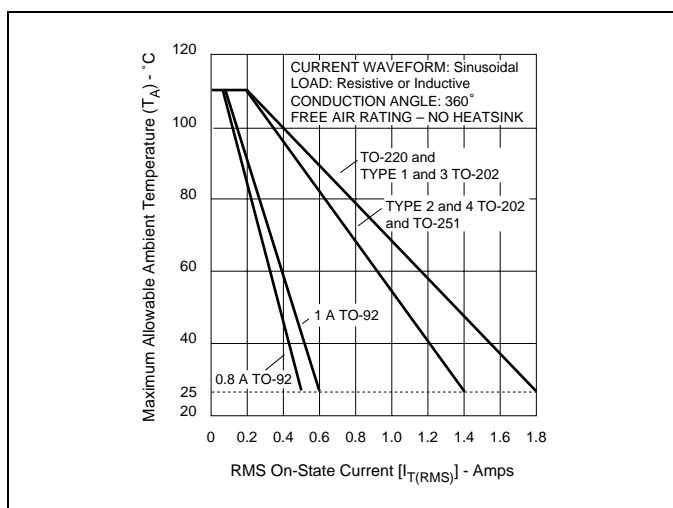

Figure E1.1 Maximum Allowable Ambient Temperature versus On-state Current

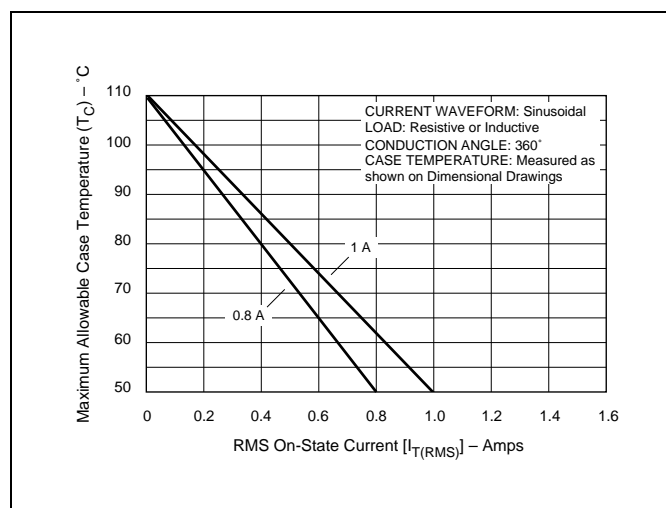

Figure E1.2 Maximum Allowable Case Temperature versus On-state Current (0.8 A and 1 A)

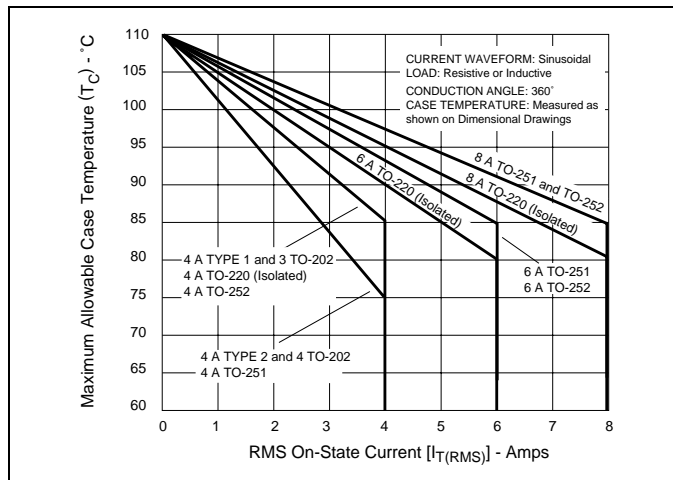

Figure E1.3 Maximum Allowable Case Temperature versus On-state Current (4 A, 6 A, and 8 A)

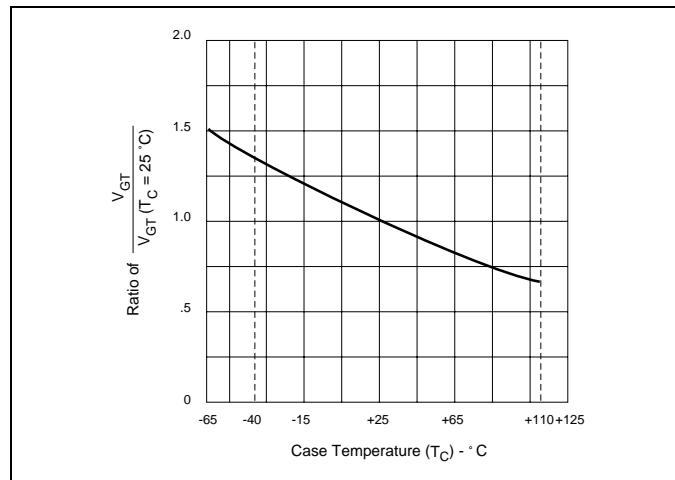

Figure E1.6 Normalized DC Gate Trigger Voltage for All Quadrants versus Case Temperature

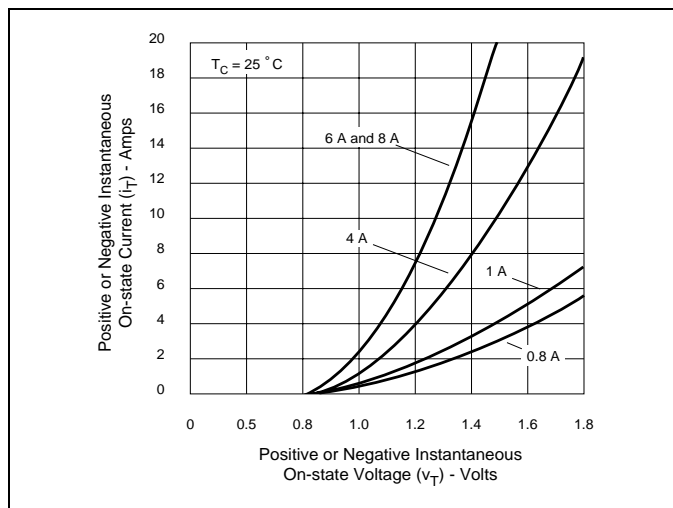

Figure E1.4 On-state Current versus On-state Voltage (Typical)

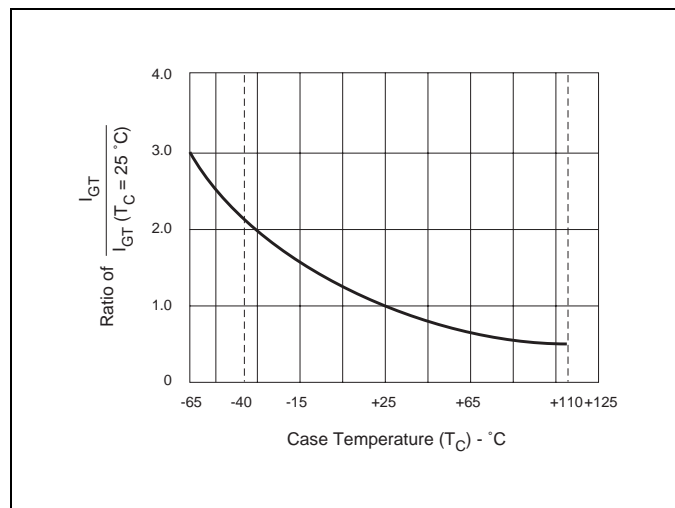

Figure E1.7 Normalized DC Gate Trigger Current for All Quadrants versus Case Temperature

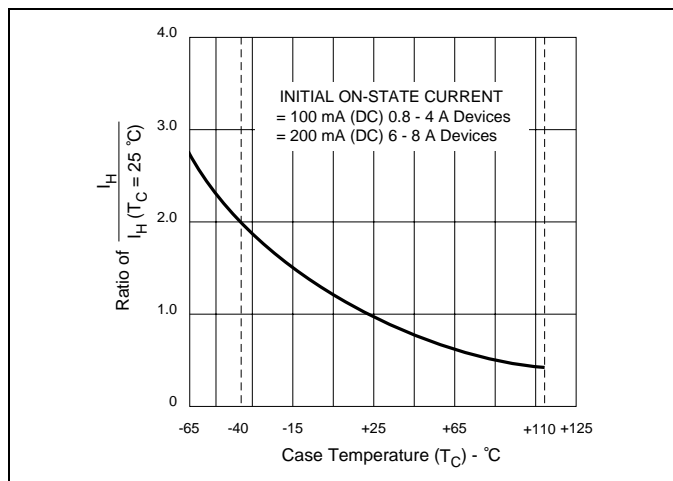

Figure E1.5 Normalized DC Holding Current versus Case Temperature

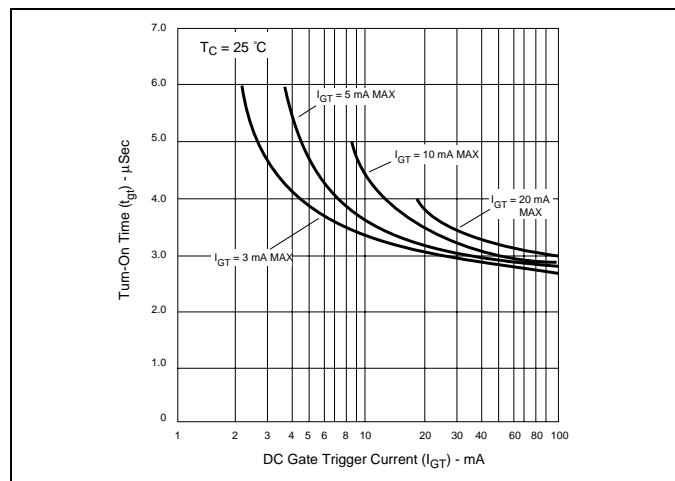

Figure E1.8 Turn-on Time versus Gate Trigger Current (Typical)

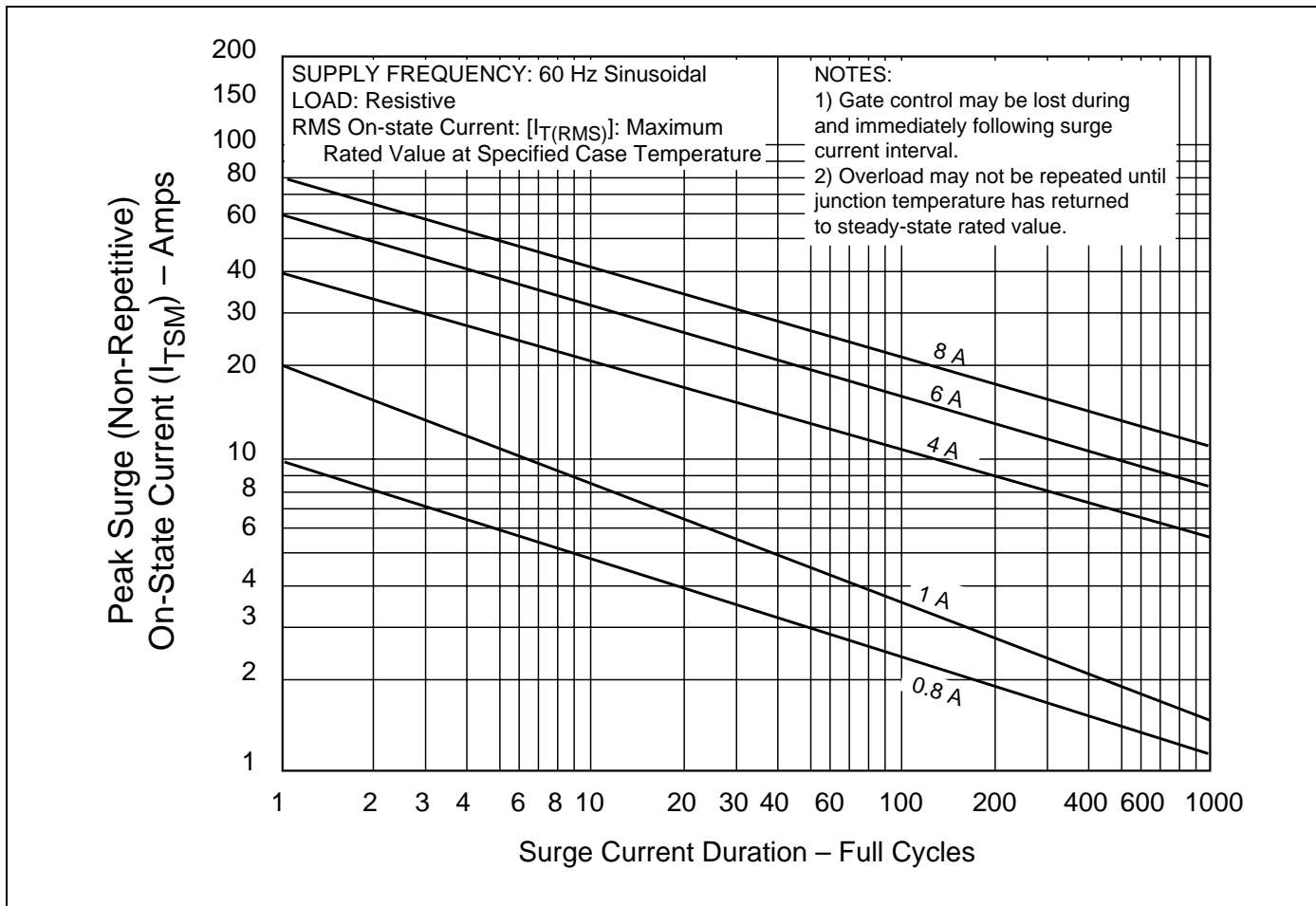

Figure E1.9 Peak Surge Current versus Surge Current Duration

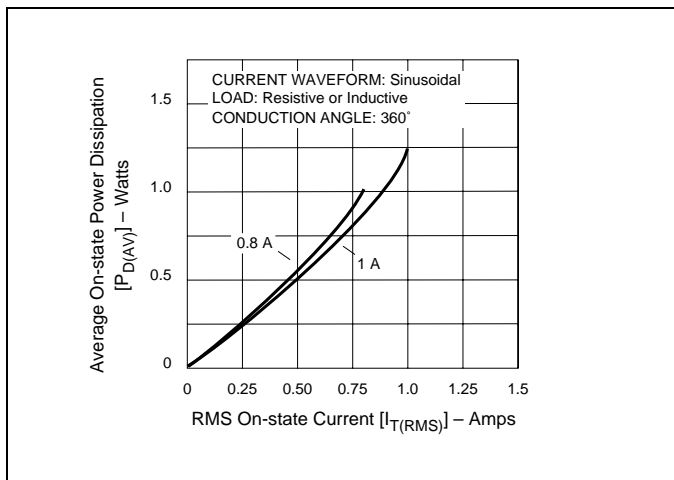

Figure E1.10 Power Dissipation (Typical) versus RMS On-state Current (0.8 A and 1 A)

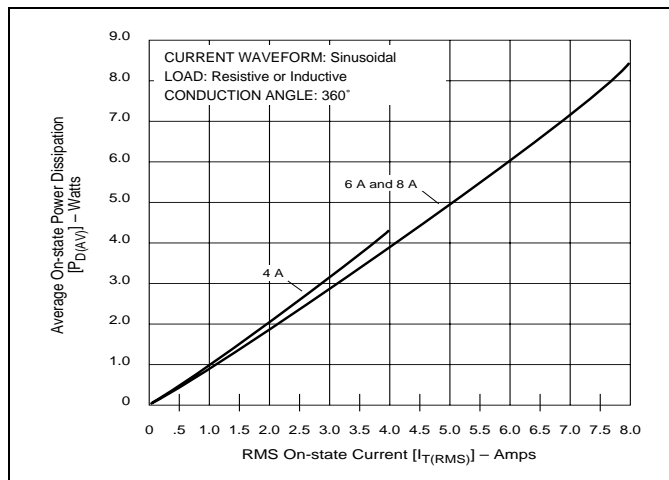

Figure E1.11 Power Dissipation (Typical) versus RMS On-state Current (4 A, 6 A, and 8 A)