

Micro Monitor Supply Control

KK1705

The KK1705 is designed to control power supply and to start microcontroller and microprocessor systems. It is used for securing stable functioning of the system when starting and halting the device as well as in the case of the supply voltage drops.

Manufactured in 8-pin SOIC/DIP package MS-012AA.

LSI features:

- rated supply voltage 5.0 V;
- generation of reset signal when power supply is on for correct start of microprocessor;
- generation of reset signal when power supply drops below the operating one to avoid incorrect functioning of microprocessor;
- generation of reset signal when pushing reset button;
- possibility to program threshold voltage at which reset is generated.

The IN1705 contains a source of reference voltage, two analog comparators, watchdog timer, digital sampler, digital delay..

Functions:

- generation of reset signal per fixed level of supply voltage;
- generation of reset signal from external "Reset" button;
- generation of signal of watchdog timer status;
- emergency interruption of primary power source.

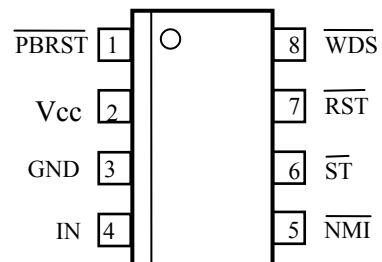
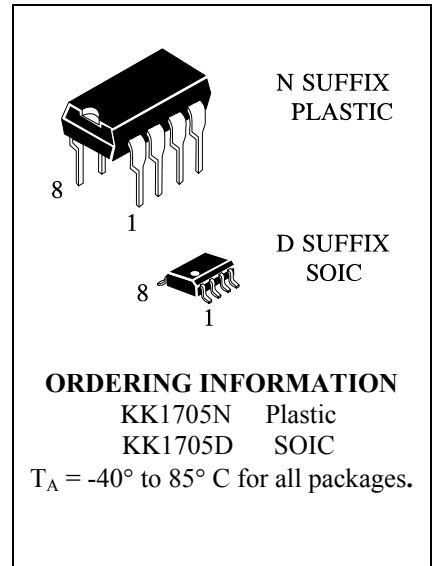

Fig. 2 – Pin assignment

Industrial temperature range

Industrial temperature range - 40°C to + 85°C.

Table 1 – Recommended operating conditions

Symbol	Parameter	Typical		Units
		min	max	
V _{CC}	Supply voltage	1.2	5.5	V
V _{IH}	Input voltage, high level	2.0	V _{CC} +0.3	V
V _{IL}	Input voltage, low level	-0.03	0.5	V
T _A	Operating temperature range	-40	85	°C

Table 2 – Absolute maximum ratings

Symbol	Parameter	Typical		Units
		min	max	
V _{CC}	Supply voltage	-0.5	7.0	V
V _{IH}	Input voltage, high level	-	V _{CC} +0.5	V
V _{IL}	Input voltage, low level	-0.5	-	V
T _{stg}	Storage temperature	-60	125	°C

Exposure to absolute maximum rating conditions may affect reliability of IC and its functional operation. Upon removing the absolute maximum ratings conditions, functional operation is guaranteed in recommended operating conditions.

Table 3 – DC electrical characteristics ($T_A = -40^\circ$ to $+85^\circ\text{C}$)

Symbol	Parameter	Test conditions	Typical		Units
			min	max	
V_{IL}	Input voltage, low level	V_{CC} =from 2.4 to 5.5V	-	0.5	V
V_{IH}	Input voltage, high level	V_{CC} =from 2.4 to 5.5V	2.0		V
$7I_{OL}$	Output current, low level (NMI, RST)	V_{CC} =from 2.4 to 5.5V $V_{OL}=0.4\text{V}$	10.0	-	mA
I_{OH}	Output current, high level (WDS, NMI)	V_{CC} =from 4.5 to 5.5V $V_{OH}=2.4\text{V}$	-100	-1000	μA
I_{OH1}	Output current, high level, (RST)	V_{CC} =from 5.0 to 5.5V $V_{OH}=2.4\text{V}$	-10	-	mA
V_{OH}	Output voltage, high level (RST)	V_{CC} =from 5.0 to 5.5V $I_{OH}=-500\text{mA}$	$V_{CC}-0.3$	-	V
I_{LIL1}	Input leakage current, low level (IN)	V_{CC} =from 1.2 to 5.5V $V_{IL}=0\text{V}$	-	-1.0	μA
I_{LIL2}	Input leakage current, low level (ST)	$V_{CC}=5.5\text{V}$ $V_{IL}=0\text{V}$	-10	-100	μA
I_{LIL3}	Input leakage current, low level (PBRST)	$V_{CC}=5.5\text{V}$ $V_{IL}=0\text{V}$	-50	-450	μA
I_{LIH}	Input leakage current, high level	V_{CC} =from 1.2 to 5.5V $V_{IH}=V_{CC}$	-	1.0	μA
I_{CC}	Operating current	V_{CC} =from 1.2 to 5.5V $V_{IL}=0\text{V}, V_{IH}=V_{CC}$	-	60	μA
V_{CCTP}	V_{CC} trip point	$V_{IL}=0\text{V}, V_{IH}=V_{CC}$	4.5	4.75	V
V_{TP}	IN input trip point	$V_{CC}=5.0\text{V}$ $V_{IL}=0\text{V}, V_{IH}=V_{CC}$	1.2	1.3	V

Table 4 – AC electrical characteristics ($V_{CC} = 5.0\text{ B}$, $T_A = -40^\circ$ to $+85^\circ\text{C}$)

Symbol	Parameter	Typical		Units
		min	max	
t_{TD}	Watchdog timeout	1.0	2.2	s
t_{PDLY}	$\overline{\text{PBRST}}$ stable low to $\overline{\text{RST}}$ and $\overline{\text{RST}}$	-	250	ns
t_{RST}	Reset active time	130	285	ms
t_{RPD}	V_{CC} detect to $\overline{\text{RST}}$ and $\overline{\text{RST}}$	-	8.0	μs
t_{RPU}	V_{CC} detect to $\overline{\text{RST}}$ and $\overline{\text{RST}}$	130	285	ms
t_{IPD}	V_{IN} detect to NMI	-	8.0	μs
t_{PB}	$\overline{\text{PBRST}} = V_{IL}$	150	-	ns
t_{ST}	$\overline{\text{ST}}$ Pulse Width	10	-	ns

Timing diagrams

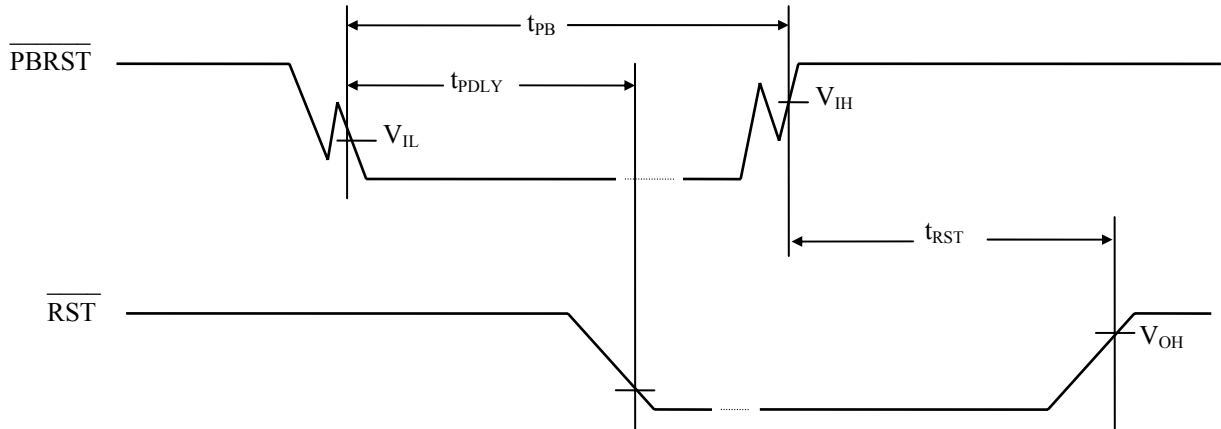

Fig. 3 – Timing diagram of forming reset signal from external PBRST control button

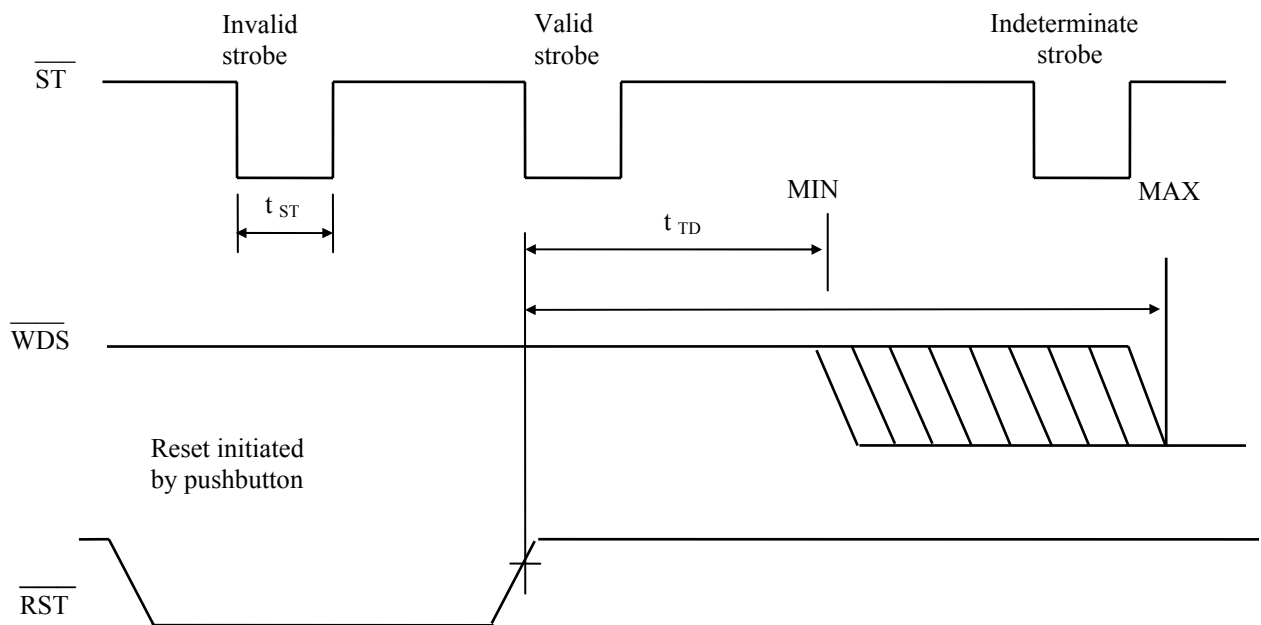

Fig. 4 – Timing diagram: strobe input

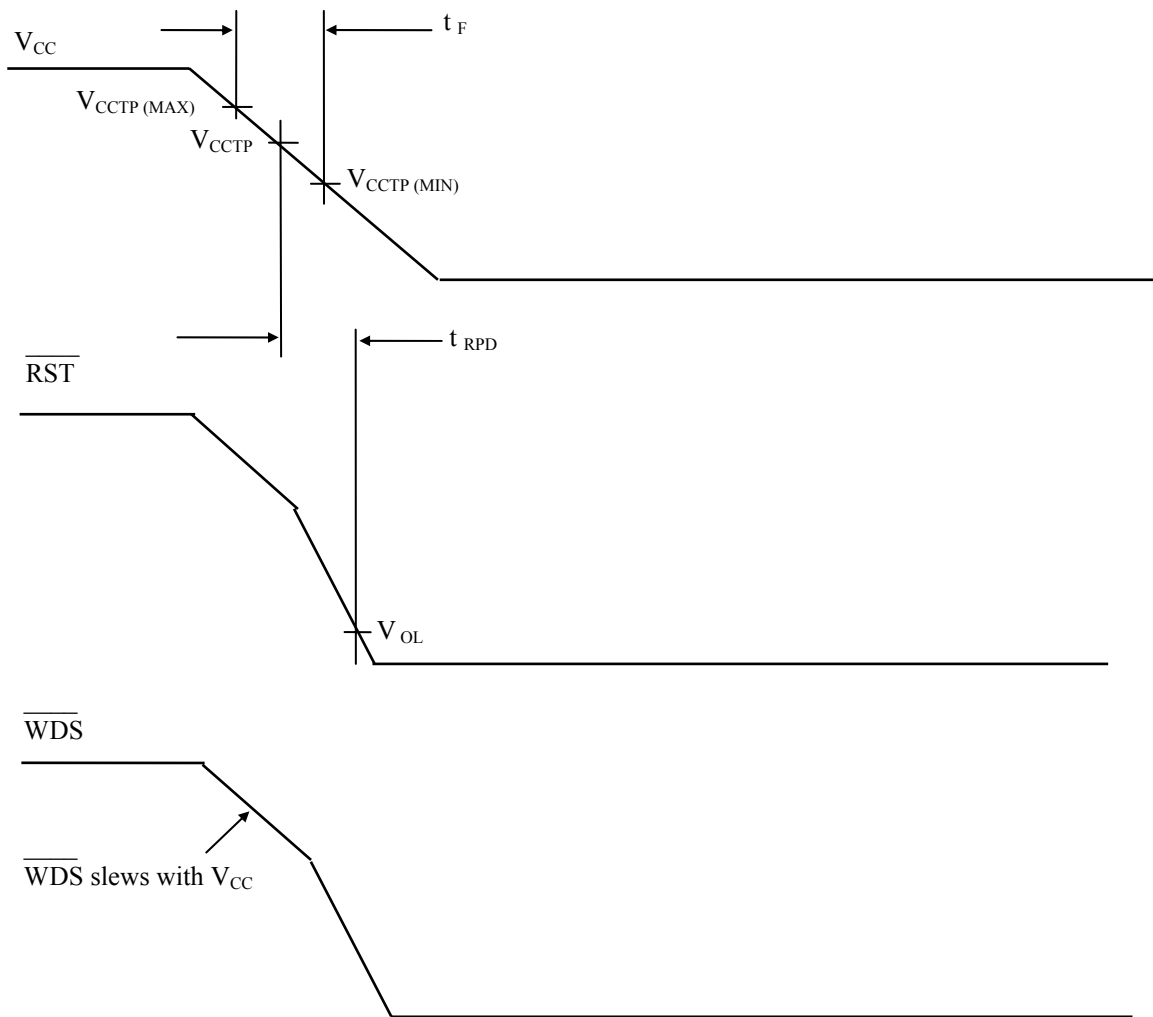

Fig. 5 – Timing diagram: power down to V_{CCTP}

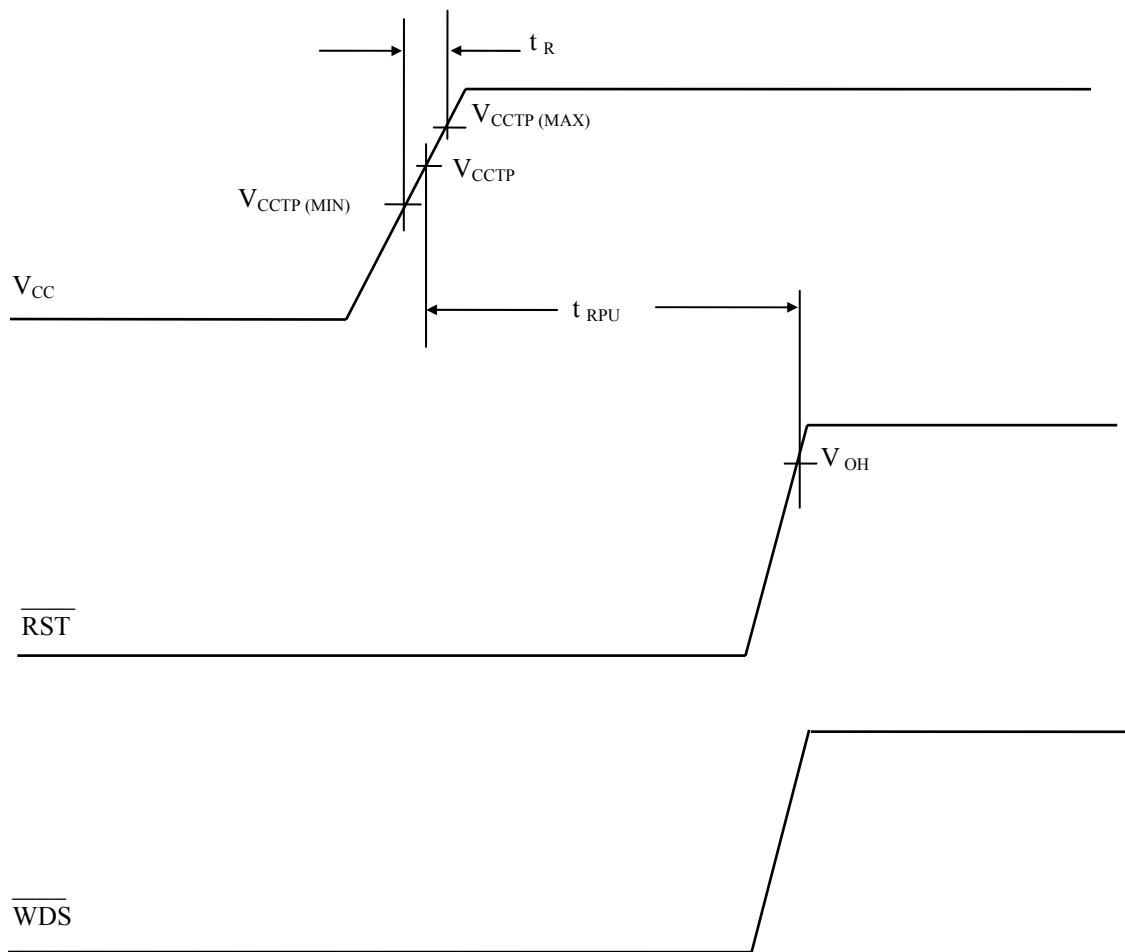

Fig. 6 – Timing diagram: Power-Up

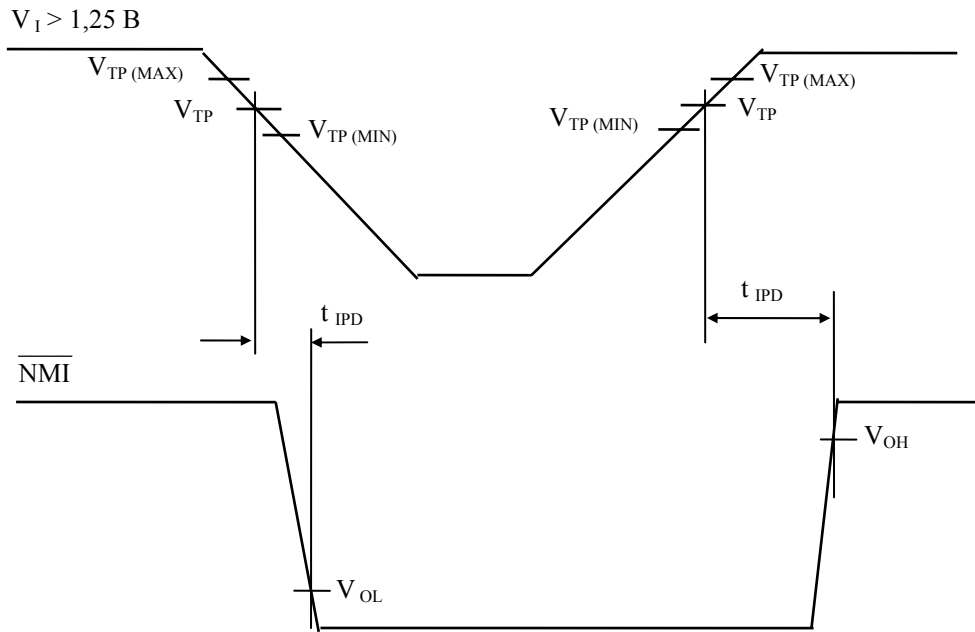

Fig. 7 – Timing diagram: Non-Maskable Interrupt

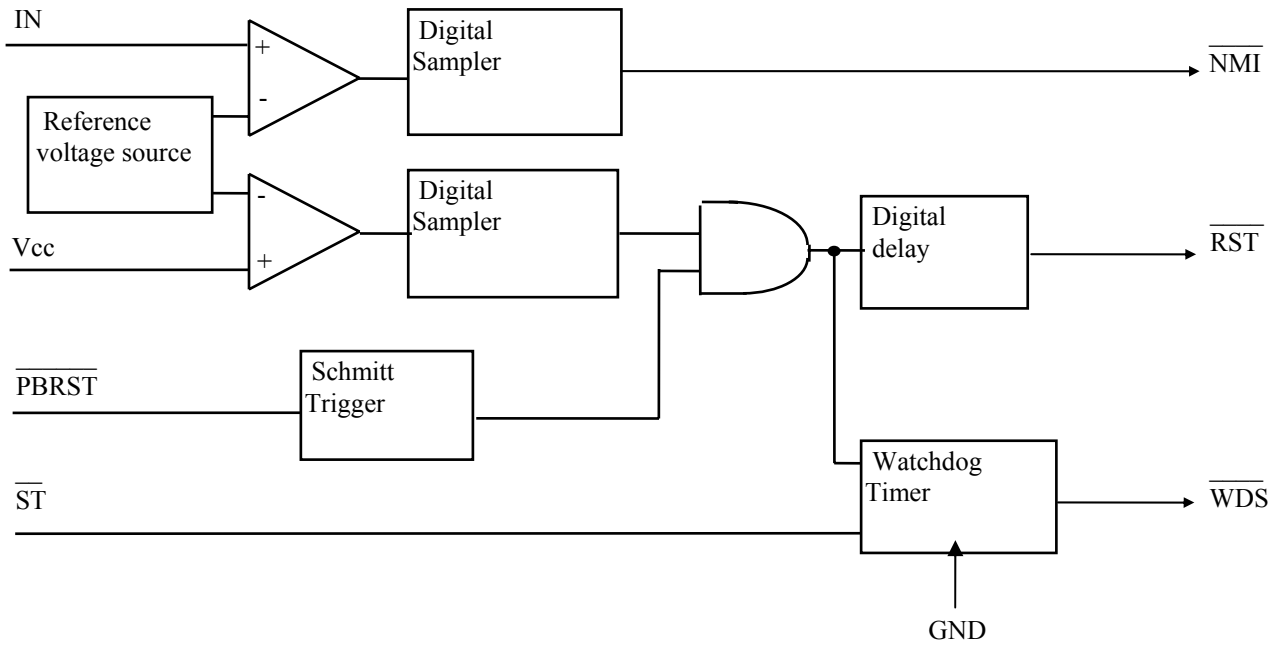
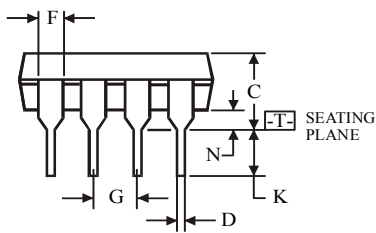
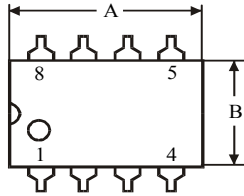
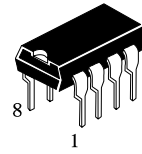

Fig. 8 – Block Diagram

Table 5 – Pin description

Pin	Symbol	Description	Type
01	PBRST	Pushbutton reset input	Input
02	Vcc	Power supply	-
03	GND	Ground	-
04	IN	Input	Input
05	NMI	Non-maskable interrupt	Output
06	ST	Watchdog timer strobe	Input
07	RST	Active low reset	Output
08	WDS	Watchdog status	Output

N SUFFIX PLASTIC DIP (MS - 001BA)



$\oplus 0.25 (0.010) \text{ (M) T}$

Symbol	Dimension, mm	
	MIN	MAX
A	8.51	10.16
B	6.1	7.11
C		5.33
D	0.36	0.56
F	1.14	1.78
G	2.54	
H	7.62	
J	0°	10°
K	2.92	3.81
L	7.62	8.26
M	0.2	0.36
N	0.38	

NOTES:

- Dimensions "A", "B" do not include mold flash or protrusions.
Maximum mold flash or protrusions 0.25 mm (0.010) per side.

D SUFFIX SOIC (MS - 012AA)

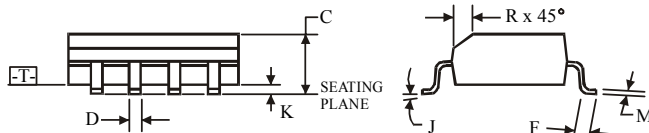
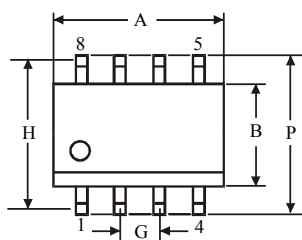
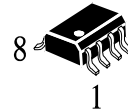

$\oplus 0.25 (0.010) \text{ (M) T (C) (M)}$

Symbol	Dimension, mm	
	MIN	MAX
A	4.8	5
B	3.8	4
C	1.35	1.75
D	0.33	0.51
F	0.4	1.27
G	1.27	
H	5.72	
J	0°	8°
K	0.1	0.25
M	0.19	0.25
P	5.8	6.2
R	0.25	0.5

NOTES:

- Dimensions A and B do not include mold flash or protrusion.
- Maximum mold flash or protrusion 0.15 mm (0.006) per side for A; for B - 0.25 mm (0.010) per side.