

RF MOSFET Power Transistor, 15W, 12V

2 - 175 MHz

DU1215S

V2.00

Features

- N-Channel Enhancement Mode Device
- DMOS Structure
- Lower Capacitances for Broadband Operation
- High Saturated Output Power
- Lower Noise Figure Than Bipolar Devices
- Specifically Designed for 12 Volt Applications

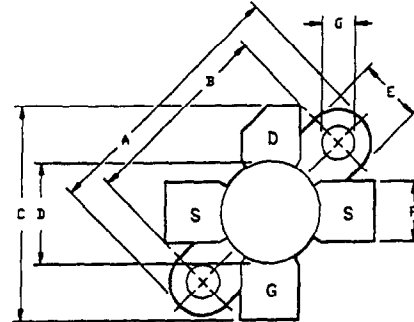

Absolute Maximum Ratings at 25°C

Parameter	Symbol	Rating	Units
Drain-Source Voltage	V_{DS}	40	V
Gate-Source Voltage	V_{GS}	20	V
Drain-Source Current	I_{DS}	4	A
Power Dissipation	P_D	87.5	W
Junction Temperature	T_J	200	°C
Storage Temperature	T_{STG}	-55 to +150	°C
Thermal Resistance	θ_{JC}	2	°C/W

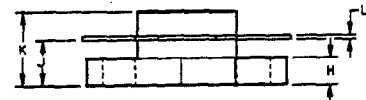

LETTER DIM	MILLIMETERS		INCHES	
	MIN	MAX	MIN	MAX
A	24.64	24.89	.970	.980
B	18.29	18.54	.720	.730
C	20.07	20.83	.790	.820
D	9.47	9.73	.373	.383
E	6.22	6.48	.245	.255
F	5.64	5.79	.222	.228
G	2.92	3.30	.115	.130
H	2.29	2.67	.090	.105
J	4.04	4.55	.159	.179
K	6.58	7.39	.259	.291
L	.10	.15	.004	.006

Electrical Characteristics at 25°C

Parameter	Symbol	Min	Max	Units	Test Conditions
Drain-Source Breakdown Voltage	BV_{DSS}	40	-	V	$V_{GS}=0.0\text{ V}, I_{DS}=5.0\text{ mA}$
Drain-Source Leakage Current	I_{DSS}	-	1.0	mA	$V_{DS}=15.0\text{ V}, V_{GS}=0.0\text{ V}$
Gate-Source Leakage Current	I_{GSS}	-	1.0	μA	$V_{GS}=20.0\text{ V}, V_{DS}=0.0\text{ V}$
Gate Threshold Voltage	$V_{GS(TH)}$	2.0	6.0	V	$V_{DS}=10.0\text{ V}, I_{DS}=100\text{ mA}$
Forward Transconductance	G_M	0.5	-	S	$V_{DS}=10.0\text{ V}, I_{DS}=1000\text{ mA}, \Delta V_{GS}=1.0\text{ V}$
Input Capacitance	C_{ISS}	-	50	pF	$V_{DS}=12.0\text{ V}, F=1.0\text{ MHz}$
Output Capacitance	C_{OSS}	-	60	pF	$V_{DS}=12.0\text{ V}, F=1.0\text{ MHz}$
Reverse Capacitance	C_{RSS}	-	12	pF	$V_{DS}=12.0\text{ V}, F=1.0\text{ MHz}$
Power Gain	G_P	9.5	-	dB	$V_{DD}=12.0\text{ V}, I_{DQ}=100\text{ mA}, P_{OUT}=15\text{ W}, F=175\text{ MHz}$
Drain Efficiency	η_D	60	-	%	$V_{DD}=12.0\text{ V}, I_{DQ}=100\text{ mA}, P_{OUT}=15\text{ W}, F=175\text{ MHz}$
Load Mismatch Tolerance	VSWR-T	-	30:1	-	$V_{DD}=12.0\text{ V}, I_{DQ}=100\text{ mA}, P_{OUT}=15\text{ W}, F=175\text{ MHz}$

Specifications Subject to Change Without Notice.

MA-COM, Inc.

North America: Tel. (800) 366-2266
Fax (800) 618-8883

■ Asia/Pacific: Tel. +81 (03) 3226-1671
Fax +81 (03) 3226-1451

■ Europe: Tel. +44 (1344) 869 595
Fax +44 (1344) 300 020

Typical Device Impedance

Frequency (MHz)	Z _{IN} (OHMS)	Z _{LOAD} (OHMS)
30	3.0 - j 25	4.0 - j 3.0
100	3.0 - j 15	3.5 - j 1.5
175	5.0 - j 8	4.0 + j 0.0

V_{DD}=12 V, I_{DQ}=100 mA, P_{OUT}=15 Watts

Z_{IN} is the series equivalent input impedance of the device from gate to source.

Z_{LOAD} is the optimum series equivalent load impedance as measured from drain to ground.

RF Test Fixture

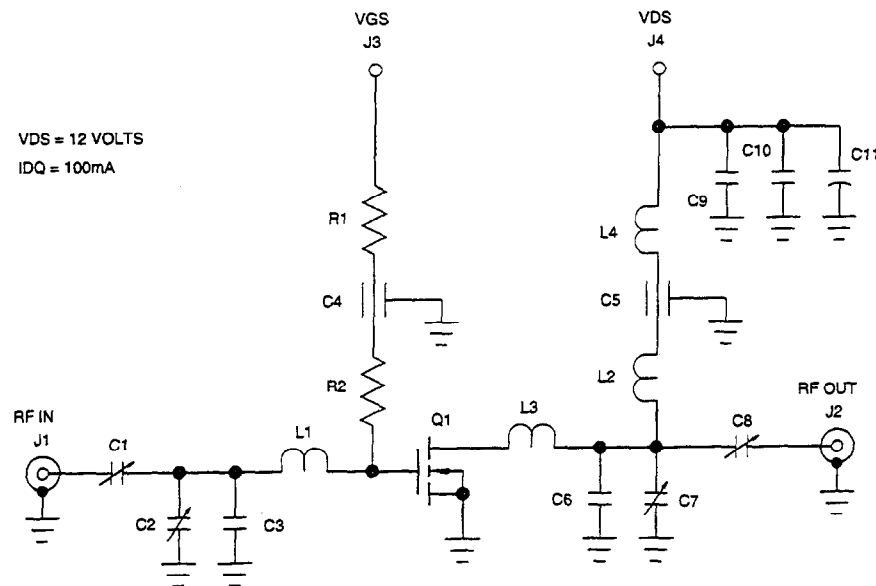

VDS = 12 VOLTS
IDQ = 100mA

PARTS LIST

C1,C8	TRIMMER CAPACITOR 5-80pF
C2,C7	TRIMMER CAPACITOR 4-40pF
C3,C6	SEMCO CAPACITOR 30pF
C4,C5	FEEDTHROUGH CAPACITOR 0.001uF
C9	SEMCO CAPACITOR 1000pF
C10	MONOLITHIC CERAMIC CAPACITOR 0.01uF
C11	ELECTROLYTIC CAPACITOR 50uF 50 V.
L1,L3	NO. 12 AWG COPPER WIRE X 1"
L2	8 TURNS OF NO. 20 AWG ENAMEL WIRE ON "0.25", CLOSE WOUND
L4	12 TURNS OF NO. 20 AWG ON "0.25", CLOSE WOUND
R1,R2	RESISTOR 100K OHMS
Q1	DU1215S
BOARD	FR4 0.062"

Specifications Subject to Change Without Notice.

M/A-COM, Inc.

North America: Tel. (800) 366-2266
Fax (800) 618-8883

Asia/Pacific: Tel. +81 (03) 3226-1671
Fax +81 (03) 3226-1451

Europe: Tel. +44 (1344) 869 595
Fax +44 (1344) 300 020

Typical Broadband Performance Curves

EFFICIENCY vs FREQUENCY

$V_{DD}=12\text{ V}$ $I_{DQ}=100\text{ mA}$ $P_{OUT}=15\text{ W}$

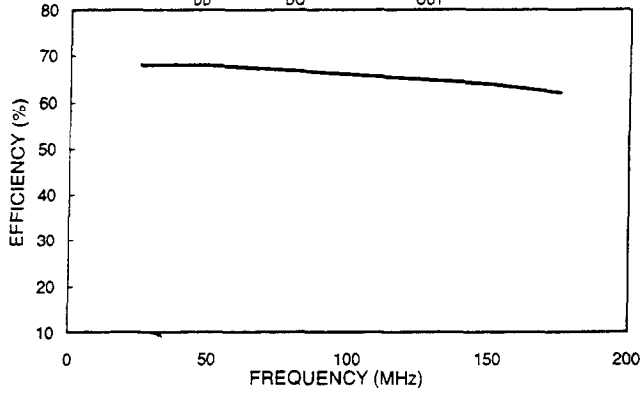

GAIN vs FREQUENCY

$V_{DD}=12\text{ V}$ $I_{DQ}=100\text{ mA}$ $P_{OUT}=15\text{ W}$

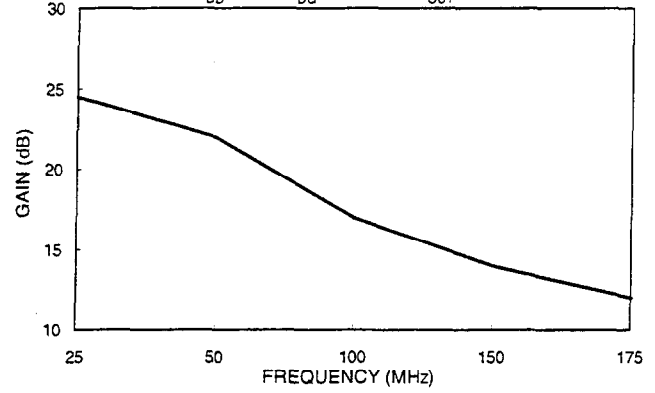

POWER OUTPUT vs POWER INPUT

$V_{DD}=12\text{ V}$ $I_{DQ}=100\text{ mA}$

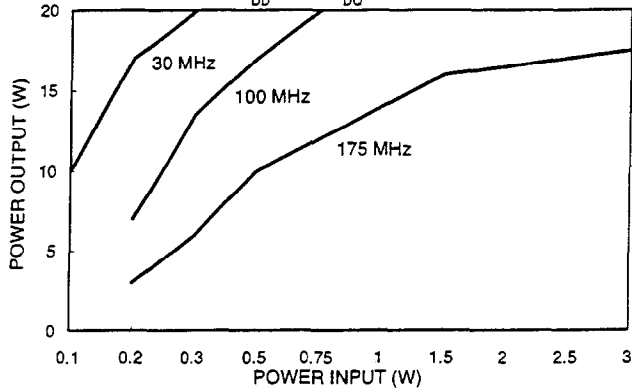

POWER OUTPUT vs SUPPLY VOLTAGE

$V_{DD}=12\text{ V}$ $F=175\text{ MHz}$ $P_{IN}=1.0\text{ W}$

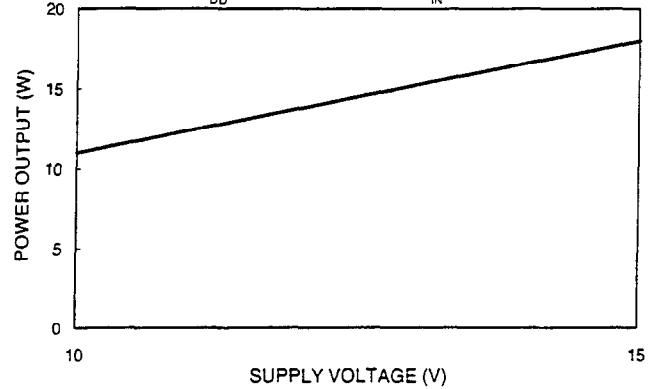

Specifications Subject to Change Without Notice.

MA-COM, Inc.

North America: Tel. (800) 366-2266
Fax (800) 618-8883

Asia/Pacific: Tel. +81 (03) 3226-1671
Fax +81 (03) 3226-1451

Europe: Tel. +44 (1344) 869 595
Fax +44 (1344) 300 020