

CD4030A Types

CMOS Quad Exclusive-OR Gate

The RCA-CD4030A types consist of four independent Exclusive-OR gates integrated on a single monolithic silicon chip. Each Exclusive-OR gate consists of four n-channel and four p-channel enhancement-type transistors. All inputs and outputs are protected against electrostatic effects.

These types are supplied in 14-lead hermetic dual-in-line ceramic packages (D and F suffixes), 14-lead dual-in-line plastic package (E suffix), 14-lead ceramic flat package (K suffix), and in chip form (H suffix).

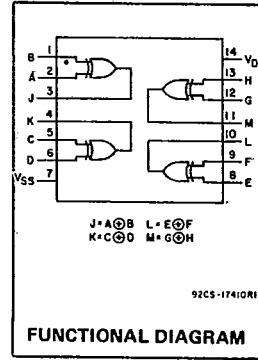

MAXIMUM RATINGS, Absolute-Maximum Values

STORAGE TEMPERATURE RANGE (T_{stg})	-65 to +150°C
OPERATING TEMPERATURE RANGE (T_A)	
PACKAGE TYPES D, F, K, H	-55 to +125°C
PACKAGE TYPE E	-40 to +85°C
DC SUPPLY VOLTAGE RANGE (V_{DD})	
(Voltages referenced to V_{SS} Terminal)	-0.5 to +15V
POWER DISSIPATION PER PACKAGE (P_D)	
FOR $T_A = -40$ to +60°C (PACKAGE TYPE E)	500 mW
FOR $T_A = +60$ to +85°C (PACKAGE TYPE E)	Derate Linearly at 12 mW/°C to 200 mW
FOR $T_A = -55$ to +100°C (PACKAGE TYPES D, F, K)	500 mW
FOR $T_A = +100$ to +125°C (PACKAGE TYPES D, F, K)	Derate Linearly at 12 mW/°C to 200 mW
DEVICE DISSIPATION PER OUTPUT TRANSISTOR	
FOR $T_A =$ FULL PACKAGE TEMPERATURE RANGE (ALL PACKAGE TYPES)	100 mW
INPUT VOLTAGE RANGE, ALL INPUTS	-0.5 to $V_{DD} + 0.5$
LEAD TEMPERATURE (DURING SOLDERING)	
At distance 1/16 ± 1/32 Inch (159 ± 0.79 mm) from case for 10s max.	+265°C

RECOMMENDED OPERATING CONDITIONS at $T_A = 25^\circ\text{C}$,

For maximum reliability, nominal operating conditions should be selected so that operation is always within the following ranges:

CHARACTERISTIC	LIMITS				UNITS
	D, F, K, H Packages		E Package		
	Min.	Max.	Min.	Max.	
Supply Voltage Range (For $T_A =$ Full Package Temperature Range)	3	12	3	12	V

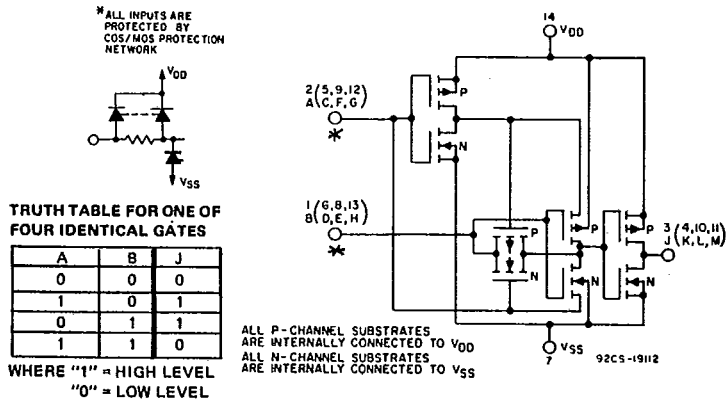

Features:

- Medium speed operation.
- . . . $t_{PHL} = t_{PLH} = 40$ ns (typ.) @ $C_L = 15$ pF and $V_{DD} - V_{SS} = 10$ V
- Low output impedance.
- . . . 500Ω (typ.) @ $V_{DD} - V_{SS} = 10$ V
- Quiescent current specified to 15 V
- Maximum input leakage current of 1 μA at 15 V (Full package-temperature range)
- 1-V noise margin (full package-temperature range)

Applications:

- Even and odd-parity generators and checkers
- Logical comparators
- Adders/subtractors
- General logic functions

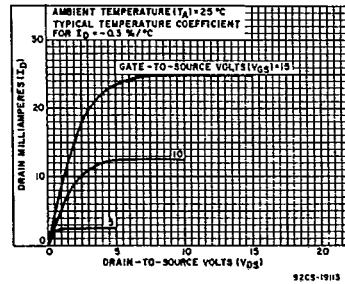

Fig. 2 - Typical output n-channel drain characteristics.

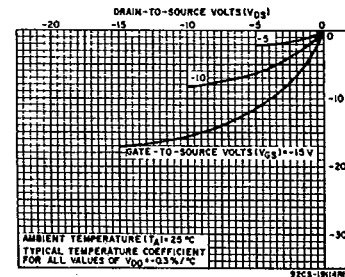

Fig. 3 - Typical output p-channel drain characteristics.

For quiescent device current, noise immunity, and input leakage current test circuits see "Rating and Characteristics" at the beginning of the CMOS section.

CD4030A Types

STATIC ELECTRICAL CHARACTERISTICS

Characteristic	Conditions			Limits at Indicated Temperatures (°C)								Units
				D, F, K, H Packages				E Package				
	V _O (V)	V _{IN} (V)	V _{DD} (V)	-55	+25		+125	-40	+25		+85	
Quiescent Device Current I _L Max.	-	-	5	0.5	0.005	0.5	30	5	0.05	5	70	μA
	-	-	10	1	0.01	1	60	10	0.1	10	140	
	-	-	15	25	0.5	25	1000	250	2.5	250	2500	
Output Voltage: Low Level, V _{OL}	-	5	5	0 Typ.; 0.05 Max.								V
	-	10	10	0 Typ.; 0.05 Max.								
	-	0	5	4.95 Min.; 5 Typ.								
High Level V _{OH}	-	0	5	9.95 Min.; 10 Typ.								V
	-	0	10									
Noise Immunity: Inputs Low, V _{NL}	3.6	-	5	1.5 Min.; 2.25 Typ.								V
	7.2	-	10	3 Min.; 4.5 Typ.								
	1.4	-	5	1.5 Min.; 2.25 Typ.								
Inputs High V _{NH}	2.8	-	10	3 Min.; 4.5 Typ.								V
Noise Margin: Inputs Low, V _{NML}	4.5	-	5	1 Min.								V
	9	-	10	1 Min.								
	0.5	-	5	1 Min.								
Inputs High, V _{NMH}	1	-	10	1 Min.								V
Output Drive Current: N Channel (Sink) I _{DN} Min.	0.5	-	5	0.75	1.2	0.6	0.45	0.35	1.2	0.3	0.25	mA
	0.5	-	10	1.5	2.4	1.2	0.9	0.7	2.4	0.6	0.5	
	4.5	-	5	-0.45	-0.6	-0.3	-0.21	-0.21	-0.6	-0.15	-0.12	
P Channel (Source): I _{DP} Min.	9.5	-	10	-0.95	-1.3	-0.65	-0.45	-0.45	-1.3	-0.32	-0.25	mA
Input Leakage Current I _L , I _{IH}	Any Input			± 10 ⁻⁵ Typ., ± 1 Max.								μA
	-	-	15									

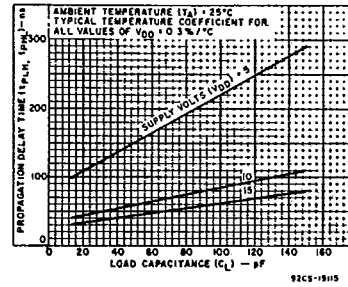

Fig. 4 - Typical propagation delay time vs. load capacitance.

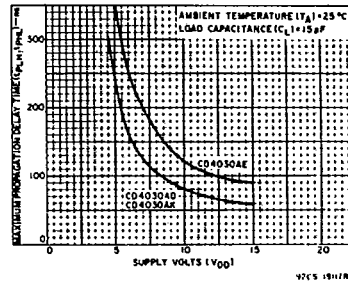

Fig. 5 - Maximum propagation delay time vs. supply voltage.

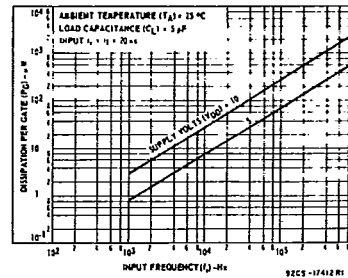

Fig. 6 - Typical dynamic power dissipation characteristics.

DYNAMIC ELECTRICAL CHARACTERISTICS at T_A = 25°C, Input t_r, t_f = 20 ns, C_L = 15 pF, R_L = 200 kΩ

Characteristic	Test Conditions	LIMITS						Units	
		D, F, K, H Packages			E Package				
		V _{DD} (V)	Min.	Typ.	Max.	Min.	Typ.		Max.
Propagation Delay Time; t _{PLH} , t _{PHL}		5	-	100	200	-	100	300	ns
		10	-	40	100	-	40	150	
Transition Time: High-to-Low Level, t _{rHL}		5	-	70	150	-	70	300	ns
		10	-	25	75	-	25	150	
Low-to-High Level, t _{rLH}		5	-	80	150	-	80	300	ns
		10	-	30	75	-	30	150	
Average Input Capacitance, C _i	Any Input	-	5	-	-	5	-	pF	

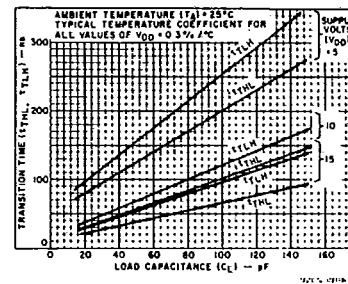
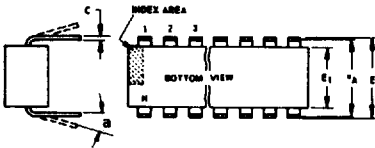
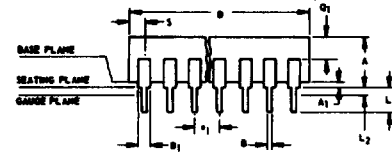

Fig. 7 - Typical transition time vs. load capacitance.

Dimensional Outlines

Dual-In-Line Welded-Seal Ceramic Packages



NOTES:

Refer to Rules for Dimensioning (JEDEC Publication No. 95) for Axial Lead Product Outlines.

- When this device is supplied solder-dipped, the maximum lead thickness (narrow portion) will not exceed 0.013" (0.33 mm).
- Leads within 0.005" (0.12 mm) radius of True Position (TP) at gauge plane with maximum material condition and unit installed.
- e_A applies in zone L_2 when unit installed.
- a applies to spread leads prior to installation.
- N is the maximum quantity of lead positions.
- N_1 is the quantity of allowable missing leads.

(D) SUFFIX (JEDEC MO-001-AD)
14-Lead Dual-In-Line Welded-Seal Ceramic Package

SYMBOL	INCHES		NOTE	MILLIMETERS	
	MIN.	MAX.		MIN.	MAX.
A	0.120	0.160		3.05	4.06
A ₁	0.020	0.065		0.51	1.65
B	0.014	0.020		0.356	0.508
B ₁	0.060	0.065		1.27	1.65
C	0.008	0.012	1	0.204	0.304
D	0.745	0.770		18.93	19.55
E	0.300	0.325		7.62	8.25
E ₁	0.240	0.260		6.10	6.60
e ₁	0.100 TP		2	2.54 TP	
e _A	0.300 TP		2, 3	7.62 TP	
L	0.125	0.150		3.18	3.81
L ₂	0.000	0.030		0.000	0.76
a	0°	15°	4	0°	15°
N	14		5	14	
N ₁	0		6	0	
Q ₁	0.050	0.085		1.27	2.15
S	0.065	0.090		1.66	2.28

92SS-4411R2

(D) SUFFIX (JEDEC MO-001-AE)
16-Lead Dual-In-Line Welded-Seal Ceramic Package

SYMBOL	INCHES		NOTE	MILLIMETERS	
	MIN.	MAX.		MIN.	MAX.
A	0.120	0.160		3.05	4.06
A ₁	0.020	0.065		0.51	1.65
B	0.014	0.020		0.356	0.508
B ₁	0.035	0.065		0.89	1.65
C	0.008	0.012	1	0.204	0.304
D	0.745	0.785		18.93	19.93
E	0.300	0.325		7.62	8.25
E ₁	0.240	0.260		6.10	6.60
e ₁	0.100 TP		2	2.54 TP	
e _A	0.300 TP		2, 3	7.62 TP	
L	0.125	0.150		3.18	3.81
L ₂	0.000	0.030		0.000	0.76
a	0°	15°	4	0°	15°
N	16		5	16	
N ₁	0		6	0	
Q ₁	0.050	0.085		1.27	2.15
S	0.015	0.060		0.39	1.52

92SS-4266R5

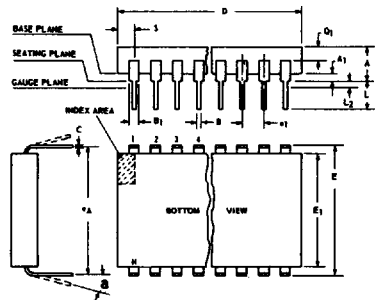

NOTES:

Refer to Rules for Dimensioning (JEDEC Publication No. 95) for Axial Lead Product Outlines.

- When this device is supplied solder-dipped, the maximum lead thickness (narrow portion) will not exceed 0.013" (0.33 mm).
- Leads within 0.005" (0.12 mm) radius of True Position (TP) at gauge plane with maximum material condition and unit installed.
- e_A applies in zone L_2 when unit installed.
- a applies to spread leads prior to installation.
- N is the maximum quantity of lead positions.
- N_1 is the quantity of allowable missing leads.

(D) SUFFIX (JEDEC MO-015-AG)
24-Lead Dual-In-Line Welded-Seal Ceramic Package

SYMBOL	INCHES		NOTE	MILLIMETERS	
	MIN.	MAX.		MIN.	MAX.
A	0.090	0.200		2.29	5.08
A ₁	0.020	0.070		0.51	1.78
B	0.015	0.020		0.381	0.508
B ₁	0.045	0.055		1.143	1.397
C	0.008	0.012	1	0.204	0.304
D	1.15	1.22		29.21	30.98
E	0.600	0.625		15.24	15.87
E ₁	0.480	0.520		12.20	13.20
e ₁	0.100 TP		2	2.54 TP	
e _A	0.600 TP		2, 3	15.24 TP	
L	0.100	0.180		2.54	4.57
L ₂	0.000	0.030		0.00	0.76
a	0°	15°	4	0°	15°
N	24		5	24	
N ₁	0		6	0	
Q ₁	0.020	0.080		0.51	2.03
S	0.020	0.060		0.51	1.52

92CS-19948R4

(D) SUFFIX (JEDEC MO-015-AH)
28-Lead Dual-In-Line Welded-Seal Ceramic Package

SYMBOL	INCHES		NOTE	MILLIMETERS	
	MIN.	MAX.		MIN.	MAX.
A	0.090	0.200		2.29	5
A ₁	0	0.070	2	0	1.77
B	0.015	0.020		0.381	0.508
B ₁	0.015	0.065		0.39	1.39
C	0.008	0.012	1	0.204	0.304
D	1.380	1.420		35.06	36.06
E	0.600	0.625		15.24	15.87
E ₁	0.485	0.515		12.32	13.08
e ₁	0.100 TP		2	2.54 TP	
e _A	0.600 TP		2, 3	15.24 TP	
L	0.100	0.200		2.6	5
L ₂	0	0.030		0	0.76
a	0°	15°	4	0°	15°
N	28		5	28	
N ₁	0		6	0	
Q ₁	0.020	0.070		0.51	1.77
S	0.040	0.070		1.02	1.77

92CM-20250R2

TO-5 Style Package

(T) SUFFIX (JEDEC MO-006-AG)
12-Lead Metal Package

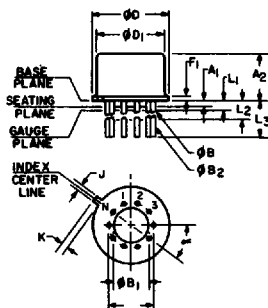

92CS-19774

SYMBOL	INCHES		NOTE	MILLIMETERS	
	MIN.	MAX.		MIN.	MAX.
a	0.230		2	5.84 TP	
A ₁	0	0		0	0
A ₂	0.165	0.185		4.19	4.70
φB	0.016	0.019	3	0.407	0.482
φB ₁	0	0		0	0
φB ₂	0.016	0.021	3	0.407	0.533
φD	0.335	0.370		8.51	9.39
φD ₁	0.305	0.335		7.75	8.50
F ₁	0.020	0.040		0.51	1.01
j	0.028	0.034		0.712	0.863
k	0.029	0.045	4	0.74	1.14
L ₁	0.000	0.050	3	0.00	1.27
L ₂	0.250	0.500	3	6.4	12.7
L ₃	0.500	0.562	3	12.7	14.27
a	30° TP			30° TP	
N	12		6	12	
N ₁	1		5	1	

NOTES:

- Refer to Rules for Dimensioning Axial Lead Product Outlines.
- Leads at gauge plane within 0.007" (0.178 mm) radius of True Position (TP) at maximum material condition.
- φB applies between L₁ and L₂. φB₂ applies between L₂ and 0.500" (12.70 mm) from seating plane. Diameter is uncontrolled in L₁ and beyond 0.500" (12.70 mm).
- Measure from Max. φD.
- N₁ is the quantity of allowable missing leads.
- N is the maximum quantity of lead positions.

Dimensional Outlines (Cont'd)

DUAL-IN-LINE SIDE-BRAZED CERAMIC PACKAGES

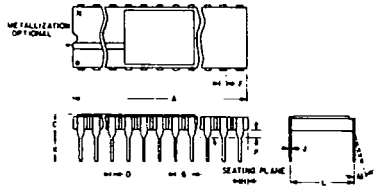

(D) SUFFIX 18-Lead Dual-In-Line Side-Brazed Ceramic Package

SYMBOL	INCHES		NOTE	MILLIMETERS	
	MIN.	MAX.		MIN.	MAX.
A	0.890	0.915		22.606	23.241
C	—	0.200		—	5.080
D	0.015	0.021		0.381	0.533
F	0.054	REF.	1	1.371	REF.
G	0.100	BSC	1	2.54	BSC
H	0.035	0.065		0.889	1.651
J	0.008	0.012	3	0.203	0.304
K	0.125	0.150		3.175	3.810
L	0.290	0.310	2	7.366	7.874
M	—	0°		0°	15°
P	0.025	0.045		0.635	1.143
N	18			18	

92CS-27231R1

(D) SUFFIX 22-Lead Dual-In-Line Side-Brazed Ceramic Package

SYMBOL	INCHES		NOTE	MILLIMETERS	
	MIN.	MAX.		MIN.	MAX.
A	1.065	1.100		27.05	27.94
C	0.085	0.145		2.16	3.68
D	0.017	0.023		0.43	0.58
F	0.040	REF.	1	1.02	REF.
G	0.100	BSC	1	2.54	BSC
H	0.030	0.070		0.76	1.78
J	0.008	0.012	3	0.20	0.30
K	0.125	0.175		3.18	4.45
L	0.380	0.420	2	9.65	10.67
M	—	7°		—	7°
P	0.025	0.050		0.64	1.27
N	22			22	

92CS-25186R2

NOTES:

- Leads within 0.005" (0.13 mm)-radius of True Position at maximum material condition.
- Dimension "L" to center of leads when formed parallel.
- When this device is supplied solder-dipped, the maximum lead thickness (narrow portion) will not exceed 0.013" (0.33 mm).

(D) SUFFIX 24-Lead Dual-In-Line Side-Brazed Ceramic Package

SYMBOL	INCHES		NOTE	MILLIMETERS	
	MIN.	MAX.		MIN.	MAX.
A	1.180	1.220		29.98	30.98
C	0.085	0.145		2.16	3.68
D	0.015	0.023		0.39	0.58
F	0.040	REF.		1.02	REF.
G	0.100	BSC	1	2.54	BSC
H	0.030	0.070		0.77	1.77
J	0.008	0.012	3	0.21	0.30
K	0.125	0.175		3.18	4.44
L	0.580	0.620	2	14.74	15.74
M	—	7°		—	7°
P	0.025	0.050		0.64	1.27
N	24			24	

92CS-30968R1

(D) SUFFIX 40-Lead Dual-In-Line Side-Brazed Ceramic Package

SYMBOL	INCHES		NOTE	MILLIMETERS	
	MIN.	MAX.		MIN.	MAX.
A	1.980	2.020		50.30	51.30
C	0.095	0.155		2.43	3.93
D	0.017	0.023		0.43	0.58
F	0.050	REF.		1.27	REF.
G	0.100	BSC	1	2.54	BSC
H	0.030	0.070		0.76	1.78
J	0.008	0.012	3	0.20	0.30
K	0.125	0.175		3.18	4.45
L	0.580	0.620	2	14.74	15.74
M	—	7°		—	7°
P	0.025	0.050		0.64	1.27
N	40			40	

92CM-27029R2

Dual-In-Line Plastic and Frit-Seal Ceramic Packages

(E) SUFFIX (JEDEC MO-001-AN) 8-Lead Dual-In-Line Plastic (Mini-DIP) Package

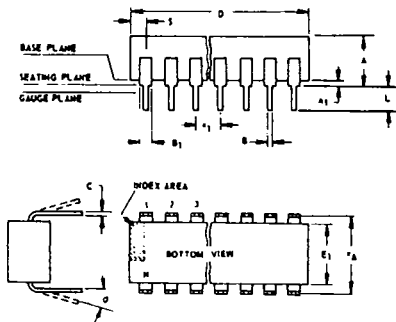

SYMBOL	INCHES		NOTE	MILLIMETERS	
	MIN.	MAX.		MIN.	MAX.
A	0.155	0.200		3.94	5.08
A ₁	0.020	0.050		0.508	1.27
B	0.014	0.020		0.356	0.508
B ₁	0.035	0.065		0.889	1.65
C	0.008	0.012	1	0.203	0.304
D	0.370	0.400		9.40	10.16
E	0.300	0.325		7.62	8.25
E ₁	0.240	0.260		6.10	6.60
e ₁	0.100	TP	2	2.54	TP
e _A	0.300	TP	2, 3	7.62	TP
L	0.125	0.150		3.18	3.81
L ₂	0.000	0.030		0.000	0.762
a	0	15	4	0	15
N	8		5	8	
N ₁	0		6	0	
O ₁	0.040	0.075		1.02	1.90
S	0.015	0.060		0.381	1.52

92CS-24026R1

NOTES:

Refer to Rules for Dimensioning (JEDEC Publication No. 95) for Axial Lead Product Outlines.

- When this device is supplied solder-dipped, the maximum lead thickness (narrow portion) will not exceed 0.013".
- Leads within 0.005" (0.12 mm) radius of True Position (TP) at gauge plane with maximum material condition and unit installed.
- e_A applies in zone L₂ when unit installed.
- a applies to spread leads prior to installation.
- N is the maximum quantity of lead positions.
- N₁ is the quantity of allowable missing leads.

Dimensional Outlines (Cont'd)

Dual-In-Line Plastic and Frit-Seal Ceramic Packages (Cont'd)

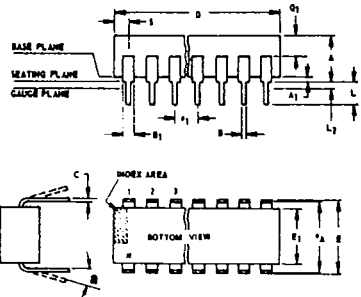

- NOTES:**
Refer to Rules for Dimensioning (JEDEC Publication No. 95) for Axial Lead Product Outlines.
- When this device is supplied solder dipped, the maximum lead thickness (narrow portion) will not exceed 0.013" (0.33 mm).
 - Leads within 0.005" (0.12 mm) radius of True Position (TP) at gauge plane with maximum material condition and unit installed.
 - e_A applies in zone L₂ when unit installed.
 - a applies to spread leads prior to installation.
 - N is the maximum quantity of lead positions.
 - N₁ is the quantity of allowable missing leads.

(E) and (F) SUFFIXES (JEDEC MO-001-AB) 14-Lead Dual-In-Line Plastic or Frit-Seal Ceramic Package

SYMBOL	INCHES		NOTE	MILLIMETERS	
	MIN.	MAX.		MIN.	MAX.
A	0.155	0.200		3.94	5.08
A ₁	0.020	0.050		0.51	1.27
B	0.014	0.020		0.356	0.508
B ₁	0.050	0.065		1.27	1.65
C	0.008	0.012	1	0.204	0.304
D	0.745	0.770		18.93	19.55
E	0.300	0.325		7.62	8.25
E ₁	0.240	0.260		6.10	6.60
e ₁	0.100 TP		2	2.54 TP	
e _A	0.300 TP		2, 3	7.62 TP	
L	0.125	0.150		3.18	3.81
L ₂	0.000	0.030		0.000	0.76
a	0°	15°	4	0°	15°
N	14		5	14	
N ₁	0		6	0	
Q ₁	0.040	0.075		1.02	1.90
S	0.065	0.090		1.66	2.28

92SS-4296R3

(E) and (F) SUFFIXES (JEDEC MO-001-AC) 16-Lead Dual-In-Line Plastic or Frit-Seal Ceramic Package

SYMBOL	INCHES		NOTE	MILLIMETERS	
	MIN.	MAX.		MIN.	MAX.
A	0.155	0.200		3.94	5.08
A ₁	0.020	0.050		0.51	1.27
B	0.014	0.020		0.356	0.508
B ₁	0.035	0.065		0.89	1.65
C	0.008	0.012	1	0.204	0.304
D	0.745	0.785		18.93	19.93
E	0.300	0.325		7.62	8.25
E ₁	0.240	0.260		6.10	6.60
e ₁	0.100 TP		2	2.54 TP	
e _A	0.300 TP		2, 3	7.62 TP	
L	0.125	0.150		3.18	3.81
L ₂	0.000	0.030		0.000	0.76
a	0°	15°	4	0°	15°
N	16		5	16	
N ₁	0		6	0	
Q ₁	0.040	0.075		1.02	1.90
S	0.015	0.060		0.39	1.52

92CM-15967R4

(E) SUFFIX 18-Lead Dual-In-Line Plastic Package

SYMBOL	INCHES		NOTE	MILLIMETERS	
	MIN.	MAX.		MIN.	MAX.
A	0.155	0.200		3.94	5.08
A ₁	0.020	0.050		0.508	1.27
B	0.014	0.020		0.356	0.508
B ₁	0.035	0.065		0.89	1.65
C	0.008	0.012	1	0.204	0.304
D	0.845	0.885		21.47	22.47
E ₁	0.240	0.260		6.10	6.60
e ₁	0.100 TP		2	2.54 TP	
e _A	0.300 TP		2, 3	7.62 TP	
L	0.125	0.150		3.18	3.81
a	0°	15°	4	0°	15°
N	18		5	18	
N ₁	0		6	0	
S	0.015	0.060		0.39	1.52

92CS-30630

(E) SUFFIX 22-Lead Dual-In-Line Plastic Package

SYMBOL	INCHES		NOTE	MILLIMETERS	
	MIN.	MAX.		MIN.	MAX.
A	0.155	0.200		3.94	5.08
A ₁	0.020	0.050		0.508	1.27
B	0.015	0.020		0.381	0.508
B ₁	0.035	0.065		0.89	1.65
C	0.008	0.012	1	0.204	0.304
D		1.120			28.44
E	0.390	0.420		9.91	10.66
E ₁	0.345	0.355		8.77	9.01
e ₁	0.100 TP		2	2.54 TP	
e _A	0.400 TP		2, 3	10.16 TP	
L	0.125	0.150		3.18	3.81
L ₂	0	0.030		0	0.762
a	2°	15°	4	2°	15°
N	22		5	22	
N ₁	0		6	0	
Q ₁	0.055	0.085		1.40	2.15
S	0.015	0.060		0.381	1.27

92CS-30830

(F) SUFFIX (JEDEC MO-001-AG) 16-Lead Dual-In-Line Frit-Seal Ceramic Package

SYMBOL	INCHES		NOTE	MILLIMETERS	
	MIN.	MAX.		MIN.	MAX.
A	0.165	0.210		4.20	5.33
A ₁	0.015	0.045		0.381	1.14
B	0.015	0.020		0.381	0.508
B ₁	0.045	0.070		1.15	1.77
C	0.009	0.011	1	0.229	0.279
D	0.750	0.795		19.05	20.19
E	0.295	0.325		7.50	8.25
E ₁	0.245	0.300		6.23	7.62
e ₁	0.100 TP		2	2.54 TP	
e _A	0.300 TP		2, 3	7.62 TP	
L	0.120	0.160		3.05	4.06
L ₂	0.000	0.030		0.000	0.76
a	2°	15°	4	2°	15°
N	16		5	16	
N ₁	0		6	0	
Q ₁	0.050	0.080		1.27	2.03
S	0.010	0.060		0.254	1.52

92CM-22284R1

(E) and (F) SUFFIXES (JEDEC MO-015-AA) 24-Lead Dual-In-Line Plastic or Frit-Seal Ceramic Package

SYMBOL	INCHES		NOTE	MILLIMETERS	
	MIN.	MAX.		MIN.	MAX.
A	0.120	0.250		3.10	6.30
A ₁	0.020	0.070		0.51	1.77
B	0.016	0.020		0.407	0.508
B ₁	0.028	0.070		0.72	1.77
C	0.008	0.012	1	0.204	0.304
D	1.20	1.29		30.48	32.76
E	0.600	0.625		15.24	15.87
E ₁	0.515	0.580		13.09	14.73
e ₁	0.100 TP		2	2.54 TP	
e _A	0.600 TP		2, 3	15.24 TP	
L	0.100	0.200		2.54	5.00
L ₂	0.000	0.030		0.00	0.76
a	0°	15°	4	0°	15°
N	24		5	24	
N ₁	0		6	0	
Q ₁	0.040	0.075		1.02	1.90
S	0.040	0.100		1.02	2.54

92CS26938R2

(E) SUFFIX 40-Lead Dual-In-Line Plastic Package

SYMBOL	INCHES		NOTE	MILLIMETERS	
	MIN.	MAX.		MIN.	MAX.
A	0.120	0.250		3.10	6.30
A ₁	0.020	0.070		0.51	1.77
B	0.016	0.020		0.407	0.508
B ₁	0.028	0.070		0.72	1.77
C	0.008	0.012	1	0.204	0.304
D	2.000	2.090		50.80	53.09
E ₁	0.515	0.580		13.09	14.73
e ₁	0.100 TP		2	2.54 TP	
e _A	0.600 TP		2, 3	15.24 TP	
L	0.100	0.200		2.54	5.00
L ₂	0.000	0.030		0.00	0.76
a	0°	15°	4	0°	15°
N	40		5	40	
N ₁	0		6	0	
Q ₁	0.065	0.095		1.66	2.41
S	0.040	0.100		1.02	2.54

92CS-30959

Dimensional Outlines (Cont'd)

Ceramic Flat Packs

(K) SUFFIX (JEDEC MO-004-AF)

14-Lead

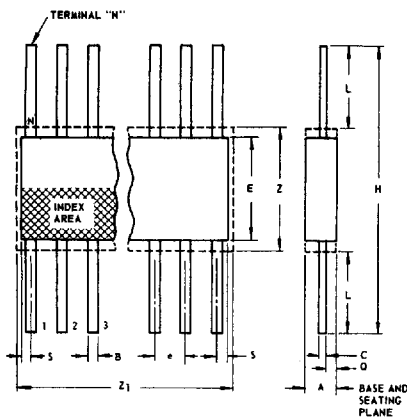

SYMBOL	INCHES		NOTE	MILLIMETERS	
	MIN.	MAX.		MIN.	MAX.
A	0.008	0.100		0.21	2.54
B	0.015	0.019	1	0.381	0.482
C	0.003	0.006	1	0.077	0.152
e	0.050 TP		2	1.27 TP	
E	0.200	0.300		5.1	7.6
H	0.600	1.000		15.3	25.4
L	0.150	0.350		3.9	8.8
N	14		3	14	
Q	0.005	0.050		0.13	1.27
S	0.000	0.050		0.00	1.27
Z	0.300		4	7.62	
Z ₁	0.400		4	10.16	

928S-4300R3

NOTES:

1. Refer to JEDEC Publication No. 95 for Rules for Dimensioning Peripheral Lead Outlines.
2. Leads within 0.005" (0.12 mm) radius of True Position (TP) at maximum material condition.
3. N is the maximum quantity of lead positions.
4. Z and Z₁ determine a zone within which all body and lead irregularities lie.

(K) SUFFIX (JEDEC MO-004-AG)

16-Lead

SYMBOL	INCHES		NOTE	MILLIMETERS	
	MIN.	MAX.		MIN.	MAX.
A	0.008	0.100		0.21	2.54
B	0.015	0.019	1	0.381	0.482
C	0.003	0.006	1	0.077	0.152
e	0.050 TP		2	1.27 TP	
E	0.200	0.300		5.1	7.6
H	0.600	1.000		15.3	25.4
L	0.150	0.350		3.9	8.8
N	16		3	16	
Q	0.005	0.050		0.13	1.27
S	0.000	0.025		0.00	0.63
Z	0.300		4	7.62	
Z ₁	0.400		4	10.16	

92CS-17271R3

(K) SUFFIX

24-Lead

SYMBOL	INCHES		NOTE	MILLIMETERS	
	MIN.	MAX.		MIN.	MAX.
A	0.075	0.120		1.91	3.04
B	0.018	0.022	1	0.458	0.558
C	0.004	0.007	1	0.102	0.177
e	0.050 TP		2	1.27 TP	
E	0.600	0.700		15.24	17.78
H	1.150	1.350		29.21	34.29
L	0.225	0.325		5.72	8.25
N	24		3	24	
Q	0.035	0.070		0.89	1.77
S	0.060	0.110	1	1.53	2.79
Z	0.700		4	17.78	
Z ₁	0.750		4	19.05	

92CS-19949R2

(K) SUFFIX

28-Lead

SYMBOL	INCHES		NOTE	MILLIMETERS	
	MIN.	MAX.		MIN.	MAX.
A	0.075	0.120		1.91	3.04
B	0.018	0.022	1	0.458	0.558
C	0.004	0.007	1	0.102	0.177
e	0.050 TP		2	1.27 TP	
E	0.600	0.700		15.24	17.78
H	1.150	1.350		29.21	34.29
L	0.225	0.325		5.72	8.25
N	28		3	28	
Q	0.035	0.070		0.89	1.77
S	0	0.060	1	0	1.53
Z	0.700		4	17.78	
Z ₁	0.750		4	19.05	

92CS-20972