

# PRECISION 1.25 VOLT MICROPOWER VOLTAGE REFERENCE

ISSUE 2 - FEBRUARY 1997

ZRA124

## DEVICE DESCRIPTION

The ZRA124 uses a bandgap circuit design to achieve a precision micropower voltage reference of 1.24 volts. The device is available in small outline surface mount packages, ideal for applications where space saving is important, as well as packages for through hole requirements.

The ZRA124 design provides a stable voltage without an external capacitor and is stable with capacitive loads. The ZRA124 is recommended for operation between 50 $\mu$ A and 5mA and so is ideally suited to low power and battery powered applications.

Excellent performance is maintained to a suggested absolute maximum of 25mA, however the rugged design and 20 volt processing allows the reference to withstand transient effects and currents up to 200mA. Superior switching capability allows the device to reach stable operating conditions in only a few microseconds.

## FEATURES

- Small outline SOT23, SO8 and TO92 style packages

• No stabilising capacitor required

- Typical  $T_C$  30ppm/ $^{\circ}$ C
- Typical slope resistance 0.65 $\Omega$
- $\pm$  1% tolerance
- Industrial temperature range
- Operating current 50 $\mu$ A to 5mA
- Transient response, stable in less than 10 $\mu$ s

## APPLICATIONS

- Battery powered and portable equipment.
- Metering and measurement systems.
- Instrumentation.
- Precision power supplies.
- Test equipment.
- Data acquisition systems

## SCHEMATIC DIAGRAM

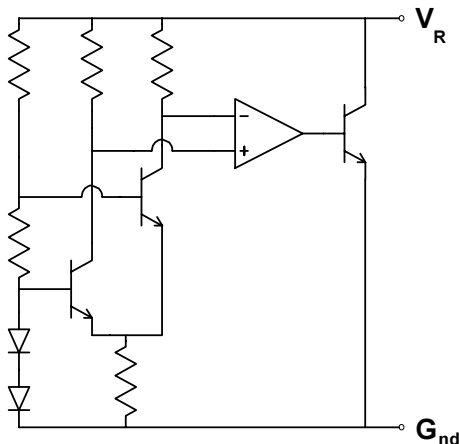

# ZRA124

## ABSOLUTE MAXIMUM RATING

Reverse Current	25mA
Forward Current	25mA
Operating Temperature	-40 to 85°C
Storage Temperature	-55 to 125°C

## Power Dissipation (T<sub>amb</sub>=25°C)

SOT23	330mW
E-Line, 3 pin (TO92)	500mW
E-Line, 2 pin (TO92)	500mW
SO8	625mW

## ELECTRICAL CHARACTERISTICS

### TEST CONDITIONS (Unless otherwise stated) T<sub>amb</sub>=25°C

SYMBOL	PARAMETER	CONDITIONS	LIMITS			TOL. %	UNITS
			MIN	TYP	MAX		
V <sub>R</sub>	Reverse Breakdown Voltage	I <sub>R</sub> =150μA	1.228	1.24	1.252	1	V
I <sub>MIN</sub>	Minimum Operating Current			30	50		μA
I <sub>R</sub>	Recommended Operating Current		0.05		5		mA
T <sub>C</sub> †	Average Reverse Breakdown Voltage Temp. Co.	I <sub>R(min)</sub> to I <sub>R(max)</sub>		30	90		ppm/°C
R <sub>S</sub> §	Slope Resistance			0.65	2		Ω
Z <sub>R</sub>	Reverse Dynamic Impedance	I <sub>R</sub> = 1mA f = 100Hz I <sub>AC</sub> = 0.1 I <sub>R</sub>		0.5	1		Ω
E <sub>N</sub>	Wideband Noise Voltage	I <sub>R</sub> = 150μA f = 100Hz to 10kHz		40			μV(rms)

$$\dagger T_C = \frac{V_R \text{ Change} \times 1000000}{V_R \times \text{Temperature Change}}$$

$$\S R_S = \frac{V_R \text{ Change}(I_R(\text{min}) \text{ to } I_R(\text{max}))}{I_R(\text{max}) - I_R(\text{min})}$$

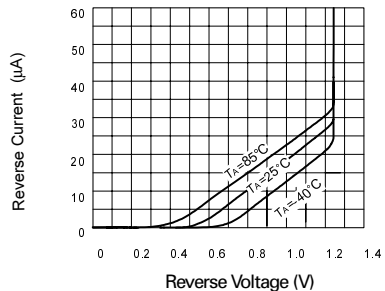

Reverse Characteristics

# ZRA124

## TYPICAL CHARACTERISTICS

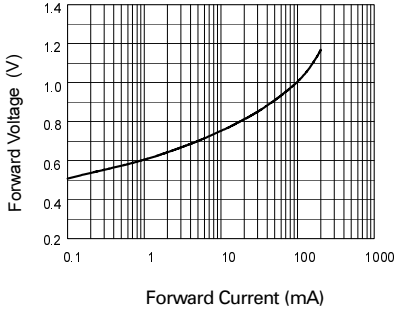

**Forward Characteristics**

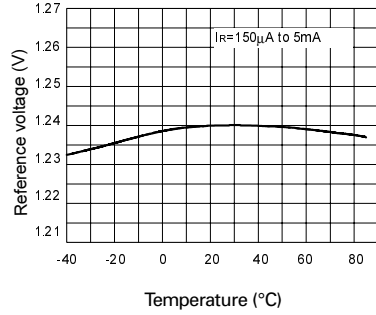

**Temperature Drift**

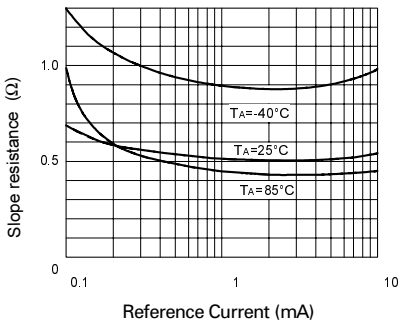

**Slope Resistance v Current**

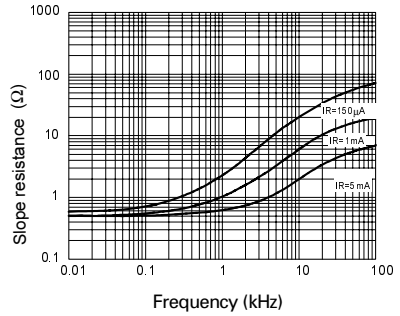

**Slope Resistance v Frequency**

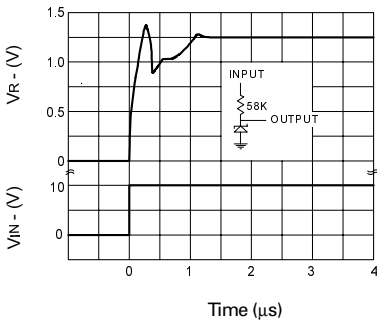

**Transient Response ( $I_R=150\mu\text{A}$ )**

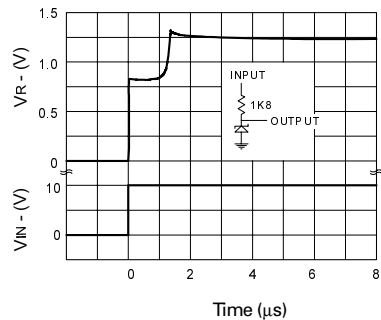

**Transient Response ( $I_R=5\text{mA}$ )**

# ZRA124

## CONNECTION DIAGRAMS

**E-Line, 2 pin Package Suffix – Y**

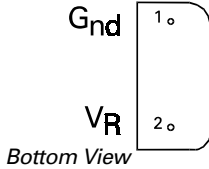

**E-Line, 3 pin, Rev Package Suffix – R**

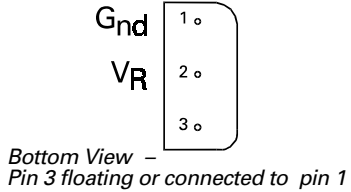

**E-Line, 3 pin Package Suffix – A**

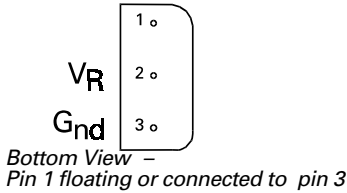

**SO8 Package Suffix – N8**

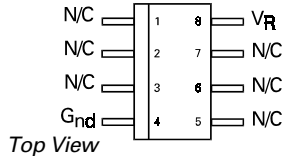

**SOT23 Package Suffix – F**

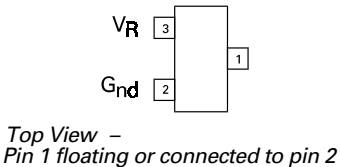

## ORDERING INFORMATION

Part No	Tol%	Package	Partmark
ZRA124A01	1	E-Line •	ZRA12401
ZRA124F01	1	SOT23	12C
ZRA124N801	1	SO8	ZRA12401
ZRA124R01	1	E-Line *	ZRA124R1
ZRA124Y01	1	E-Line †	ZRA12401

\* E-Line 3 pin Reversed

† E-Line 2 pin

• E-Line 3 pin