

3A Ultra Low Dropout Linear Regulator

General Description

The uP7706 is a 3A ultra low dropout linear regulator specifically designed for motherboard and notebook applications. This device works with dual supplies, a control input for the control circuitry and a power input as low as 1.2V for providing current to output. The uP7706 delivers high-current and ultra-low-drop output voltage as low as 0.8V for applications where V_{OUT} is very close to V_{IN} .

The uP7706 features comprehensive control and protection functions: a power on reset (POR) circuit for monitoring both control and power inputs for proper operation; an EN input for enabling or disabling the device, a power OK with time delay for indicating the output voltage status, a foldback current limit function, and a thermal shutdown function.

The uP7706 is available in PSOP-8 or VDFN6x5-8L packages with very low thermal resistance.

Applications

- ❑ Desktop PCs, Notebooks, and Workstations
- ❑ Graphic Cards
- ❑ Low Voltage Logic Supplies
- ❑ Microprocessor and Chipset Supplies
- ❑ Split Plane Microprocessor Supplies
- ❑ Advanced Graphics Cards Supplies
- ❑ SoundCards and Auxiliary Power Supplies
- ❑ SMPS Post Regulators

www.DataSheet4U.com

Features

- ❑ Works with 1.2~5.5V V_{IN}
 - Adjustable Output Voltage, Down to 0.8V
 - 1.5% Initial Accuracy
 - Excellent Line and Load Regulation
- ❑ 3A Guaranteed Output Current
 - 200mV @ 2A Dropout Voltage
- ❑ Very Low On-Resistance
 - 100m Ω typical
- ❑ V_{OUT} Pull Low Resistance when Disabled
- ❑ Low Reverse Leakage (Output to Input)
- ❑ V_{OUT} Power OK Signal
- ❑ Fast Transient Response
- ❑ Low External Component Count
- ❑ Low Cost and Easy to Use
- ❑ Enable Pin
- ❑ Over Current and Over Temperature Protection

Ordering Information

Order Number	Package Type	Remark
uP7706U8	PSOP-8	
uP7706ADC8	VDFN6x5 - 8L	

Note: uPI products are compatible with the current IPC/ JEDEC J-STD-020 and RoHS requirements. They are 100% matte tin (Sn) plating and suitable for use in SnPb or Pb-free soldering processes.

Pin Configuration & Typical Application Circuit

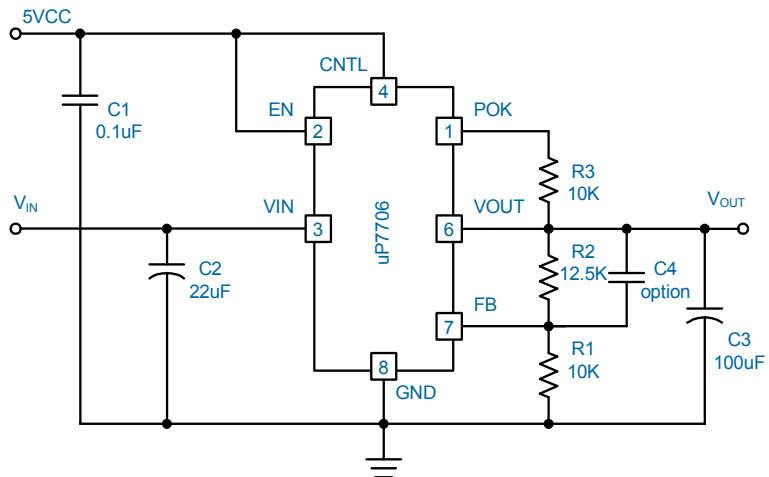
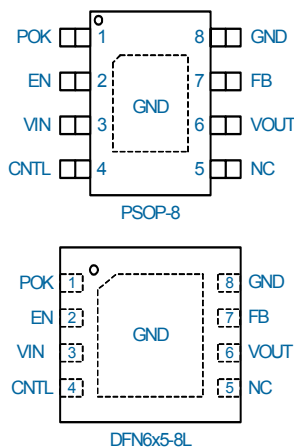

Functional Pin Description

Pin No.	Name	Pin Function
1	POK	Power OK Indication. This pin is an open-drain output and is set high impedance once V_{OUT} reaches 92% of its rating voltage.
2	EN	Enable Input. Pulling this pin below 0.8V turns the regulator off, reducing the quiescent current to a fraction of its operating value.
3	VIN	Input Voltage. This is the drain input to the power device that supply current to the output pin. Large bulk capacitors with low ESR should be placed physically close to this pin o prevent the input rail from dropping during large load transient. A 10uF ceramic capacitor is recommended at this pin.
4	CNTL	Supply Input for Control Circuit. This pin provides bias voltage to the control circuitry and driver for the pass transistor. The driving capability of output current is proportioned to the V_{CNTL} . For the device to regulate, the voltage on this pin must be at least 1.5V greater than the output voltage, and no less than V_{CNTL_MIN} .
5	NC	Not Internally Connected.
6	VOUT	Output Voltage. This pin is power output of the device. A pull low resistance exists when the device is disabled by pulling low the EN pin. To maintain adequate transient response to large load change, typical value of 1000uF Al electrolytic capacitor with 10uF ceramic capacitors are recommended to reduce the effects of current transients on VOUT.
7	FB	Feedback Voltage. This pin is the inverting input to the error amplifier. A resistor divider from the output to GND is used to set the regulation voltage as $V_{OUT} = 0.8 \times (R1+R2)/R1$ (V)
8	GND	Ground.
Exposed Pad	GND	Ground. The exposed pad acts the dominant power dissipation path and should be soldered to well design PCB pads as described in the <i>Application Informations Chapter</i> .

Functional Block Diagram

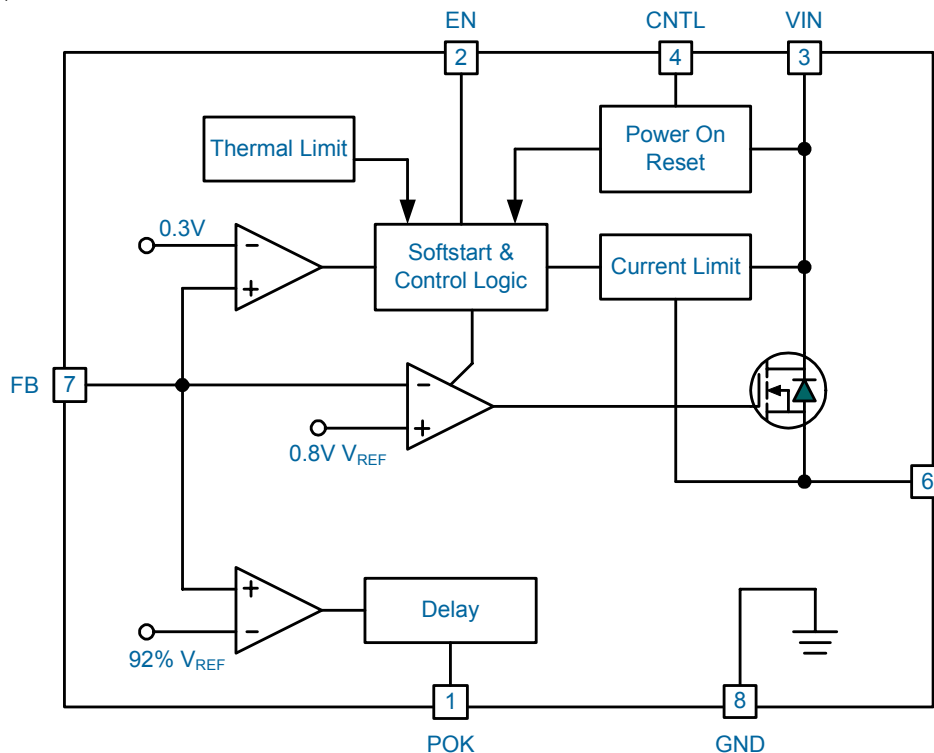

www.DataSheet4U.com

Functional Description

Definitions

Some important terminologies for LDO are specified below.

Dropout Voltage

The input/output voltage differential at which the regulator output no longer maintains regulation against further reductions in input voltage. Measured when the output drops 2% below its nominal value. Dropout voltage is affected by junction temperature, load current and minimum input supply requirements.

Line Regulation

The change in output voltage for a change in input voltage. The measurement is made under conditions of low dissipation or by using pulse techniques such that average chip temperature is not significantly affected.

Load Regulation

The change in output voltage for a change in load current at constant chip temperature. The measurement is made under conditions of low dissipation or by using pulse techniques such that average chip temperature is not significantly affected.

Maximum Power Dissipation

The maximum total device dissipation for which the regulator will operate within specifications.

Initialization

The uP7706 automatically initiates upon the receipt of supply voltage and power voltage. A power on reset circuit continuously monitors VIN and CNTL pins voltages with rising threshold levels of 1.0V and 2.7V respectively.

Chip Enable and Soft Start

The uP7706 features an enable pin for enable/disable control of the chip. Pulling V_{EN} lower than 0.8V disables the chip and reduces its quiescent current down to 1uA. When disabled, an internal MOSFET of 90Ω R_{DS(ON)} turns on to pull output voltage to ground. Pulling V_{EN} higher than 2.0V enables the output voltage, providing POR is recognized. The uP7706 features soft start function that limits inrush current for charging the output capacitors. The soft start time is typically 2.5ms.

Output Voltage Programming

Figure 1 shows a typical application of 2.5V to 1.8V conversion with a 5.0V control supply. The output voltage is sensed through a voltage divider and regulated to internal reference voltage V_{REF}. The output voltage is programmed as:

$$V_{OUT} = V_{REF} \times (R_1 + R_2) / R_1 = 0.8V \times (22.5k/10k) = 1.8V$$

It's recommended to maintain 50-100uA through the output divider network for a tight load and line regulation. The internal voltage reference is V_{REF} = 0.8V with 1.5% accuracy over full temperature range. This commands the use of 0.5% or better accuracy resistors to build a precision power supply.

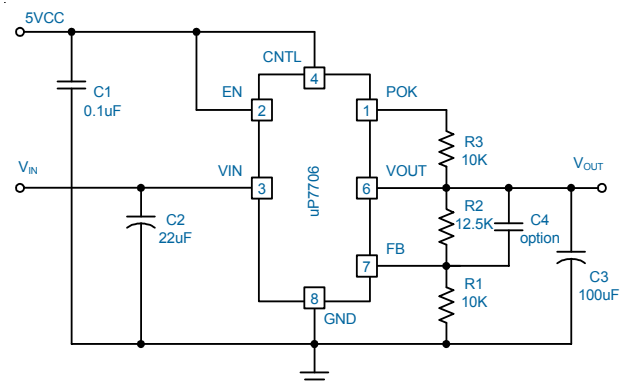

Figure 1. Typical application of 2.5V to 1.8V conversion with a 5.0V control supply

Over Current Protection

The uP7706 features a foldback over current protection function as shown in Figure 2. The current limit threshold level is proportional to V_{OUT}/V_{NOM} and is typically 4A when V_{OUT} = V_{NOM}, where V_{NOM} is the target output voltage. If the output continuously demands more current than the maximum current, output voltage will eventually drop below its nominal value. This, in turns, will lower its OCP threshold level. This will limit power dissipation in the device when over current limit happens. The power dissipation is near zero when the output is short circuited to ground.

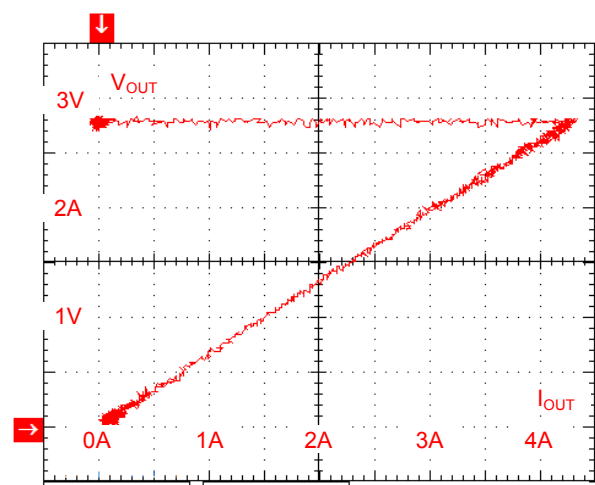

Figure 2. Current Limit Behavior

Absolute Maximum Rating

Control Input Voltage V_{CNTL} (Note 1)	-0.3V to +6V
Power Input Voltage V_{IN}	-0.3V to +6V
Other Pins	-0.3V to ($V_{CNTL} + 0.3V$)
Storage Temperature Range	-65°C to +150°C
Junction Temperature	150°C
Lead Temperature (Soldering, 10 sec)	260°C
ESD Rating (Note 2)	
HBM (Human Body Mode)	2kV
MM (Machine Mode)	200V

Thermal Information

Package Thermal Resistance (Note 3)	
PSOP-8 θ_{JA}	52°C/W
PSOP-8 θ_{JA}	5°C/W
VDFN6x5-8L θ_{JA}	45°C/W
VDFN6x5-8L θ_{JC}	4°C/W
Power Dissipation, P_D @ $T_A = 25^\circ\text{C}$	
PSOP-8	1.9W
VDFN6x5-8L	2.2W

Recommended Operation Conditions

Operating Junction Temperature Range (Note 4)	-40°C to +125°C
Operating Ambient Temperature Range	-40°C to +85°C
Supply Input Voltage, V_{CNTL}	+4.5V to +5.5V

Electrical Characteristics

($V_{CNTL} = 5V$, $T_A = 25^\circ\text{C}$, unless otherwise specified)

Parameter	Symbol	Test Conditions	Min	Typ	Max	Units
Supply Input Voltage						
Control Input Voltage	V_{CNTL}	$V_{OUT} = V_{REF}$	3.0	--	5.5	V
POR Threshold	$V_{CNTLRTH}$		--	2.7	--	V
POR Hysteresis	$V_{CNTLHYS}$		--	0.2	--	V
Power Input Voltage	V_{IN}	$V_{OUT} = V_{REF}$	1.0	--	5.5	V
Control Input Current in Shutdown	I_{CNTL_SD}	$V_{CNTL} = V_{IN} = 5.0V$, $I_{OUT} = 0A$, $V_{EN} = 0V$	--	20	30	uA
Control Input Current	I_{CNTL}	$V_{CNTL} = V_{IN} = V_{EN} = 5.0V$, $I_{OUT} = 0A$, $V_{OUT} = V_{REF}$	--	1.0	1.5	mA
Quiescent Current	I_Q	$V_{CNTL} = V_{IN} = V_{EN} = 5.0V$, $I_{OUT} = 0A$, $V_{OUT} = V_{REF}$	--	1.0	1.5	mA

Electrical Characteristics

Parameter	Symbol	Test Conditions	Min	Typ	Max	Units
Feedback Voltage						
Reference Voltage	V_{REF}	$V_{CNTL} = V_{IN} = V_{EN} = 5.0V, I_{OUT} = 0A, V_{OUT} = V_{REF}$	0.788	0.8	0.812	V
Feedback Input Current	I_{FB}		--	20	--	nA
V_{IN} Line Regulation	$V_{REF(LINE)}$	$1.2V < V_{IN} < 5.0V, V_{CNTL} = V_{EN} = 5.0V, I_{OUT} = 0A, V_{OUT} = V_{REF}$	--	0.01	0.1	%/V
V_{CNTL} Line Regulation	$V_{REF(CNTL)}$	$V_{IN} = 3.3V, I_{OUT} = 0A, V_{OUT} = V_{REF}$	--	0.01	0.1	%/V
Load Regulation	$V_{REF(LOAD)}$	$10mA < I_{OUT} < 3A, V_{CNTL} = V_{IN} = V_{EN} = 5.0V, V_{OUT} = V_{REF}$	--	0.8	1.5	%/A
Load Regulation over Temperature	$V_{REF(LOAD)}$	$10mA < I_{OUT} < 3A, V_{CNTL} = V_{IN} = V_{EN} = 5.0V, V_{OUT} = V_{REF}, -40^{\circ}C < T_J < 125^{\circ}C$	--	1.4	3	%
Dropout Voltage	V_{DROP}	$I_{OUT} = 2A, V_{CNTL} = V_{EN} = 5.0V, V_{OUT} = V_{REF}$	--	200	240	mV
		$I_{OUT} = 3A, V_{CNTL} = V_{EN} = 5.0V, V_{OUT} = V_{REF}$		300	360	
V_{OUT} Pull Low Resistance		$V_{CNTL} = V_{IN} = 5.0V, V_{EN} = 0V,$	--	90	--	Ω
Enable						
Enable High Level	V_{EN}		--	--	1.4	V
Disable Low Level	V_{SD}		0.8	--	--	V
EN Input Current	I_{EN}	$V_{EN} = V_{CNTL} = 5.0V$	--	12	20	μA
EN Input Impedance	Z_{EN}		--	65	--	K Ω
PWROK						
FB Power OK Threshold	V_{POKTH}	$I_{OUT} = 0A, V_{CNTL} = V_{IN} = V_{EN} = 5.0V, V_{OUT} = V_{REF}$	--	92	--	%
Power OK Hysteresis	V_{POKHYS}	$I_{OUT} = 0A, V_{CNTL} = V_{IN} = V_{EN} = 5.0V, V_{OUT} = V_{REF}$	--	8	--	%
Overcurrent Protection						
OCP Threshold Level	I_{OCP}	$V_{CNTL} = V_{IN} = V_{EN} = 5.0V, V_{OUT} = V_{REF}$	--	4	--	A
Output Short Circuit Current	I_{SC}	$V_{CNTL} = V_{IN} = V_{EN} = 5.0V, V_{OUT} = V_{REF}$	--	100	--	mA
Thermal Protection						
Thermal Shutdown Temperature	T_{SD}	$I_{OUT} = 0A, V_{CNTL} = V_{IN} = V_{EN} = 5.0V, V_{OUT} = V_{REF}$	--	170	--	$^{\circ}C$
Thermal Shutdown Hysteresis	T_{SDHYS}	$I_{OUT} = 0A, V_{CNTL} = V_{IN} = V_{EN} = 5.0V, V_{OUT} = V_{REF}$	--	30	--	$^{\circ}C$

Note 1. Stresses listed as the above "Absolute Maximum Ratings" may cause permanent damage to the device. These are for stress ratings. Functional operation of the device at these or any other conditions beyond those indicated in the operational sections of the specifications is not implied. Exposure to absolute maximum rating conditions for extended periods may remain possibility to affect device reliability.

Note 2. Devices are ESD sensitive. Handling precaution recommended.

Note 3. θ_{JA} is measured in the natural convection at $T_A = 25^{\circ}C$ on a low effective thermal conductivity test board of JEDEC 51-3 thermal measurement standard.

Note 4. The device is not guaranteed to function outside its operating conditions.

Typical Operation Characteristics

Power On from V_{IN}

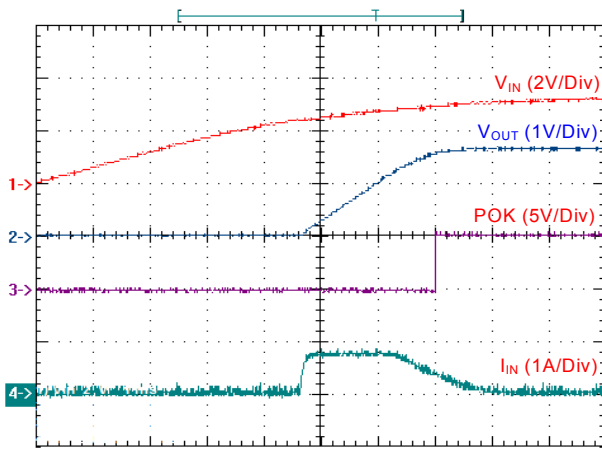

$V_{CNTL} = 5V, V_{IN} = 3.3V, C_{OUT} = 1000\mu F, \text{No Load.}$

Power On from V_{CNTL}

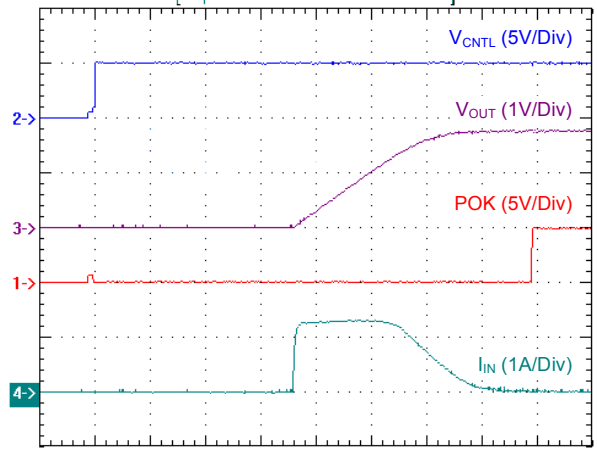

$V_{CNTL} = 5V, V_{IN} = 3.3V, C_{OUT} = 1000\mu F, \text{No Load.}$

Turn On from EN

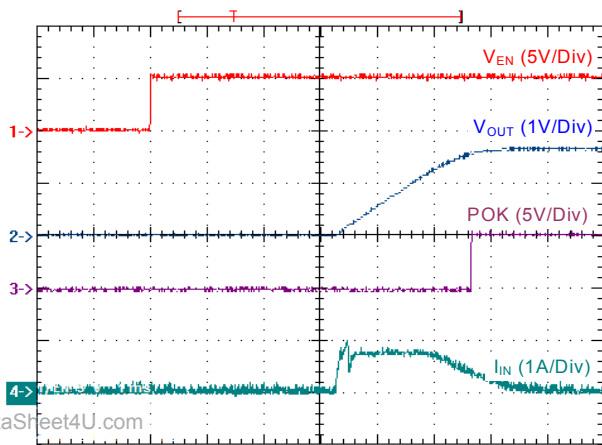

$V_{CNTL} = 5V, V_{IN} = 3.3V, C_{OUT} = 1000\mu F, \text{No Load.}$

Dropout Voltage vs. Output Current

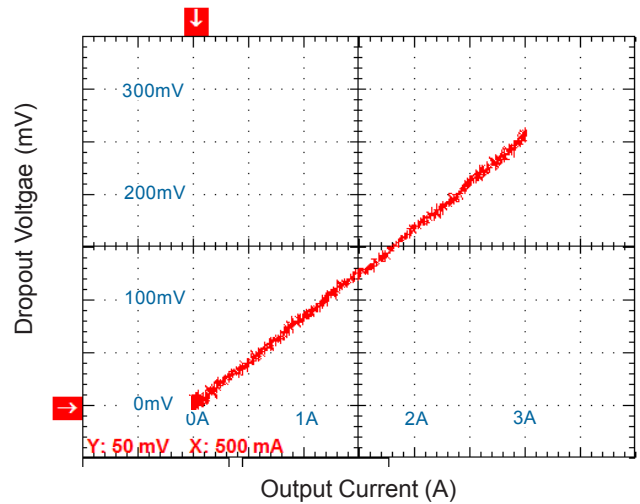

Output Short Circuit

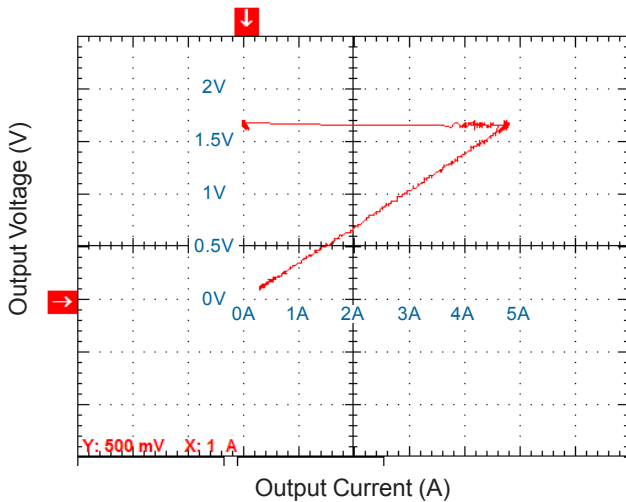

Output Voltage vs. Output Current

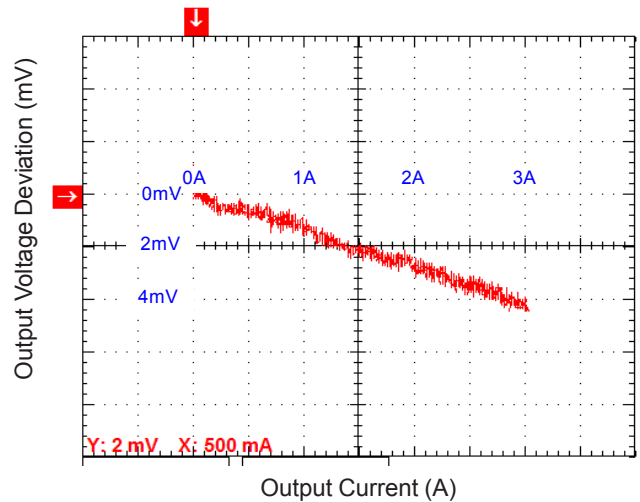

Typical Operation Characteristics

Load Transient Response

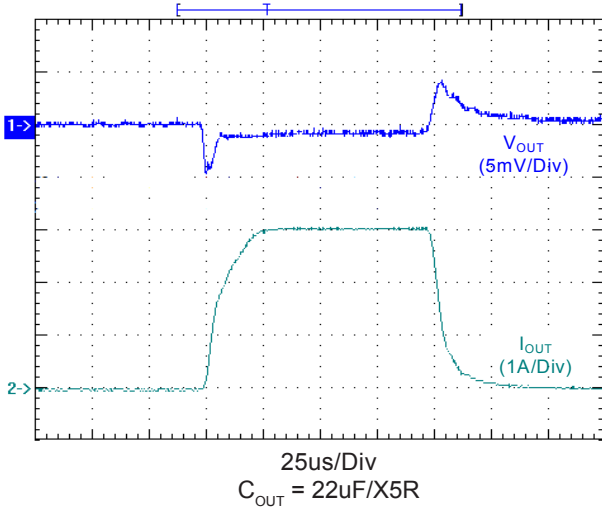

Quiescent Current vs. Input Voltage

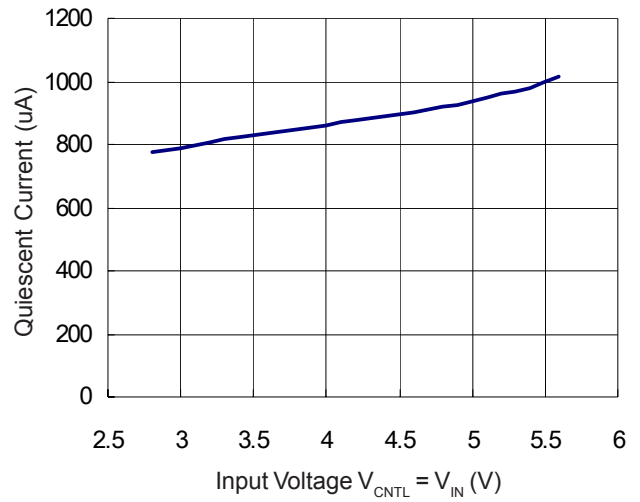

Shutdown Current vs. Input Voltage

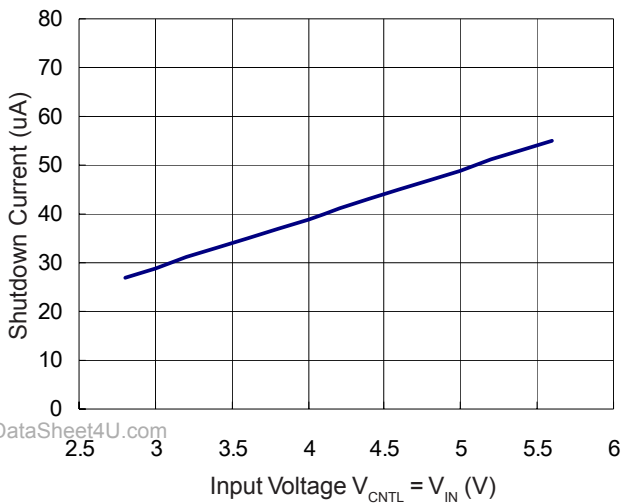

Line Regulation

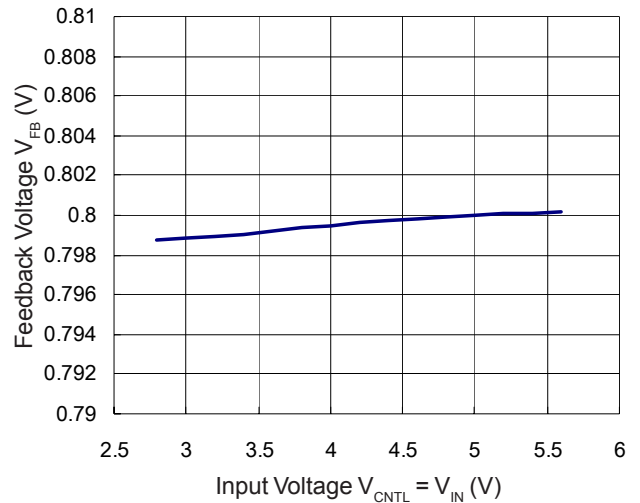

Quiescent Current vs. Temperature

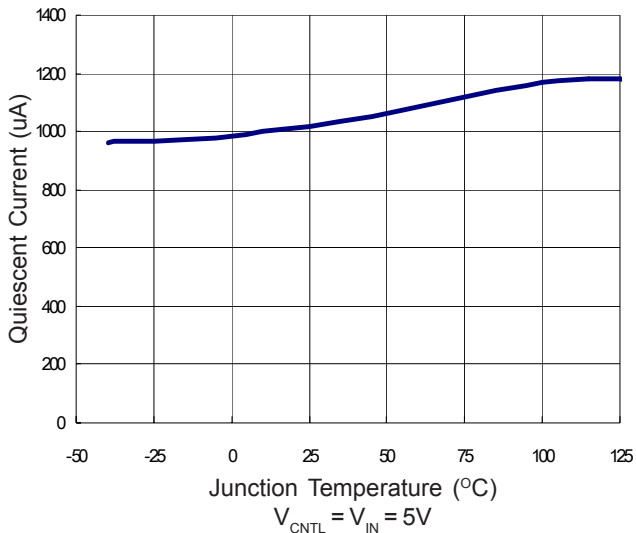

Shutdown Current vs. Temperature

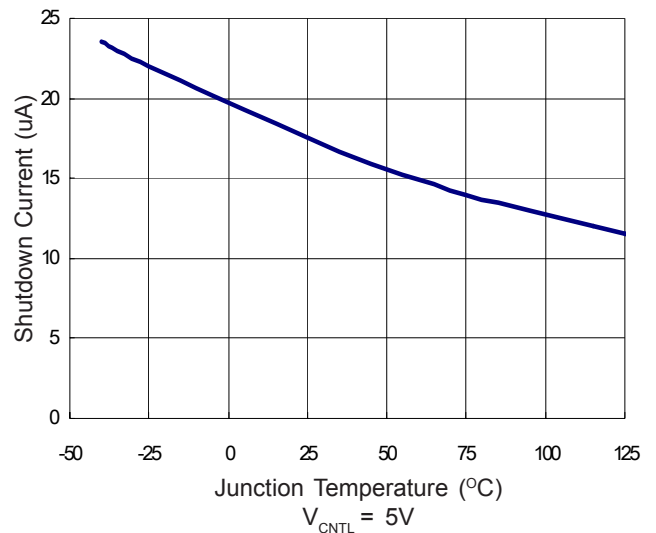

Typical Operation Characteristics

FB Voltage vs. Temperature

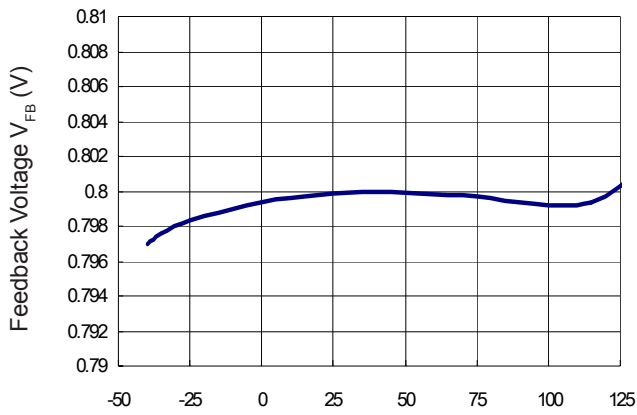

Junction Temperature (°C)
 $V_{\text{CNTL}} = 5\text{V}, V_{\text{IN}} = V_{\text{OUT}} + 1\text{V}$

On Resistance vs. Temperature

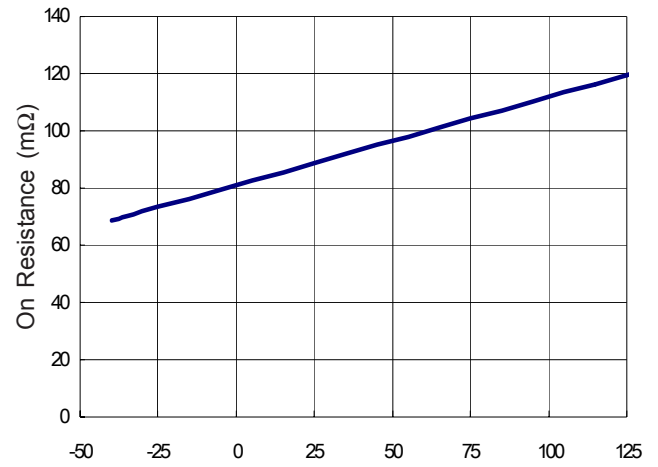

Junction Temperature (°C)
 $V_{\text{CNTL}} = 5\text{V}, V_{\text{OUT}} = 1.6\text{V}$

Application Information

θ_{JC} is on the exposed pad for PSOP-8 package.

Given power dissipation P_D , ambient temperature and thermal resistance θ_{JA} , the junction temperature is calculated as:

$$T_J = T_A + \Delta T_{JA} = T_A + P_D \times \theta_{JA}$$

To limit the junction temperature within its maximum rating, the allowable maximum power dissipation is calculated as:

$$P_{D(MAX)} = (T_{J(MAX)} - T_A) / \theta_{JA}$$

where $T_{J(MAX)}$ is the maximum operation junction temperature 125°C, T_A is the ambient temperature and the θ_{JA} is the junction to ambient thermal resistance. θ_{JA} of PSOP-8 packages is 75°C/W on JEDEC 51-7 (4 layers, 2S2P) thermal test board with minimum copper area. The maximum power dissipation at $T_A = 25^\circ\text{C}$ can be calculated as:

$$P_{D(MAX)} = (125^\circ\text{C} - 25^\circ\text{C}) / 75^\circ\text{C/W} = 1.33\text{W}$$

The thermal resistance θ_{JA} highly depends on the PCB design. Copper plane under the exposed pad is an effective heatsink and is useful for improving thermal conductivity. Figure 3 show the relationship between thermal resistance θ_{JA} vs. copper area on a standard JEDEC 51-7 (4 layers, 2S2P) thermal test board at $T_A = 25^\circ\text{C}$. A 50mm² copper plane reduces θ_{JA} from 75°C/W to 50°C/W and increases maximum power dissipation from 1.33W to 2W.

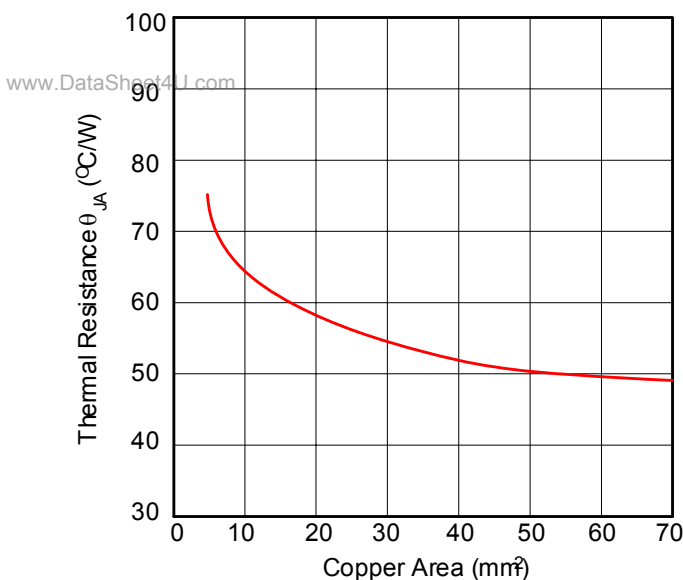

Figure 3. Thermal Resistance θ_{JA} vs. Copper Area

Figure 4 illustrated the recommended PCB layout for best thermal performance.

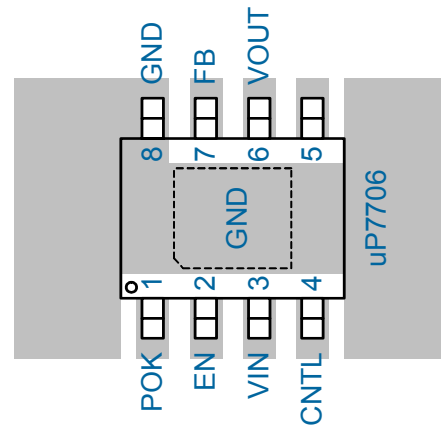

Figure 4. Recommended PCB Layout.

Layout Consideration

1. Place a local bypass capacitor as closed as possible to the VIN pin. Use short and wide traces to minimize parasitic resistance and inductance.
2. The exposed pad should be soldered on GND plane with maximum area and with multiple vias to inner layer of ground plane for improved thermal performance.
3. Connect voltage divider directly to the point where regulation is required. Place voltage divider close to the device.

Application Information

PSOP-8 Package

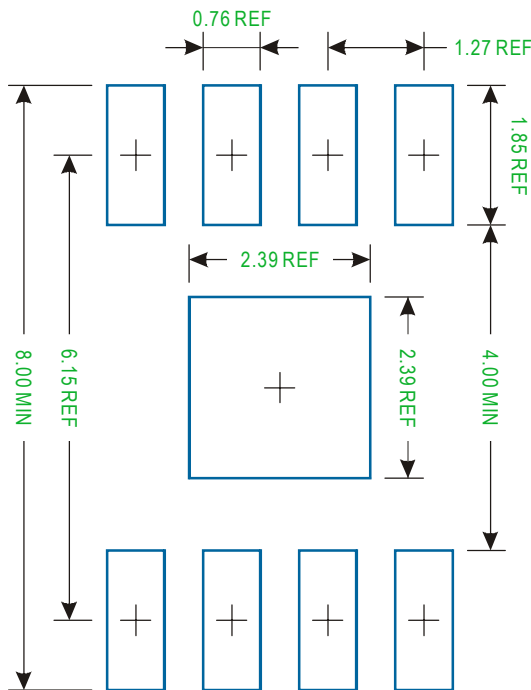

Recommended Solder Pad Layout

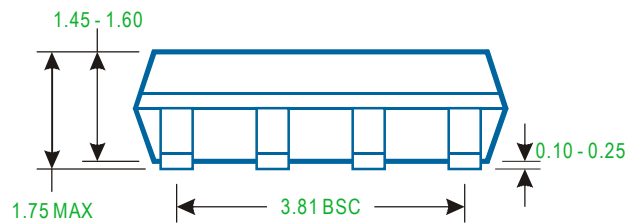
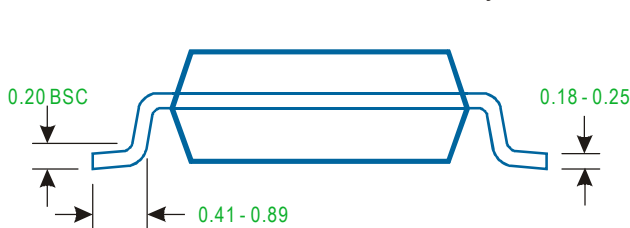
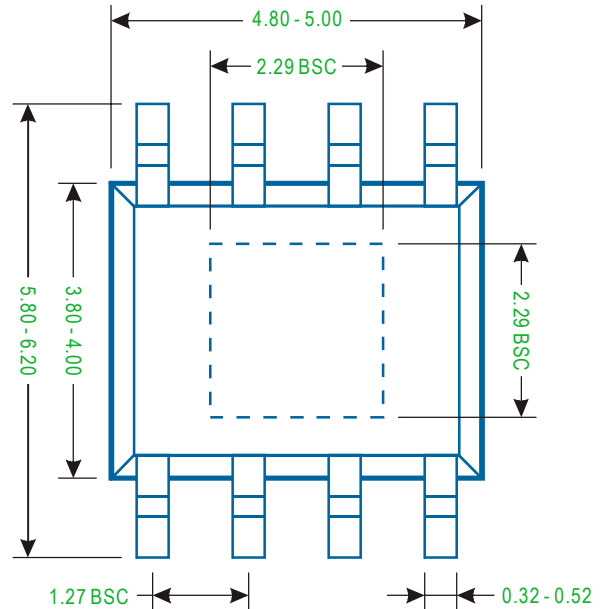

www.DataSheet4U.com

Note

1. Package Outline Unit Description:

BSC: Basic. Represents theoretical exact dimension or dimension target

MIN: Minimum dimension specified.

MAX: Maximum dimension specified.

REF: Reference. Represents dimension for reference use only. This value is not a device specification.

TYP: Typical. Provided as a general value. This value is not a device specification.

2. Dimensions in Millimeters.

3. Drawing not to scale.

4. These dimensions no not include mold flash or protrusions. Mold flash or protrusions shell not exceed 0.15mm.

Application Information

VDFN6x5-8L Package

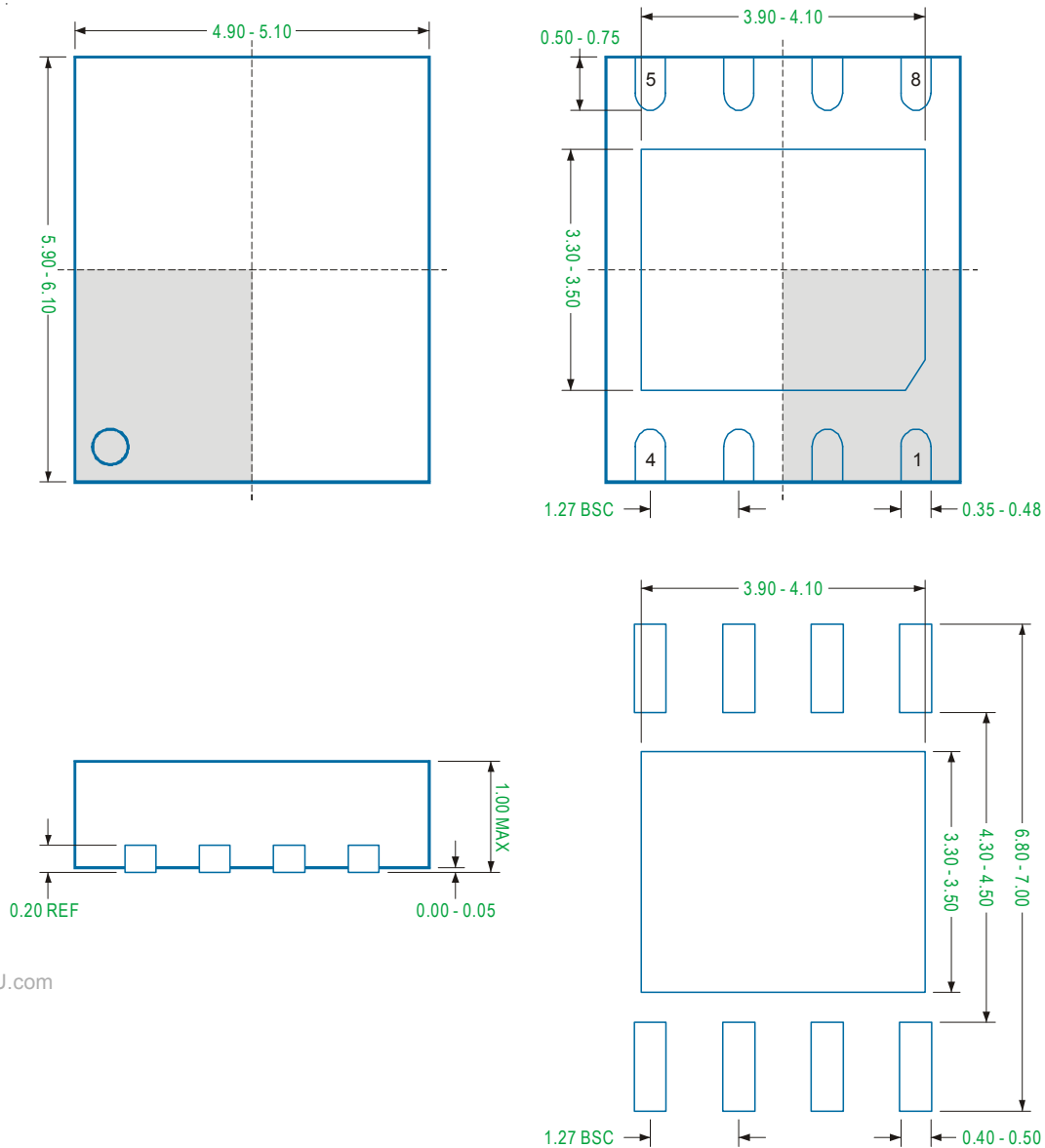

Recommended Solder Pitch and Dimensions

Note

1. Package Outline Unit Description:

BSC: Basic. Represents theoretical exact dimension or dimension target

MIN: Minimum dimension specified.

MAX: Maximum dimension specified.

REF: Reference. Represents dimension for reference use only. This value is not a device specification.

TYP: Typical. Provided as a general value. This value is not a device specification.

2. Dimensions in Millimeters.

3. Drawing not to scale.

4. These dimensions do not include mold flash or protrusions. Mold flash or protrusions shall not exceed 0.15mm.