

TABLE OF CONTENTS

Description of Terminology.....	2
Structural Drawing	2
Reliability Test and Measuring Method	2
Handling Precautions	3
Super Bright LED Light Bar Module	
Description of Part Number	4
Characteristics by Color	4
LED Light Bar Module Product Line	4-7
Super Bright LED Numeric Display (Seven Segment Display)	
Description of Part Number	8
Characteristics by Color	8
7.5mm Type	9
10.0mm Type	10-12
15.0mm Type	13
25.0mm Type	14
Bi-Color LED Numeric Display.....	15
Alpha Numeric LED Display	16
Index by Part Number	17-19

DESCRIPTION OF TERMINOLOGY

	ITEMS	SYMBOLS	DEFINITION	UNIT
Absolute Max. Ratings	Power dissipation	(Pd)	Power dissipated by forward current and forward voltage	(mW)
	Forward current	(If)	Current from anode to cathode	(mA)
	Peak forward current	(IfM)	Forward peak current driven during pulse lighting	(mA)
	Current derating	(ΔIf)	Derating over 25°C ambient temperature	(mA/°C)
	Forward voltage	(Vf)	Voltage drop when forward current goes from anode to cathode	(V)
Electro-optical characteristics	Reverse current	(Ir)	Leakage current when bias voltage is applied from cathode to anode	(μA)
	Luminous intensity	(Iv)	Flux in lumens per unit of solid angle on optical axis	(mcd)
	Peak wavelength	(λp)	Wavelength at which radiant intensity becomes greatest	(nm)
	Spectral line half width	(Δλ)	Wavelength range in which radiant intensity becomes more than 50% of its peak value	(nm)

www.DataSheet4U.com

RELIABILITY TEST AND MEASURING METHOD

■ Items to be Guaranteed for LEDs

TEST ITEM	STANDARDS	TEST CONDITION	SAMPLE SIZE
Operating Endurance Test	JIS C 7035 Added documents	Ta=25°C, If=Maximum Rated Current, t=1000 Hrs.	25
Resistance to Soldering Heat	JIS C 7021 A-1	260±5°C, 10±1 sec., 3mm from package base	25
Temperature Cycling	JIS C 7021 A-4	-30°C (30 min) to normal temperature (15 min) to +100°C (30 min) To normal temperature (15 min) 5 cycles	25
Humidity (Steady State)	JIS C 7021 B-11	Ta=60±2°C, RH=90±5%, t=1000Hr	25
High Temperature (Storage)	JIS C 7021 B-10	Ta=100±2°C, t=1000Hr	25
Low Temperature (Storage)	JIS C 7021 A-12	Ta=30±2°C, t=1000Hr	25
Lead Tension	JIS C 7021 A-11	*1kg/10 sec. one time (thin lead: 0.5kg)	10
Vibration Fatigue	JIS C 7021 A-10	10G, 100 to 2000Hz sweep for 20 min., 2 hours for directions X, Y and Z	10

■ Measuring Method

Luminous Intensity (Iv)

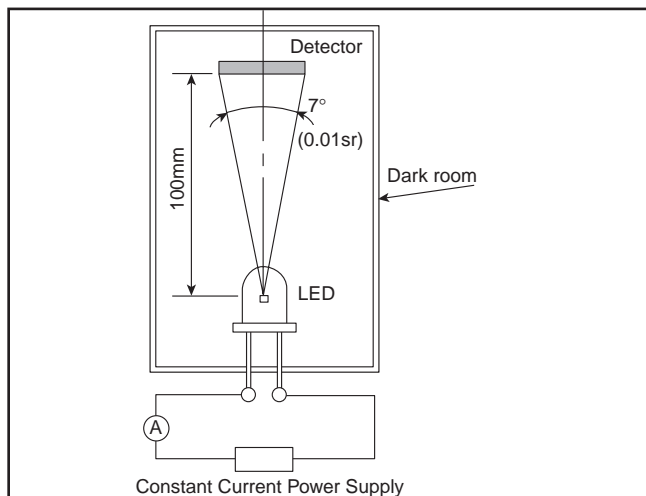

■ Structural Drawing for Numeric Display

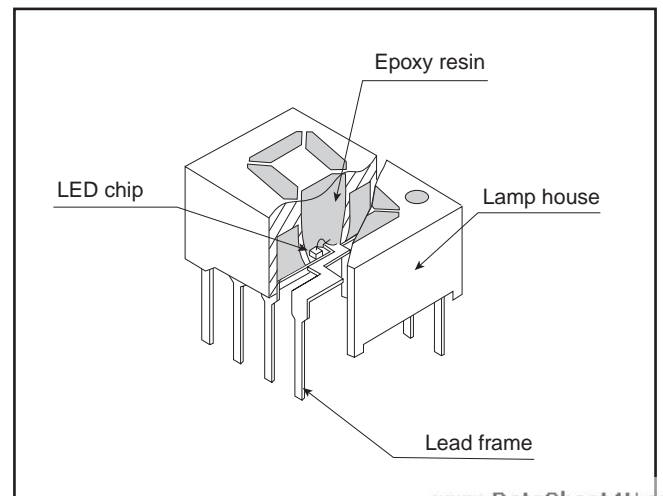

www.DataSheet4U.com

HANDLING PRECAUTIONS

■ Soldering Conditions

Please refer to each product to see if it's compatible with lead-free soldering.

Conventional Soldering Conditions

SOLDERING IRON	DIP SOLDERING	REFLOW SOLDERING
Iron Tip Temperature: 300°C Max. (30W Max.) Soldering Time: 3 Seconds Max. Location: At least 3.0mm away from resin	Pre-heat: 80°C Max. / 60 sec. Max. (Resin surface temperature) Bath Temperature: 260°C Max. Dipping Time: 5 sec. Max. Position: At least 3.0mm away from resin body	Not recommended

www.DataSheet4U.com

Lead-Free Soldering Conditions

SOLDERING IRON	DIP SOLDERING	REFLOW SOLDERING
Iron Tip Temperature: 400°C Max. Soldering Iron: 30W Max. Soldering Time: 3 Seconds Max. Position: At least 2.0mm away from resin	Pre-heat: 100°C Max. / 60 seconds Max. (Resin surface temperature) Bath Temperature: 265°C Max. Dipping time: 5 sec. Max. Position: At least 2.0mm away from resin body	Not recommended

■ Cleaning

Residual solder or flux left on the LED housing could reduce intensity and could affect the optical characteristics. Excess flux can be removed by the following chemical method:

- Cleaning solvents (dipping time: 3 minutes maximum at normal temperature)
 - Ethyl alcohol
 - Isopropyl alcohol
 - Pure water (after cleaning, the water must be removed by drying)
 - Drying condition: 90°C max., 30 sec. max. and 4 times max.
- The effect of ultrasonic cleaning on the LED resin body depends on such factors as the oscillator output, size of PCB and LED mounting method. Ultrasonic cleaning is strongly recommended after confirming that there are no problems.
 - Ultrasonic wave frequency: 28 kHz or 40 kHz
 - Output: 20 W/l
- The solvent for freon equivalent (recommended after confirming that there are no problems).
 - AK-225AES
 - Clean through
 - Pine alpha ST-100S

Chemicals	Freon substitute detergent
Ethyl alcohol	AK225AES
Isopropyl alcohol	Clean through 705H
Pure water	Pine alpha ST-100S

* DIP Soldering and cleaning is not recommended for Alpha-Numeric (AAR121 and AAA121) LED displays. www.DataSheet4U.com

SUPER BRIGHT LED LIGHT BAR MODULE

Stanley's MU series of super-bright LED light bar modules can be selected from a wide variety of configurations and colors to suit a broad range of requirements. By using front mask patterns, including letters, numbers and even graphics, this series is usable for a myriad of display applications.

Description of Part Number

MU 02 - 2201

Shape Code Emitted color Suffix
 2.Red 3.Orange 4.Yellow 5.Green / Pure Green

Characteristics by Color

Ta=25°C

Part No.	Material Emitted Color	Absolute Maximum Ratings						Electro-Optical Characteristics							
		Forward Current	Peak Forward Current	Reverse Voltage	Operating Temperature	Storage Temperature	Derating	Forward Voltage			Reverse Current		Wavelength		
		IF × 1	IFM × 2	VR	Topr × 3	Tstg × 4	ΔIF	TYP.	MAX.	IF	MAX.	VR	Peak λp TYP.	Spectral Line Half Width Δλ TYP.	IF
2□□□	GaAlAs (Red)	30	60	4	-40~+85	-40~+85	0.40	1.7	2.0	20	100	4	660	30	20
3□□□	GaAsP (Orange)	25	60	4	-40~+85	-40~+85	0.33	2.2	2.5	20	100	4	605	30	20
4□□□	GaP (Yellow)	30	60	4	-40~+85	-40~+85	0.40	2.1	2.5	20	100	4	570	30	20
5□□1	GaP (Pure Green)	25	60	4	-40~+85	-40~+85	0.33	2.2	2.5	20	100	4	555	30	20
5□□2	GaP (Green)	30	60	4	-40~+85	-40~+85	0.40	2.1	2.5	20	100	4	560	30	20
5□□5	GaP (Pure Green)	25	60	4	-40~+85	-40~+85	0.33	2.2	2.5	20	100	4	555	30	20
9□□1	GaAlAs (Red)	30	60	4	-40~+85	-40~+85	0.40	1.7	2.0	20	100	4	660	30	20
	GaP (Pure Green)	25	60	4	-40~+85	-40~+85	0.33	2.2	2.5	20	100	4	555	30	20
9□□2	GaAlAs (Red)	30	60	4	-40~+85	-40~+85	0.40	1.7	2.0	20	100	4	660	30	20
	GaP (Yellow)	30	60	4	-40~+85	-40~+85	0.40	2.1	2.5	20	100	4	570	30	20
9□□3	GaAlAs (Red)	30	60	4	-40~+85	-40~+85	0.40	1.7	2.0	20	100	4	660	30	20
	GaAsP (Orange)	25	60	4	-40~+85	-40~+85	0.33	2.2	2.5	20	100	4	605	30	20
Units		mA	mA	V	°C	°C	mA/°C	V	mA	μA	V	nm	nm	mA	



✦ 1 : MU91, MU92 and MU93 series are all 30 mA.

✦ 2 : $t_w \leq 2$ msec, duty $\leq 1/5$ However, for the MU91, MU92 and MU93 series, 300 mA for red and 100 mA for yellow, orange and pure green ($t_w \leq 1$ msec, duty $\leq 1/20$)

✦ 3 ✦ 4 : For MU91, MU92 and MU93 series, the temperature range is -30°C to +85°C.

Characteristics by Shape

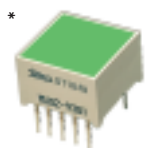
Ta=25°C

Shape	Part No.	Emitted Color	Resin Color	Light Emitting Surface (Outer Size)	No. of Chips	Absolute Max. Rating	Electro-Optical Characteristics			fig.			
						Power Dissipation Pd	Luminous Intensity Iv		IF				
							MIN.	TYP.					
* 	MU02-2201	Red	Red	14 x 14 (15 x 15)	4	240	20	42	20	1			
	MU02-2205		Milky White		4	240	20	42	20				
	MU02-3201	Orange	Orange		4	250	10	20	20				
	MU02-3205		Milky White		4	250	10	20	20				
	MU02-4201	Yellow	Yellow		4	300	20	42	20				
	MU02-4205		Milky White		4	300	20	42	20				
	MU02-5201	Pure Green	Green		4	250	10	20	20				
	MU02-5202	Green	Green		4	300	15	32	20				
	MU02-5205	Pure Green	Milky White		4	250	10	20	20				
	MU02-9301	Red	Green		Green	4	240	8	12		20	2	
MU02-9305	Pure Green	4		250		8	12	20					
* 	MU03-2201	Red	Red	6 x 9 (7 x 10)	2	120	10	20	20	3			
	MU03-2205		Milky White		2	120	10	20	20				
	MU03-3201	Orange	Orange		2	125	5	10	20				
	MU03-3205		Milky White		2	125	5	10	20				
	MU03-4201	Yellow	Yellow		2	150	10	20	20				
	MU03-4205		Milky White		2	150	10	20	20				
	MU03-5201	Pure Green	Green		2	125	3	7	20				
	MU03-5202	Green	Green		2	150	8	16	20				
	MU03-5205	Pure Green	Milky White		2	125	5	10	20				
	MU03-9201	Red	Milky White		Milky White	1	60	5	7		20		
	MU03-9205	Pure Green				1	62.5	3	4		20		
	Units					mm	pcs	mW	mcd		mA		

* Lead-free soldering compatible product

Package Dimensions

unit : mm

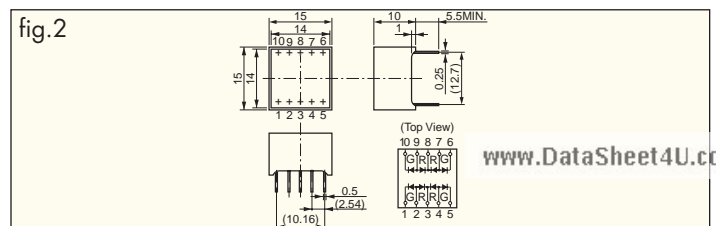
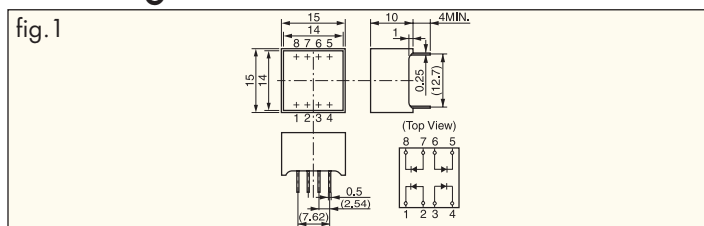

Tolerance : ±0.25mm



SUPER BRIGHT LED LIGHT BAR MODULE

Characteristics by Shape

Ta=25°C

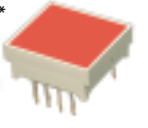
Shape	Part No.	Emitted Color	Resin Color	Light Emitting Surface (Outer Size)	No. of Chips	Absolute Max. Rating Power Dissipation Pd	Electro-Optical Characteristics			fig.	
							Luminous Intensity Iv		If		
							MIN.	TYP.			
	MU04-2101	Red	Red	6X19 (7X20)	3	180	15	32	20	4	
	MU04-2105		Milky White		3	180	15	32	20		
	MU04-3101	Orange	Orange		3	190	8	16	20		
	MU04-3105		Milky White		3	190	8	16	20		
	MU04-4101	Yellow	Yellow		3	225	15	32	20		
	MU04-4105		Milky White		3	225	15	32	20		
	MU04-5101	Pure Green	Green		3	190	8	16	20		
	MU04-5102	Green	Green		3	225	10	20	20		
	MU04-5105	Pure Green	Milky White		3	190	8	16	20		
	MU07-2101	Red	Red	6X29 (7X30)	5	300	20	40	20	5	
	MU07-3101	Orange	Orange		5	320	10	20	20		
	MU07-4101	Yellow	Yellow		5	375	20	40	20		
	MU07-5101	Pure Green	Green		5	320	10	20	20		
		MU08-2201	Red		Red	14X16 (15X17)	4	240	20		40
MU08-3201		Orange	Orange	4	250		10	20	20		
MU08-4201		Yellow	Yellow	4	300		20	40	20		
MU08-5201		Pure Green	Green	4	250		10	20	20		
MU08-9301		Red	Green	4	240		8	12	20	20	7
MU08-9301		Pure Green		4	250		8	12	20	20	
				Units	mm	pcs	mW	mcd	mA		

* Lead-free soldering compatible product

Package Dimensions unit : mm

Tolerance : ±0.25mm

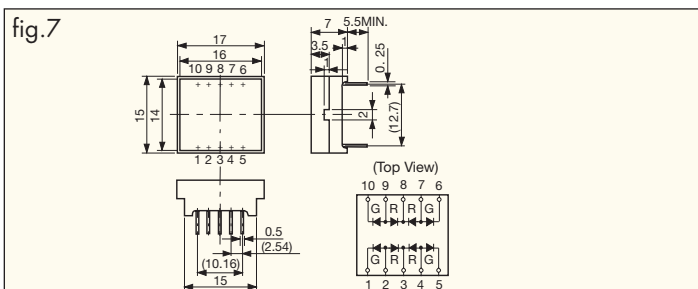
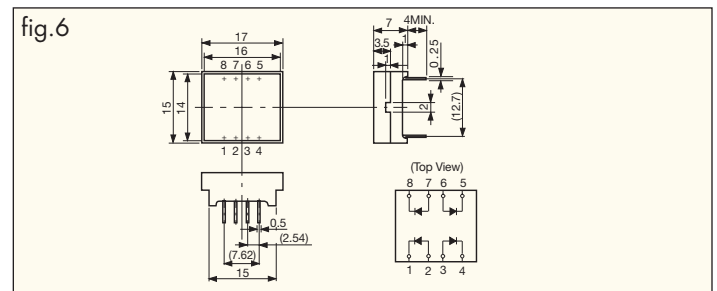
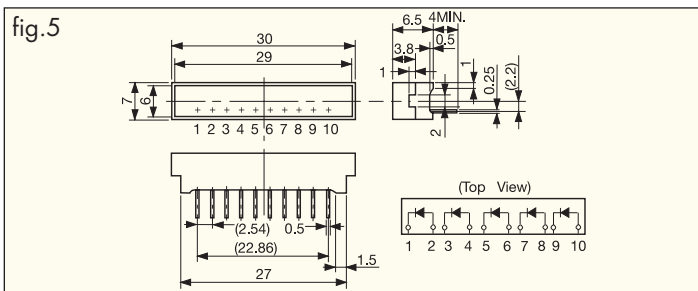
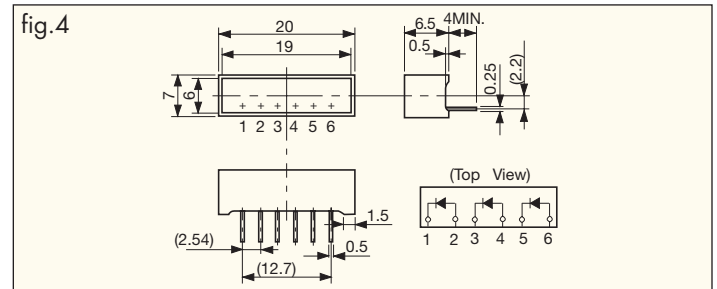
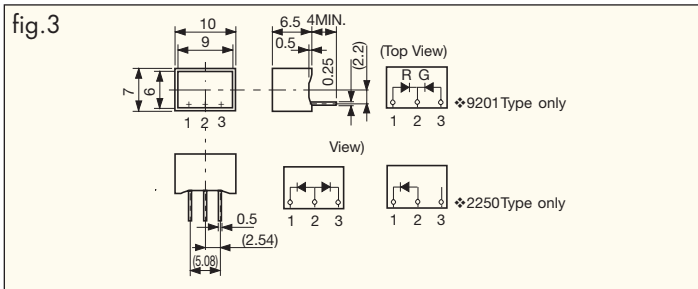

SUPER BRIGHT LED LIGHT BAR MODULE

Characteristics by Shape

Ta=25°C

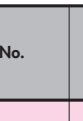
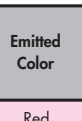
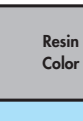
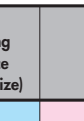
Shape	Part No.	Emitted Color	Resin Color	Light Emitting Surface (Outer Size)	No. of Chips	Absolute Max. Rating		Electro-Optical Characteristics			fig.
						Power Dissipation Pd	Luminous Intensity		Iv		
							MIN.	TYP.		If	
* 	MU09-9101	Red	Milky White	φ 6.4 (φ 7)	1	60	4	8	20	8	
		Pure Green			2	125	4	6	20		
	MU09-9102	Red	Milky White		1	60	4	8	20		
		Yellow			2	150	6	12	20		
	MU09-9103	Red	Milky White		1	60	4	8	20		
		Orange			2	125	4	8	20		
* 	MU11-2201	Red	Red	4.6X9.5 (5.6X10.5)	2	120	10	20	20	9	
	MU11-3201	Orange	Orange		2	125	5	10	20		
	MU11-4201	Yellow	Yellow		2	150	10	20	20		
	MU11-5201	Pure Green	Green		2	125	5	10	20		
* 	MU13-9101	Red	Milky White	9X9 (10.1X10.1)	1	60	6	12	20	10	
		Pure Green			5	310	7	14	20		
	MU13-9102	Red	Milky White		1	60	6	12	20		
Yellow	5	375		20	40	20					
* 	MU16-2101	Red	Red	4X12 (5X13)	2	120	8	16	20	11	
	MU16-2105		Milky White		2	120	8	16	20		
	MU16-3101	Orange	Orange		2	125	6	12	20		
	MU16-3105		Milky White		2	125	6	12	20		
	MU16-4101	Yellow	Yellow		2	150	8	16	20		
	MU16-4105		Milky White		2	150	8	16	20		
	MU16-5101	Pure Green	Green		2	125	4	8	20		
	MU16-5105		Milky White		2	125	4	8	20		
* 	MU17-2101	Red	Red	4X19 (5X20)	3	180	12	24	20	12	
	MU17-2105		Milky White		3	180	12	24	20		
	MU17-3101	Orange	Orange		3	190	9	18	20		
	MU17-3105		Milky White		3	190	9	18	20		
	MU17-4101	Yellow	Yellow		3	225	12	24	20		
	MU17-4105		Milky White		3	225	12	24	20		
	MU17-5101	Pure Green	Green		3	190	5	10	20		
	MU17-5105		Milky White		3	190	5	10	20		
Units				mm	pcs	mW	mcd		mA		

* Lead-free soldering compatible product

Package Dimensions unit : mm

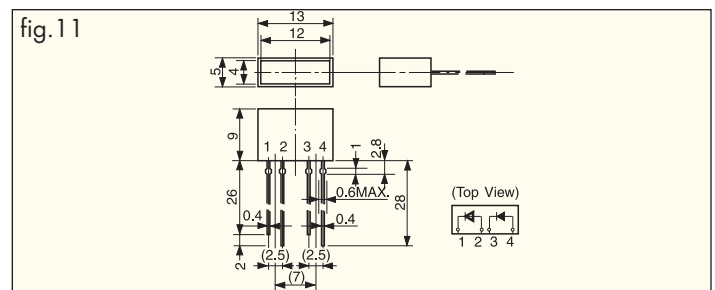
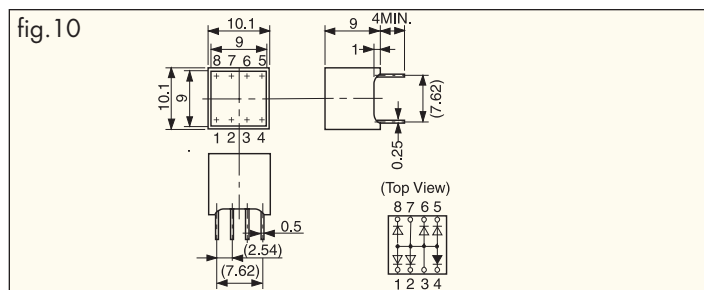
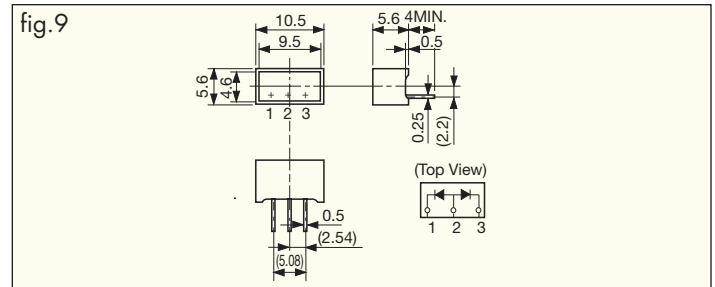
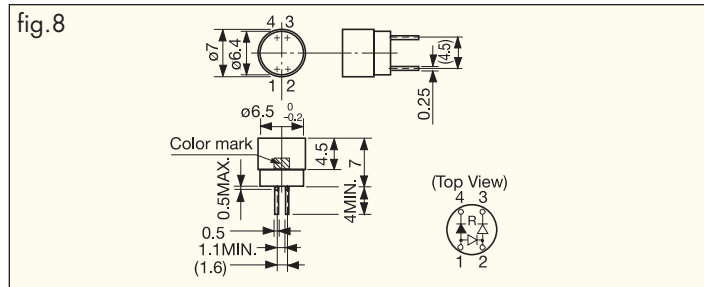

Tolerance : ±0.25mm



SUPER BRIGHT LED LIGHT BAR MODULE

Characteristics by Shape

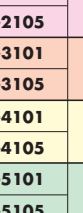
Ta=25°C

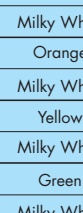
Shape	Part No.	Emitted Color	Resin Color	Light Emitting Surface (Outer Size)	No. of Chips	Absolute Max. Rating Power Dissipation Pd	Electro-Optical Characteristics			fig.
							Luminous Intensity Iv			
							MIN.	TYP.	If	
	MU20-2101	Red	Red	5X9 (6X10)	1	60	4	8	20	13
	MU20-2105		Milky White		1	60	4	8	20	
	MU20-3101	Orange	Orange		1	62.50	3	6	20	
	MU20-3105		Milky White		1	62.50	3	6	20	
	MU20-4101	Yellow	Yellow		1	75	4	8	20	
	MU20-4105		Milky White		1	75	4	8	20	
	MU20-5101	Pure Green	Green		1	62.50	2	4	20	
	MU20-5105		Milky White		1	62.50	2	4	20	
	MU91-2001	Red	Red	6X6 (6X6)	1	60	3	6	20	14
	MU91-3001	Orange	Orange		1	75	3	6	20	
	MU91-4001	Yellow	Yellow		1	75	3	6	20	
	MU91-5001	Pure Green	Green		1	75	1.2	2.4	20	
	MU92-2001	Red	Red	9X5 (9X5)	1	60	3	6	20	15
	MU92-3001	Orange	Orange		1	75	3	6	20	
	MU92-4001	Yellow	Yellow		1	75	3	6	20	
	MU92-5001	Pure Green	Green		1	75	1.2	2.4	20	
	MU93-2001	Red	Red	10X10 (10X10)	1	60	4	8	20	16
	MU93-3001	Orange	Orange		1	75	4	8	20	
	MU93-4001	Yellow	Yellow		1	75	4	8	20	
	MU93-5001	Pure Green	Green		1	75	1.5	3	20	
Units				mm	pcs	mW	mcd		mA	

* Lead-free soldering compatible product

Package Dimensions unit : mm

Tolerance : ±0.25mm

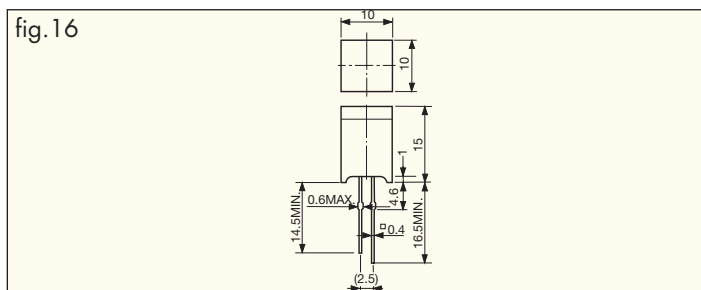
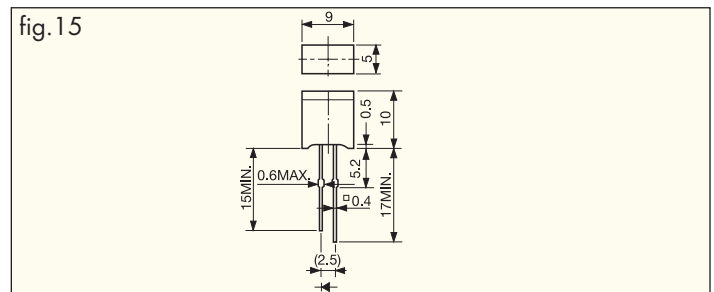
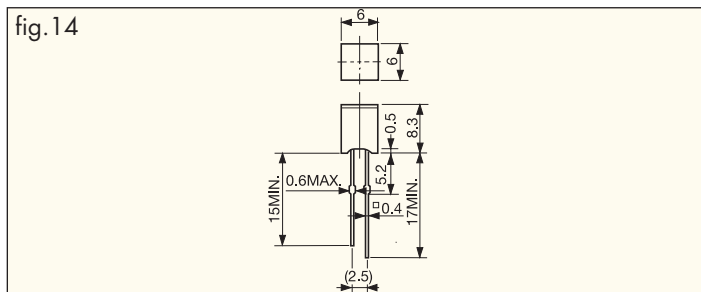
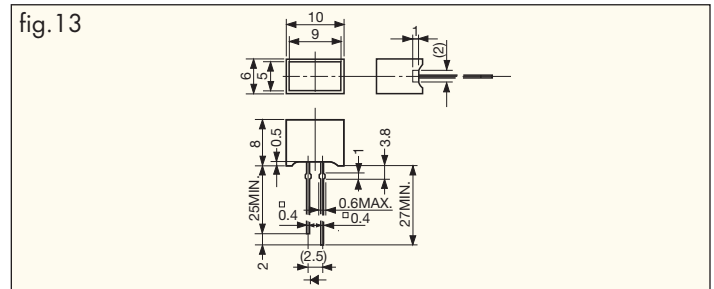
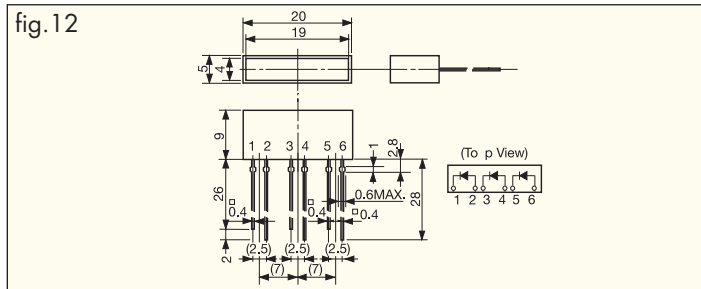

SUPER BRIGHT LED NUMERIC DISPLAY (SEVEN SEGMENT DISPLAY)

Stanley's Numeric Displays which incorporate super-bright LEDs produce vivid, brilliant displays. Available colors are red, pure green, green, yellow and orange. Display types include segment type (character heights 7.5mm to 25mm) and the alpha-numeric type (character heights 25mm and 51mm). These are suitable for dynamic drive due to the low-current drive characteristics.

Description of Part Number

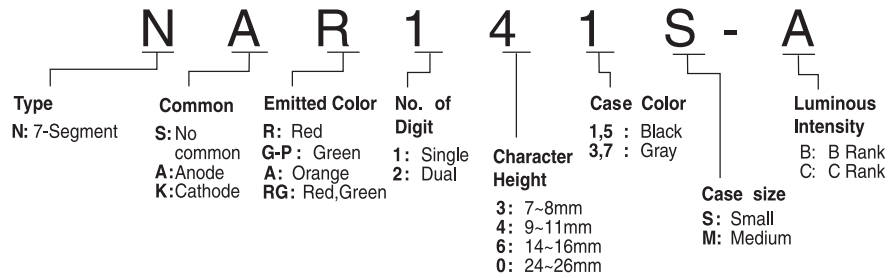

Characteristics by Color

Ta=25°C



Size	Part No.	Material Emitted Color	Chip / Segment	Absolute Maximum Rating						Electro-Optical Characteristics						Derating ΔIF	
				Power Dissipation Pd	Forward Current IF	Peak Forward Current IFM	Reverse Voltage TR	Operating Temp Topr	Storage Temp Tstg	Forward Voltage VF			Reverse Current IR		Wavelength λp		
										TYP.	MAX.	IF	MAX.	VR	TYP		IF
7.5	N□R13□	GaP(Red)	1	37.5	15	60	4	-30~+85	-30~+85	2.0	2.5	10	100	4	700	10	0.25
	N□R13□S,ME	GaAlAs(Red)	1	40	20	80	4	-30~+85	-30~+85	1.7	2.0	10	100	4	660	10	0.33
	N□G13□P,SP,MP	GaP(Green)	1	48	20	80	4	-30~+85	-30~+85	2.0	2.4	10	100	4	565	10	0.33
	N□A13□,S,M	GaAsP(Orange)	1	48	20	80	4	-30~+85	-30~+85	2.0	2.4	10	100	4	605	10	0.33
10	N□R14□,N□R24	GaAlAs(Red)	1	60	30	120	4	-40~+85	-40~+85	1.7	2.0	20	100	4	660	20	0.41
	N□R14□S	GaAlAs(Red)	1	40	20	80	4	-30~+85	-30~+85	1.7	2.0	10	100	4	660	10	0.33
	N□G14□P,N□G24P	GaP(Green)	1	63	25	100	4	-40~+85	-40~+85	2.2	2.5	20	100	4	565	20	0.34
	N□G14□SP	GaP(Green)	1	48	20	80	4	-40~+85	-30~+85	2.0	2.4	10	100	4	565	10	0.33
	N□A14□,N□A24□	GaAsP(Orange)	1	63	25	100	4	-40~+85	-40~+85	2.2	2.5	20	100	4	605	20	0.34
	N□A14□S	GaAsP(Orange)	1	48	20	80	4	-30~+85	-30~+85	2.0	2.4	10	100	4	605	10	0.33
	NARG14□	GaAlAs(Red)	1	36	15	70	4	-30~+70	-30~+80	1.7	2.0	10	20	4	660	10	0.22
		GaP(Green)								2.0	2.4	10			570	10	
15	N□R16□,N□R26□	GaAlAs(Red)	1	60	30	120	4	-40~+85	-40~+85	1.7	2.0	20	100	4	660	20	0.41
	N□G16□P,N□G26□P	GaP(Green)	1	63	25	100	4	-40~+85	-40~+85	2.2	2.5	20	100	4	565	20	0.34
	N□A16□,N□A26□	GaAsP(Orange)	1	63	25	100	4	-40~+85	-40~+85	2.2	2.5	20	100	4	605	20	0.34
	NARG16□	GaAlAs(Red)	1	36	15	70	4	-30~+70	-30~+80	1.7	2.0	10	20	4	660	10	0.22
GaP(Green)									2.0	2.4	10			570	10		
25	N□R10□	GaAlAs(Red)	2	120	30	120	4	-20~+85	-20~+85	3.4	4.0	20	100	8	660	20	0.41
	N□G10□P	GaP(Green)	2	126	25	100	4	-20~+85	-20~+85	4.4	5.0	20	100	8	565	20	0.34
	N□A10□	GaAsP(Orange)	2	126	25	100	4	-20~+85	-20~+85	4.4	5.0	20	100	8	605	20	0.34
	NARG10□	GaAlAs(Red)	2	80	20	40	4	-30~+70	-30~+80	3.4	4.0	10	100	4	660	10	0.33
GaP(Green)		2	96	20	40	4			4.0	4.8	10			570	10		
mm	Units			mW	mA	mA	V	°C		V	mA	μA	V	nm	mA	mA/°C	

- Number of chips per segment
- Ratings and specifications are for one segment
- When both colors of a bi-color LED are driven simultaneously, the rating of NARG types are the total of the Pd, IF and IFM values.
- ❖ 1 : NARG 10□ type in dynamic drive has a duty cycle of 1/2 and f=500Hz and the others have a duty cycle of 1/5 and f=1 kHz.

SUPER BRIGHT LED NUMERIC DISPLAY

7.5mm Type

Ta=25°C

Case Size (WXH)	Shape	Part No.		Emitted Color	Luminous Intensity Iv					fig.
		Anode Common	Cathode Common		MIN.	Rank B TYP.	Rank C MIN.	Rank C TYP.	I _F	
7.0 X 11.0	Arrow feather type 	NAR131S/133S	NKR131S/133S	Red	1.4	2.8	2.8	5.6	10	1
		NAG131SP/133SP	NKG131SP/133SP	Green	1	2	—	—	10	
		NAA131S/133S	NKA131S/133S	Orange	0.6	1.2	—	—	10	
10.0 X 15.0	Arrow feather type 	NAG131ME/133ME	NKR131ME/133ME	Red	1.2	2.4	—	—	10	2
		NAG131MP/133MP	NKG131MP/133MP	Green	0.6	1.2	—	—	10	
		NAA131M/133M	NKA131M/133M	Orange	0.8	1.6	—	—	10	
10.0 X 19.0	Arrow feather type 	NAR131/133	NKR131/133	Red	0.3	0.6	—	—	10	3
		NAG131P/133P	NKG131P/133P	Green	0.6	1.2	—	—	10	
		NAA131/133	NKA131/133	Orange	0.8	1.6	—	—	10	
mm		Units			mcd					mA

Package Dimensions unit : mm

Tolerance : ±0.25mm

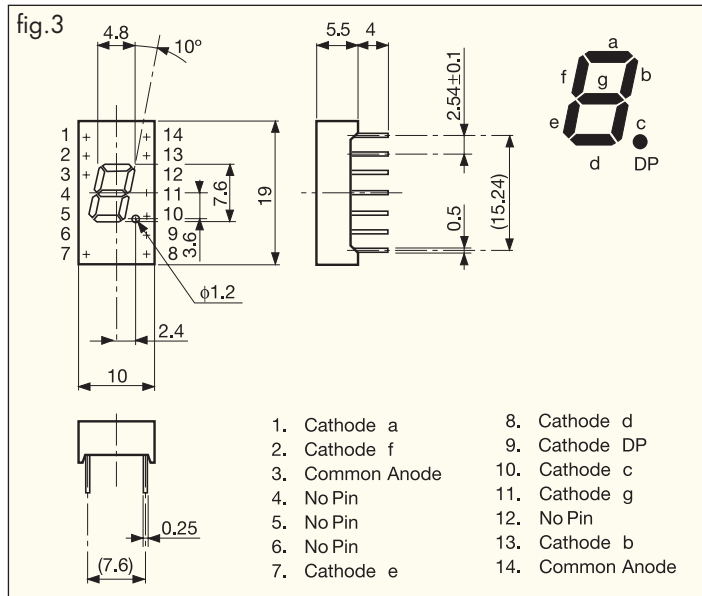
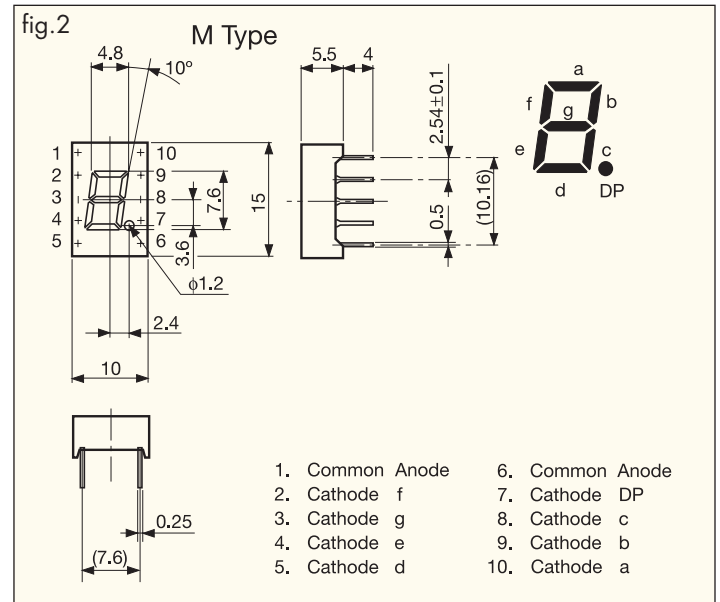
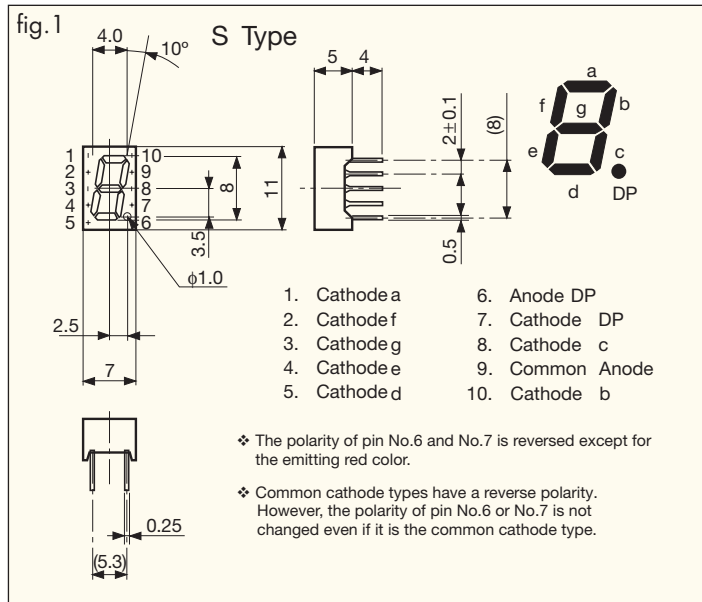



● Common cathode types shown in fig. 2 and 3 have a reverse polarity.

SUPER BRIGHT LED NUMERIC DISPLAY

10mm Type

Ta=25°C

Case Size (WXH)	Shape	Part No.	Emitted Color	Luminous Intensity I _v					I _F	fig.
				MIN.	Rank B	TYP.	MIN.	Rank C		
12.5 X 19.0	Square shape type 	NSR141/143	Red	4	8	8	8	11	20	4
		NSG141P/143P	Green	1	2	—	—	—	20	
		NSA141/143	Orange	3	6	—	—	—	20	
12.5 X 19.0	Arrow feather type 	NSR145/147	Red	3.2	6.4	6.4	6.4	8.8	20	5
		NSG145P/147P	Green	0.8	1.6	—	—	—	20	
		NSA145/147	Orange	2.4	4.8	—	—	—	20	
mm		Units		mcd					mA	

www.DataSheet4U.com

Package Dimensions

unit : mm

Tolerance : ±0.25mm

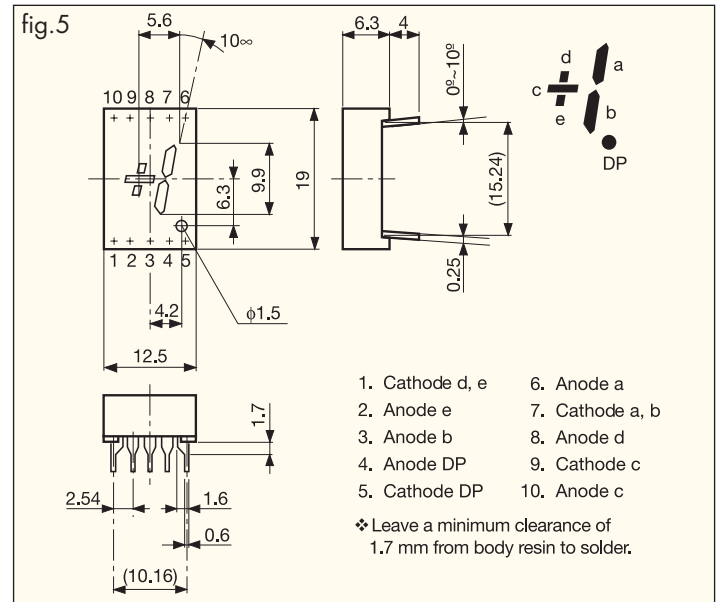
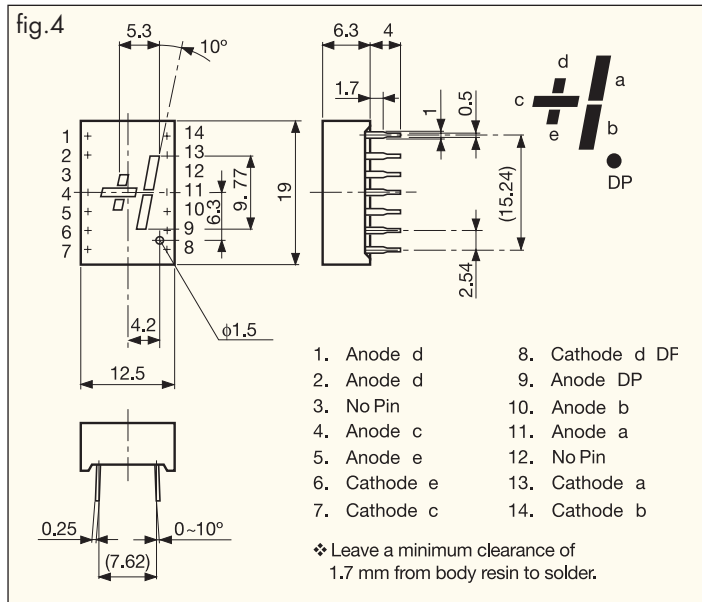

SUPER BRIGHT LED NUMERIC DISPLAY

10mm Type

Ta=25°C

Case Size (WXH)	Shape	Part No.		Emitted Color	Luminous Intensity Iv					fig.
		Anode Common	Cathode Common		MIN.	Rank B TYP.	MIN.	Rank C TYP.	If	
9.6 X 13.0	Arrow feather type	NAR141S/143S	NKR141S/143S	Red	1.6	3.2	3.2	6.4	10	6
		NAG141SP/143SP	NKG141SP/143SP	Green	0.6	1.2	—	—	10	
		NAA141S/143S	NKA141S/143S	Orange	0.8	1.6	—	—	10	
12.5 X 19.0	Square shape type	NAR141/143	NKR141/143	Red	4	8	8	11	20	7
		NAG141P/143P	NKG141P/143P	Green	1	2	—	—	20	
		NAA141/143	NKA141/143	Orange	3	6	—	—	20	
12.5 X 19.0	Arrow feather type	NAR145/147	NKR145/147	Red	3.2	6.4	6.4	8.8	20	8
		NAG145P/147P	NKG145P/147P	Green	0.8	1.6	—	—	20	
		NAA145/147	NKA145/147	Orange	2.4	4.8	—	—	20	
mm		Units			mcd					mA

Package Dimensions unit : mm

Tolerance : ±0.25mm

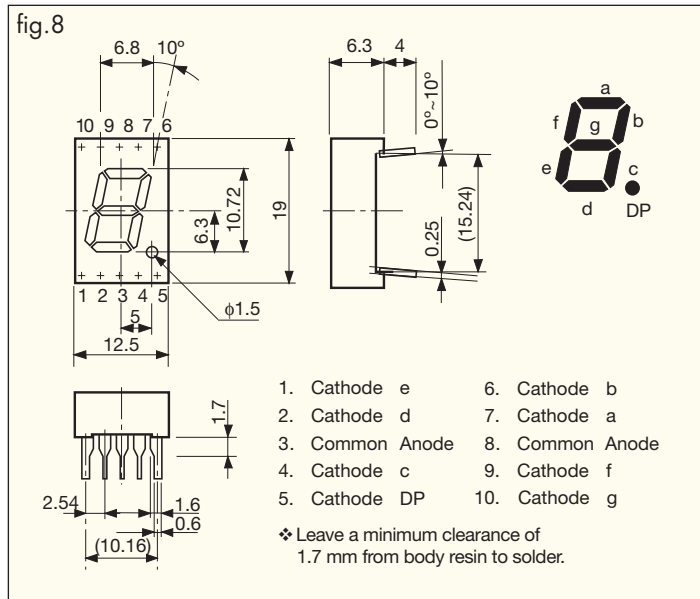
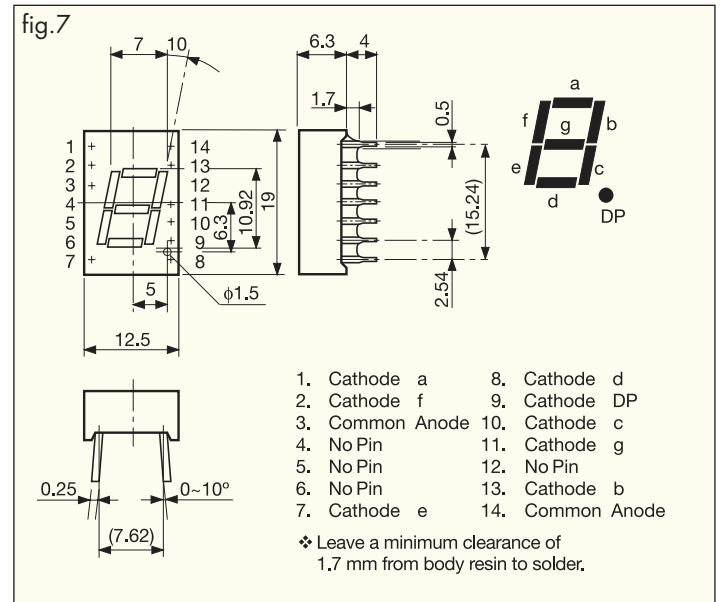
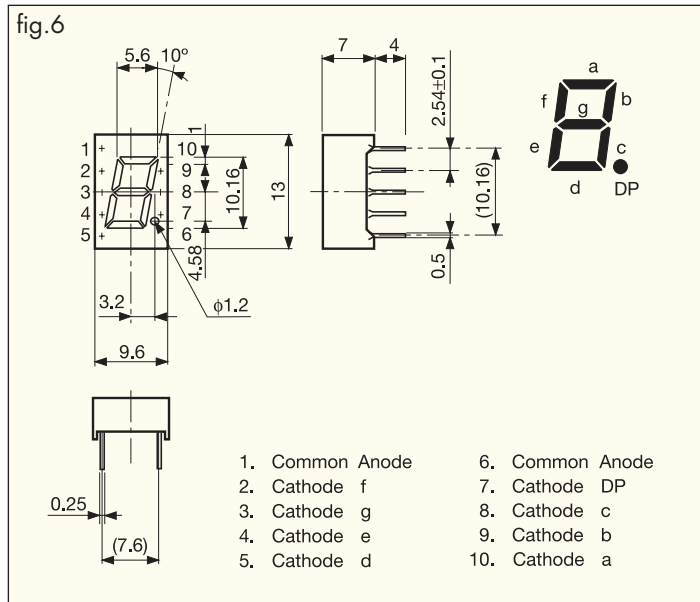

● Common cathode types shown in fig. 6, 7, and 8 have a reverse polarity.

SUPER BRIGHT LED NUMERIC DISPLAY

10mm Type

Ta=25°C

Case Size (WXH)	Shape	Part No.		Emitted Color	Luminous Intensity Iv					fig.
		Anode Common	Cathode Common		Rank B		Rank C		I _F	
					MIN.	TYP.	MIN.	TYP.		
25.2 X 19.0	Square shape type	NAR241/243	NKR241/243	Red	4	8	8	11	20	9
		NAG241P/243P	NKG241P/243P	Green	1	2	—	—	20	
		NAA241/243	NKA241/243	Orange	3	6	—	—	20	
25.2 X 19.0	Arrow feather type	NAR245/247	NKR245/247	Red	3.2	6.4	6.4	8.8	20	10
		NAG245P/247P	NKG245P/247P	Green	0.8	1.6	—	—	20	
		NAA245/247	NKA245/247	Orange	2.4	4.8	—	—	20	
mm		Units			mcd					mA

www.DataSheet4U.com

Package Dimensions

unit : mm

Tolerance : ±0.25mm

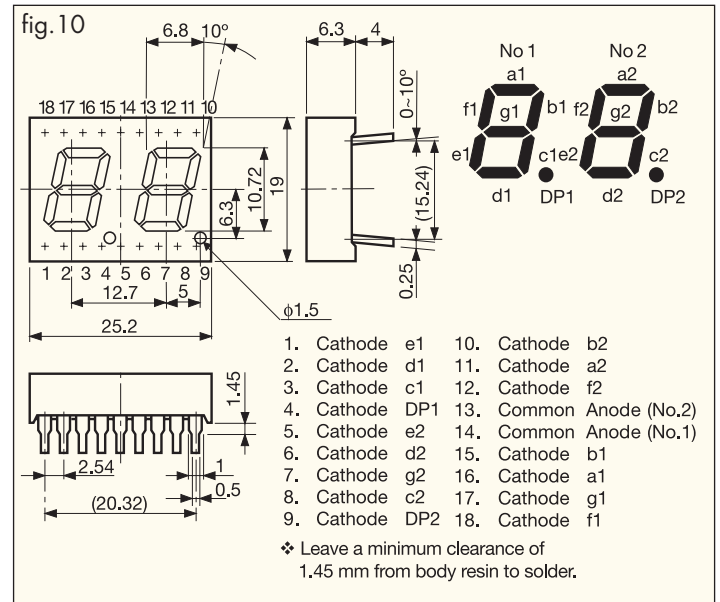
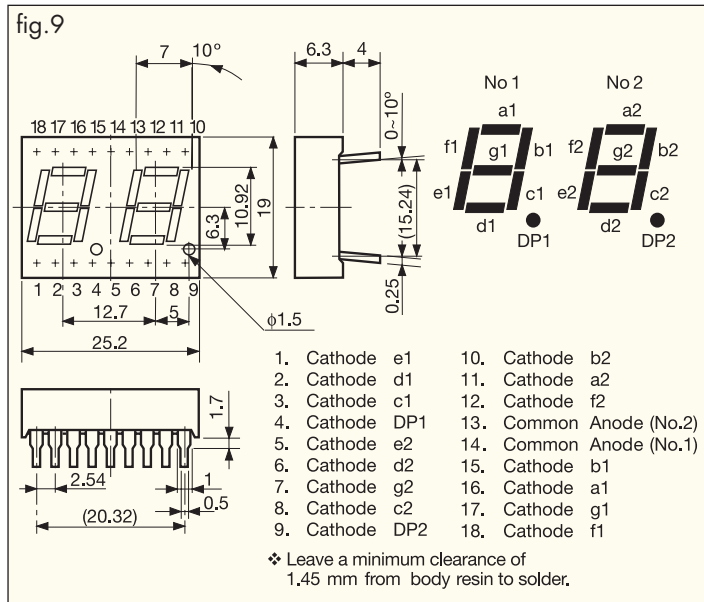

• Common cathode types shown in fig. 9 and 10 have a reverse polarity.

SUPER BRIGHT LED NUMERIC DISPLAY

15mm Type

Ta=25°C

Case Size (WXH)	Shape	Part No.		Emitted Color	Luminous Intensity Iv					fig.
		Anode Common	Cathode Common		MIN.	Rank B TYP.	Rank C MIN.	Rank C TYP.	I _F	
12.5 X 19.0	Arrow feather type	NSR161/163		Red	6	12	12	15	20	11
		NSG161P/163P		Green	2	4	—	—	20	
		NSA161/163		Orange	4	8	—	—	20	
12.5 X 19.0	Arrow feather type	NAR161/163	NKR161/163	Red	6	12	12	15	20	12
		NAG161P/163P	NKG161P/163P	Green	2	4	—	—	20	
		NAA161/163	NKA161/163	Orange	4	8	—	—	20	
25.2 X 19.0	Arrow feather type	NAR261/263	NKR261/263	Red	6	12	12	15	20	13
		NAG261P/263P	NKG261P/263P	Green	2	4	—	—	20	
		NAA261/263	NKA261/263	Orange	4	8	—	—	20	
mm	Units				mcd					mA

Package Dimensions unit : mm

Tolerance : ±0.25mm

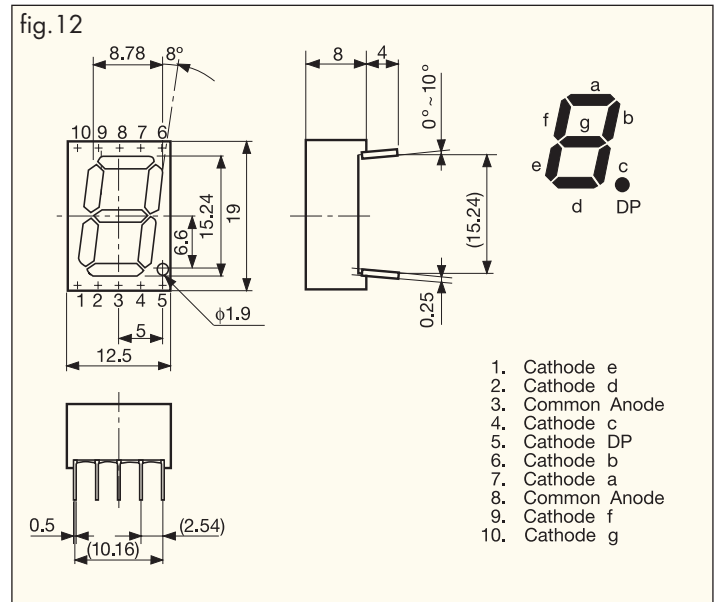
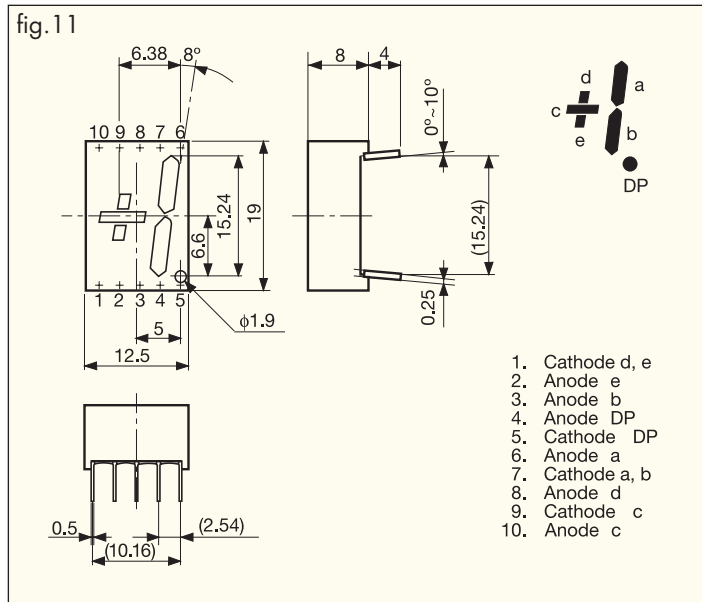

● Common cathode types shown in fig. 12 and 13 have a reverse polarity.

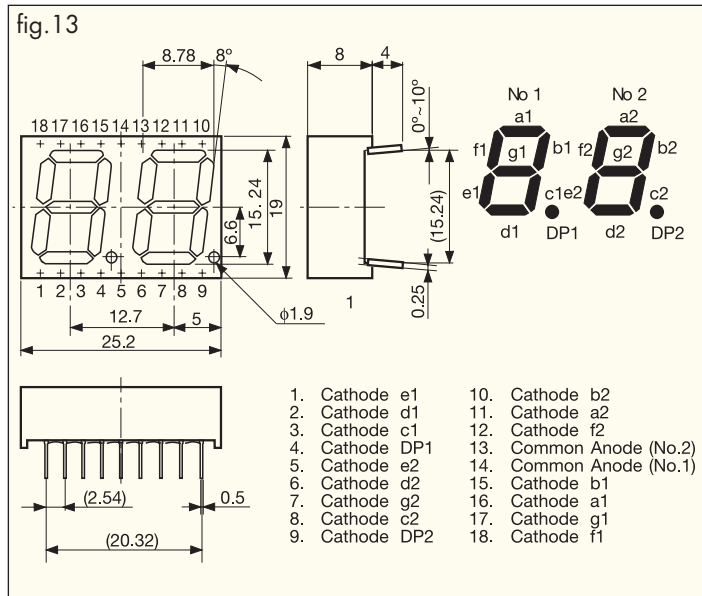

SUPER BRIGHT LED NUMERIC DISPLAY

25mm Type

Ta=25°C

Case Size (WXH)	Shape	Part No.		Emitted Color	Luminous Intensity I _v				fig.
		Anode Common	Cathode Common		Rank B		Rank C		
					MIN.	TYP.	MIN.	TYP.	
22.8 X 33.0	*Square shape type 	NSR101/103		Red	10	20	20	25	20
		NSG101P/103P		Green	4	8	—	—	20
		NSA101/103		Orange	8	16	—	—	20
22.8 X 33.0	*Square shape type 	NAR101/103	NKR101/103	Red	10	20	20	25	20
		NAG101P/103P	NKG101P/103P	Green	4	8	—	—	20
		NAA101/103	NKA101/103	Orange	8	16	—	—	20
22.8 X 33.0	*Arrow feather type 	NAR105/107	NKR105/107	Red	10	20	20	25	20
		NAG105P/107P	NKG105P/107P	Green	4	8	—	—	20
		NAA105/107	NKA105/107	Orange	8	16	—	—	20
mm		Units			mcd				mA

* Lead-free soldering compatible product

Package Dimensions

unit : mm

Tolerance : ±0.25mm

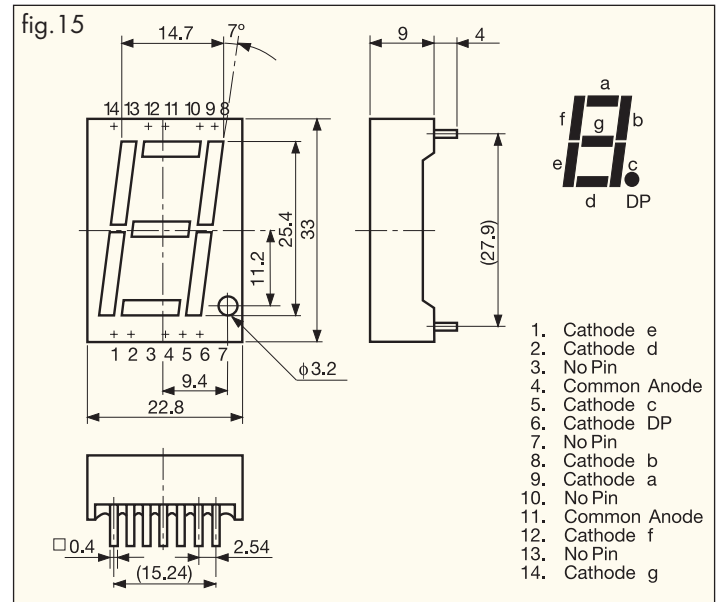
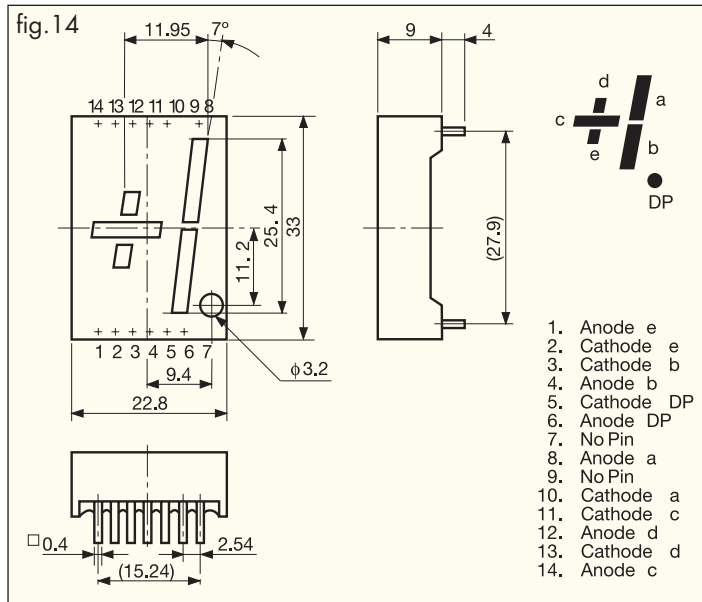

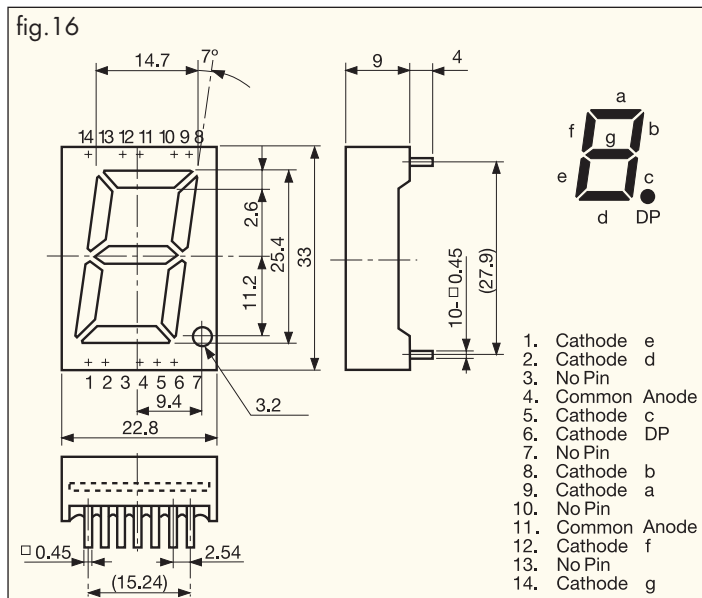

• Common cathode types shown in fig. 15 and 16 have a reverse polarity.



SUPER BRIGHT LED NUMERIC DISPLAY

■ Bi-color LED Numeric Displays 10/15/25mm TYPE

Ta=25°C

Case Size (WXH)	Shape	Part No.		Emitted Color	Luminous Intensity Iv			fig.	
		Anode Common	Cathode Common		MIN.	TYP.	I _F		
10.0 X 19.0	*Arrow feather type 	■	NARG141/143	■	Red	1.2	2.4	10	17
		■	NKRG141/143	■	Green	1.2	2.4	10	
12.5 X 19.0	*Arrow feather type 	■	NARG161/163	■	Red	1.2	2.4	10	18
		■	NKRG161/163	■	Green	1.2	2.4	10	
22.8 X 33.0	*Arrow feather type 	■	NARG105/107	■	Red	2	4	10	19
		■		Green	2	4	10		
mm		Units			mcd		mA		

* Lead-free soldering compatible product

■ Package Dimensions unit : mm

Tolerance : ±0.25mm

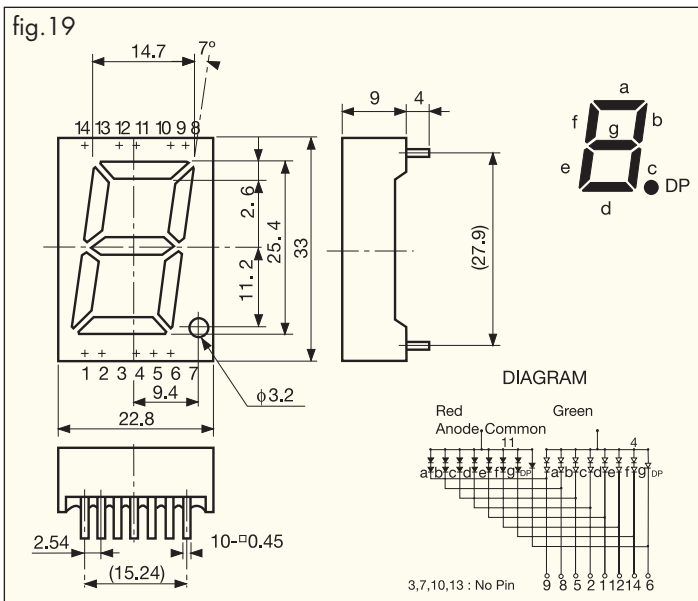
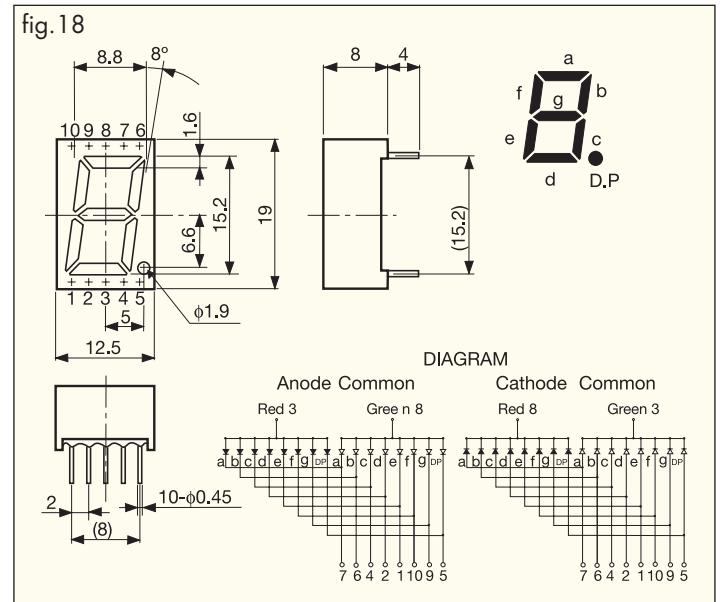
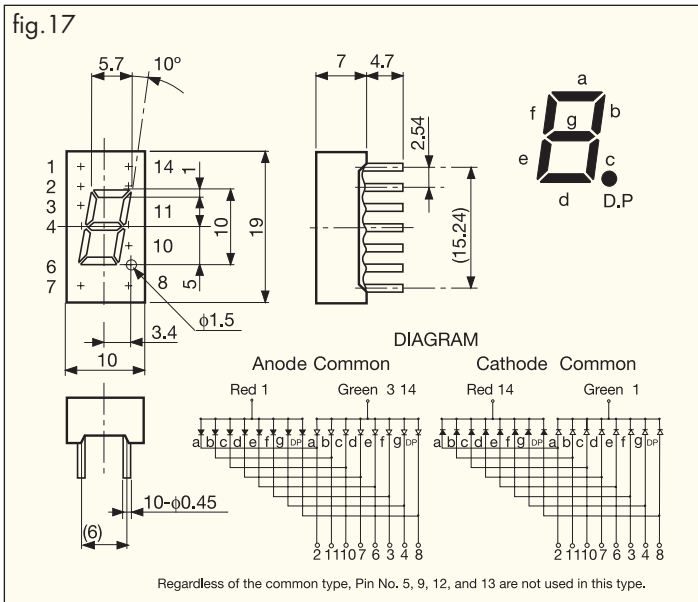

INDEX

PART NUMBER	PAGE
AAA101	16
AAA121	16
AAR101	16
AAR121	16
MU02-2201	4
MU02-2205	4
MU02-3201	4
MU02-3205	4
MU02-4201	4
MU02-4205	4
MU02-5201	4
MU02-5202	4
MU02-5205	4
MU02-9301	4
MU03-2201	4
MU03-2205	4
MU03-3201	4
MU03-3205	4
MU03-4201	4
MU03-4205	4
MU03-5201	4
MU03-5202	4
MU03-5205	4
MU03-9201	4
MU04-2101	5
MU04-2105	5
MU04-3101	5
MU04-3105	5
MU04-4101	5
MU04-4105	5
MU04-5101	5
MU04-5102	5
MU04-5105	5
MU07-2101	5
MU07-3101	5
MU07-4101	5
MU07-5101	5

PART NUMBER	PAGE
MU08-2201	5
MU08-3201	5
MU08-4201	5
MU08-5201	5
MU08-9301	5
MU09-9101	6
MU09-9102	6
MU09-9103	6
MU11-2201	6
MU11-3201	6
MU11-4201	6
MU11-5201	6
MU13-9101	6
MU13-9102	6
MU16-2101	6
MU16-2105	6
MU16-3101	6
MU16-3105	6
MU16-4101	6
MU16-4105	6
MU16-5101	6
MU16-5105	6
MU17-2101	6
MU17-2105	6
MU17-3101	6
MU17-3105	6
MU17-4101	6
MU17-4105	6
MU17-5101	6
MU17-5105	6
MU20-2101	7
MU20-2105	7
MU20-3101	7
MU20-3105	7
MU20-4101	7
MU20-4105	7
MU20-5101	7

PART NUMBER	PAGE
MU20-5105	7
MU91-2001	7
MU91-3001	7
MU91-4001	7
MU91-5001	7
MU92-2001	7
MU92-3001	7
MU92-4001	7
MU92-5001	7
MU93-2001	7
MU93-3001	7
MU93-4001	7
MU93-5001	7
NAA101	14
NAA103	14
NAA105	14
NAA107	14
NAA131	9
NAA131M	9
NAA131S	9
NAA133	9
NAA133M	9
NAA133S	9
NAA141	11
NAA141S	11
NAA143	11
NAA143S	11
NAA145	11
NAA147	11
NAA161	13
NAA163	13
NAA241	12
NAA243	12
NAA245	12
NAA247	12
NAA261	13
NAA263	13

INDEX

PART NUMBER	PAGE
NAG101P	14
NAG103P	14
NAG105P	14
NAG107P	14
NAG131MP	9
NAG131P	9
NAG133MP	9
NAG133P	9
NAG141P	11
NAG141SP	11
NAG143P	11
NAG143SP	11
NAG145P	11
NAG147P	11
NAG161P	13
NAG163P	13
NAG241P	12
NAG243P	12
NAG245P	12
NAG247P	12
NAG261P	13
NAG263P	13
NAR101	14
NAR103	14
NAR105	14
NAR107	14
NAR131	9
NAR131ME	9
NAR131S	9
NAR131SP	9
NAR133	9
NAR133ME	9
NAR133S	9
NAR133SP	9
NAR141	11
NAR141S	11
NAR143	11

PART NUMBER	PAGE
NAR143S	11
NAR145	11
NAR147	11
NAR161	13
NAR163	13
NAR241	12
NAR243	12
NAR245	12
NAR247	12
NAR261	13
NAR263	13
NARG105	15
NARG107	15
NARG141	15
NARG143	15
NARG161	15
NARG163	15
NKA101	14
NKA103	14
NKA105	14
NKA107	14
NKA131	9
NKA131M	9
NKA131S	9
NKA133	9
NKA133M	9
NKA133S	9
NKA141	11
NKA141S	11
NKA143	11
NKA143S	11
NKA145	11
NKA147	11
NKA161	13
NKA163	13
NKA241	12
NKA243	12

PART NUMBER	PAGE
NKA245	12
NKA247	12
NKA261	13
NKA263	13
NKG101P	14
NKG103P	14
NKG105P	14
NKG107P	14
NKG131MP	9
NKG131P	9
NKG131SP	9
NKG133MP	9
NKG133P	9
NKG133SP	9
NKG141P	11
NKG141SP	11
NKG143P	11
NKG143SP	11
NKG145P	11
NKG147P	11
NKG161P	13
NKG163P	13
NKG241P	12
NKG243P	12
NKG245P	12
NKG247P	12
NKG261P	13
NKG263P	13
NKR101	14
NKR103	14
NKR105	14
NKR107	14
NKR131	9
NKR131ME	9
NKR131S	9
NKR133	9
NKR133ME	9

INDEX

PART NUMBER	PAGE
NKR133S	9
NKR141	11
NKR141S	11
NKR143	11
NKR143S	11
NKR145	11
NKR147	11
NKR161	13
NKR163	13
NKR241	12
NKR243	12
NKR245	12
NKR247	12
NKR261	13
NKR263	13
NKRG141	15
NKRG143	15
NKRG161	15
NKRG163	15
NSA101	14
NSA103	14
NSA141	10
NSA143	10
NSA145	10
NSA147	10
NSA161	13
NSA163	13
NSG101P	14
NSG103P	14
NSG141P	10
NSG143P	10
NSG145P	10
NSG147P	10
NSG161P	13
NSG163P	13
NSR101	14
NSR103	14

PART NUMBER	PAGE
NSR141	10
NSR143	10
NSR145	10
NSR147	10
NSR161	13
NSR163	13