

VI TELEFILTER

Filter specification

TFS 360K

1/5

Measurement condition

Ambient temperature:	22	°C
Input power level:	0	dBm
Terminating impedance: *		
Input:	118 Ω -10.1 pF	
Output:	150 Ω - 9.9 pF	

Characteristics

Remark:

The reference level for the relative attenuation a_{rel} of the TFS 360K is the minimum of the pass band attenuation a_{min} . The minimum of the pass band attenuation a_{min} is defined as the insertion loss a_e . The centre frequency f_c is the arithmetic mean value of the upper and lower frequencies at the 1 dB filter attenuation level relative to the insertion loss a_e . The nominal frequency f_N is fixed at 360 MHz without any tolerance. The given values for both the relative attenuation a_{rel} and the group delay ripple have to be achieved at the frequencies given below even if the centre frequency f_c is shifted due to the temperature coefficient of frequency TC_f in the operating temperature range and due to a production tolerance for the centre frequency f_c .

D a t a		typ. value		tolerance / limit		
Insertion loss (reference level)	a_e	6.5	dB	max.	10,0	dB
Nominal frequency	f_N				360	MHz
Pass band	PB	36,7	dB	f_N	± 15	MHz
Amplitude ripple	p-p	0,3	dB	max.	1	dB
Amplitude ripple **	p-p	0,3	dB			
Relative attenuation	a_{rel}					
$f_N - 15$ MHz ... $f_N + 15$ MHz		0,3	dB	max.	1	dB
$f_N - 100$ MHz ... $f_N - 75$ MHz		55	dB	min.	40	dB
$f_N - 75$ MHz ... $f_N - 35$ MHz		34	dB	min.	25	dB
$f_N + 35$ MHz ... $f_N + 75$ MHz		35	dB	min.	25	dB
$f_N + 75$ MHz ... $f_N + 100$ MHz		50	dB	min.	40	dB
Group delay ripple in PB	p-p	14	ns	max.	50	ns
Group delay variation **	p-p	2	ns	max.	30	ns
VSWR **		1,5		min.	2	
Input power level ***				max.	20	dBm
Operating temperature range	OTR				-40 °C ... + 85 °C	
Storage temperature range					-45 °C ... + 85 °C	
Temperature coefficient of frequency	TC_f *****	-90	ppm/K		-	

*) The terminating impedances depend on parasitics and q-values of matching elements and the board used, and are to be understood as reference values only. Should there be additional questions do not hesitate to ask for an application note or contact our design team.

**) Applies over any 10MHz in PB

***) This power level is allowed for short term operation (10% of life time) only, the max. input power for continuous operation is 10 dBm.

****) $\Delta f_c(\text{Hz}) = TC_f(\text{ppm/K}) \times (T - T_0) \times f_{r0} (\text{MHz})$.

Generated:

Checked / Approved:

Tele Filter GmbH
Potsdamer Straße 18
D 14 513 TELTOW / Germany
Tel: (+49) 3328 4784-0 / Fax: (+49) 3328 4784-30
E-Mail: tft@telefilter.com

VI TELEFILTER reserves the right to make changes to the product(s) and/or information contained herein without notice. No liability is assumed as a result of their use or application. No rights under any patent accompany the sale of any such product(s) or information.

Filter characteristic

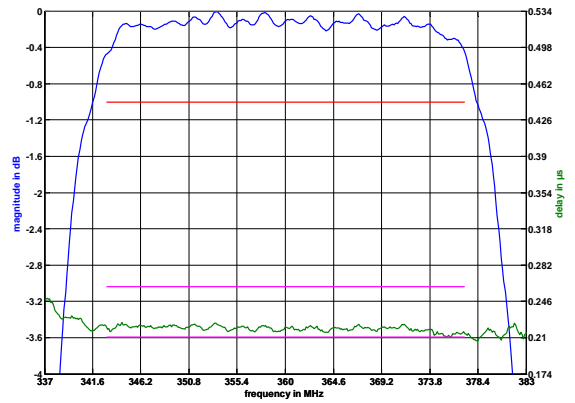
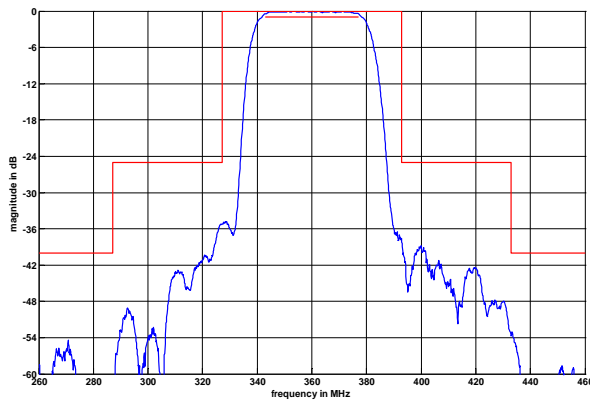

Construction and pin connection

(All dimensions in mm)

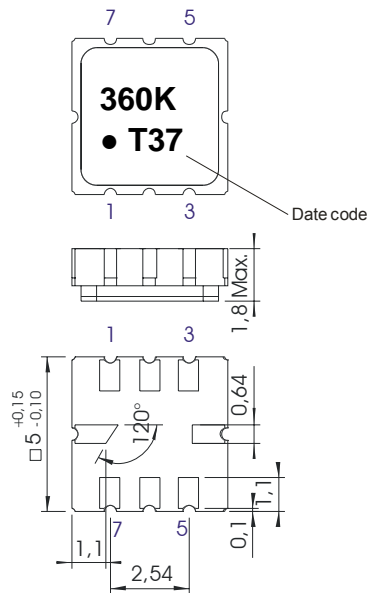

- 1 Input
- 2 Input RF Return
- 3 Ground
- 4 Ground
- 5 Output
- 6 Output RF Return
- 7 Ground
- 8 Ground

Date code: Year + week
 T 2005
 U 2006
 V 2007
 ...

50 Ohm Test circuit

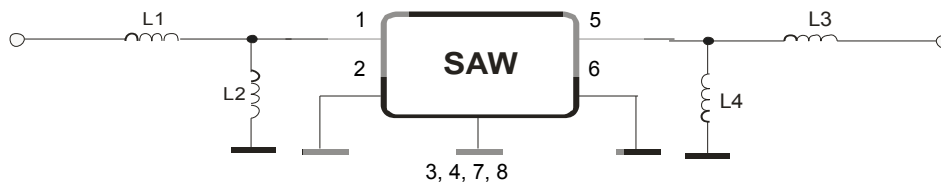

Tele Filter GmbH
 Potsdamer Straße 18
 D 14 513 TELTOW / Germany
 Tel: (+49) 3328 4784-0 / Fax: (+49) 3328 4784-30
 E-Mail: tft@telefilter.com

VI TELEFILTER reserves the right to make changes to the product(s) and/or information contained herein without notice. No liability is assumed as a result of their use or application. No rights under any patent accompany the sale of any such product(s) or information.

Stability characteristics

After the following tests the filter shall meet the whole specification:

1. Shock: 500g, 18 ms, half sine wave, 3 shocks each plane;
DIN IEC 68 T2 - 27
2. Vibration: 10 Hz to 500 Hz, 0,35 mm or 5 g respectively, 1 octave per min, 10 cycles per plan, 3 plans;
DIN IEC 68 T2 - 6
3. Change of temperature: -55 °C to 125°C / 30 min. each / 10 cycles
DIN IEC 68 part 2 – 14 Test N
4. Resistance to solder heat (reflow): reflow possible: twice max.;
for temperature conditions refer to the attached "Air reflow temperature conditions" on page 4;

Packing

Tape & Reel: IEC 286 – 3, with exception of value for N and minimum bending radius;
tape type II, embossed carrier tape with top cover tape on the upper side;

max. pieces of filters peer reel:	3000
reel of empty components at start:	min. 300 mm
reel of empty components at start including leader:	min. 500 mm
trailer:	min. 300 mm

Tape (all dimensions in mm)

- W : 12,00 ± 0,3
- Po : 4,00 ± 0,1
- Do : 1,50 +0,1/-0
- E : 1,75 ± 0,1
- F : 5,50 ± 0,05
- G(min) : 0,75
- P2 : 2,00 ± 0,05
- P1 : 8,00 ± 0,1
- D1(min) : 1,50
- Ao : 5,30 ± 0,1
- Bo : 5,30 ± 0,1
- Ct : 9,5 ± 0,1

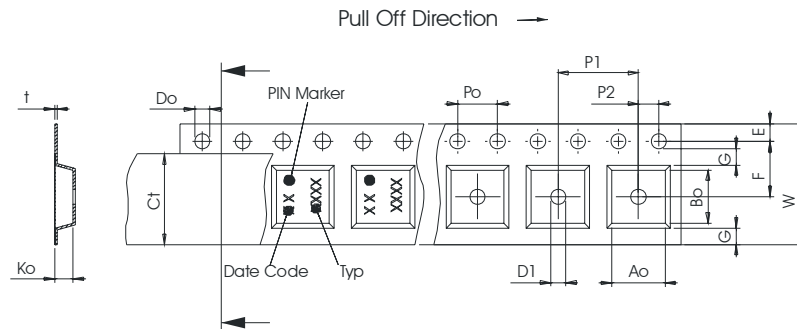

Reel (all dimensions in mm)

- A : 330
- W1 : 12,4 +2/-0
- W2(max) : 18,4
- N(min) : 50
- C : 13,0 +0,5/-0,2

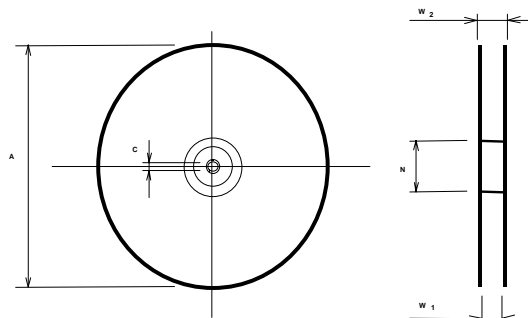

The minimum bending radius is 45 mm.

Tele Filter GmbH
Potsdamer Straße 18
D 14 513 TELTOW / Germany
Tel: (+49) 3328 4784-0 / Fax: (+49) 3328 4784-30
E-Mail: tft@telefilter.com

VI TELEFILTER reserves the right to make changes to the product(s) and/or information contained herein without notice. No liability is assumed as a result of their use or application. No rights under any patent accompany the sale of any such product(s) or information.

Air reflow temperature conditions

Conditions	Exposure
Average ramp-up rate (30°C to 217°C)	less than 3°C/second
> 100°C	between 300 and 600 seconds
> 150°C	between 240 and 500 seconds
> 217°C	between 30 and 150 seconds
Peak temperature	max. 260°C
Time within 5°C of actual peak temperature	between 10 and 30 seconds
Cool-down rate (Peak to 50°C)	less than 6°C/second
Time from 30°C to Peak temperature	no greater than 300 seconds

Chip-mount air reflow profile

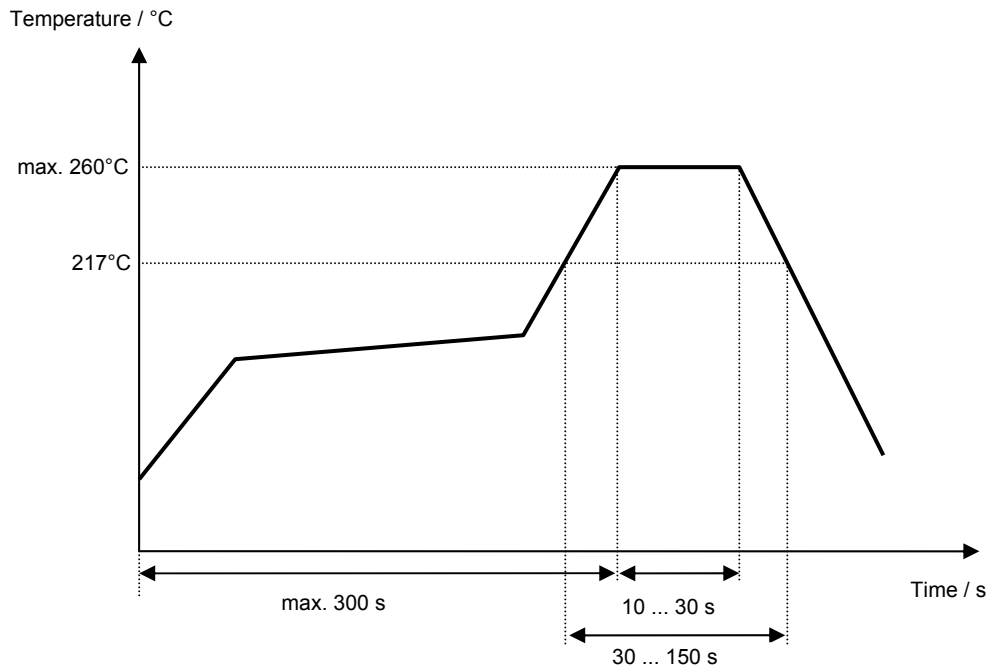

Tele Filter GmbH
 Potsdamer Straße 18
 D 14 513 TELTOW / Germany
 Tel: (+49) 3328 4784-0 / Fax: (+49) 3328 4784-30
 E-Mail: tft@telefilter.com

VI TELEFILTER reserves the right to make changes to the product(s) and/or information contained herein without notice. No liability is assumed as a result of their use or application. No rights under any patent accompany the sale of any such product(s) or information.

VI TELEFILTER**Filter specification****TFS 360K****5/5****History**

Version	Reason of Changes	Name	Date
1.0	- generated specification according to customer requirement	Chilla	02.02.2005
1.1	- changed insertion loss - changed max. amplitude ripple over any 10MHz to typical value	Chilla	13.05.2005
1.1	- created filter specification - added terminating impedance - added typical values - added filter characteristic - changed date code	Chilla	05.09.2005

Tele Filter GmbH
Potsdamer Straße 18
D 14 513 TELTOW / Germany
Tel: (+49) 3328 4784-0 / Fax: (+49) 3328 4784-30
E-Mail: tft@telefilter.com

VI TELEFILTER reserves the right to make changes to the product(s) and/or information contained herein without notice. No liability is assumed as a result of their use or application. No rights under any patent accompany the sale of any such product(s) or information.