

Oval Green LED Lamp (5 mm)

OVLHGKD8

- High luminous intensity
- Defined spatial radiation
- Multiple viewing angles
- UV-resistant epoxy
- Precision optical performance

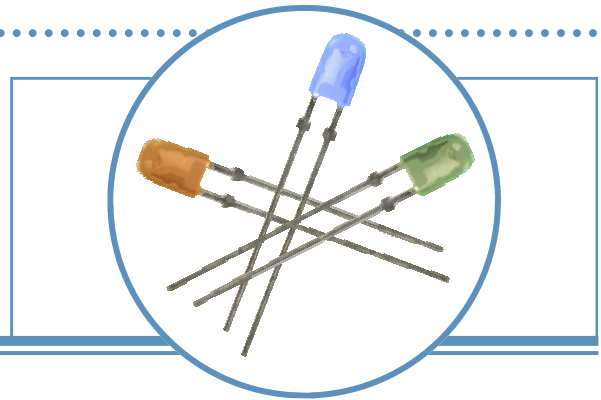

The **OVLHGKD8** is designed for superior performance in outdoor environments. Its radiation pattern matches red (OVLHRKD8), blue (OVLHBKD8), and orange (OVLHQKD8) devices in identical packages to create LED pixels for full-color video screens.

Applications

- Variable message signs
- Indoor/outdoor advertising signage
- Traffic and highway signs
- Full-color video signs

Part Number	Material	Emitted Color	Intensity Typ. mcd	Lens Color
OVLHGKD8	InGaN	Green	1100	Green Diffused

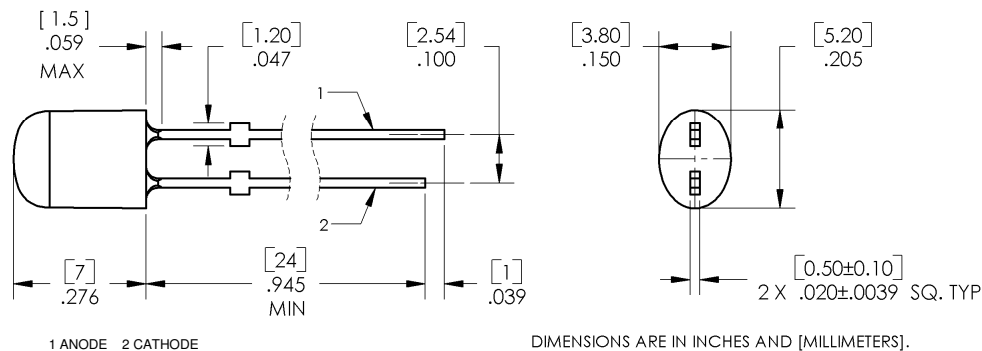

DO NOT LOOK DIRECTLY AT LED WITH UNSHIELDED EYES OR DAMAGE TO RETINA MAY OCCUR.

OPTEK reserves the right to make changes at any time in order to improve design and to supply the best product possible.

Oval Green LED Lamp (5 mm)

OVLHGKD8



Absolute Maximum Ratings

$T_A = 25^\circ\text{C}$ unless otherwise noted

Storage Temperature Range	-40 ~ +100° C
Operating Temperature Range	-40 ~ +95° C
Reverse Voltage	5 V
Continuous Forward Current	25 mA
Peak Forward Current (10% Duty Cycle, 1KHz)	100 mA
Power Dissipation	105 mW
Lead Soldering Temperature (3mm from the base of the epoxy bulb) ¹	260° C

Note:

- Solder time less than 3 seconds at temperature extreme.

Electrical Characteristics

$T_A = 25^\circ\text{C}$ unless otherwise noted

SYMBOL	PARAMETER	MIN	TYP	MAX	UNITS	CONDITIONS
I_V	Luminous Intensity	770	1100	----	mcd	$I_F = 20\text{ mA}$
V_F	Forward Voltage	----	3.6	4.2	V	$I_F = 20\text{ mA}$
I_R	Reverse Current	----	----	100	μA	$V_R = 5\text{ V}$
λ_D	Dominant Wavelength	520	525	535	nm	$I_F = 20\text{ mA}$
$2\Theta_{1/2H-H}$	50% Power Angle	----	110	----	deg	$I_F = 20\text{ mA}$
$2\Theta_{1/2V-V}$		----	50	----	deg	$I_F = 20\text{ mA}$

Standard Bins ($I_F = 20\text{mA}$)

Lamps are sorted to luminous intensity (I_V) and dominant wavelength (λ_D) bins shown. Orders for OVLHGKD8 may be filled with any or all bins contained as below.

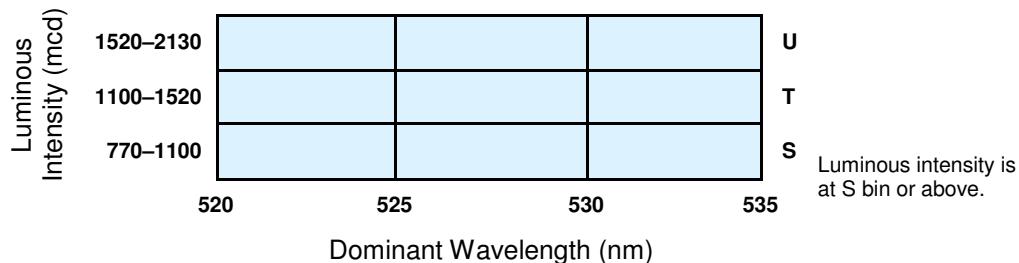

Important Notes:

- All ranks will be included per delivery, rank ratio will be based on the chip distribution.
- To designate luminous intensity ranks, please contact OPTEK.
- Pb content <1000 PPM.

OPTEK reserves the right to make changes at any time in order to improve design and to supply the best product possible.

Typical Electro-Optical Characteristics Curves

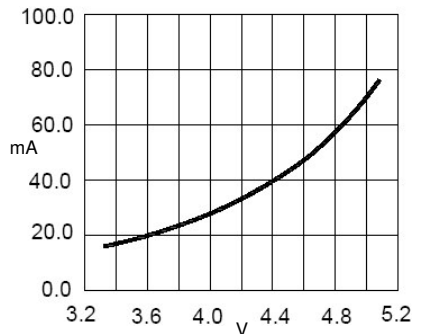

Forward Current vs Forward Voltage

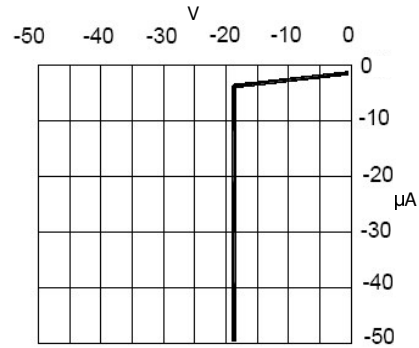

Reverse Current vs Reverse Voltage

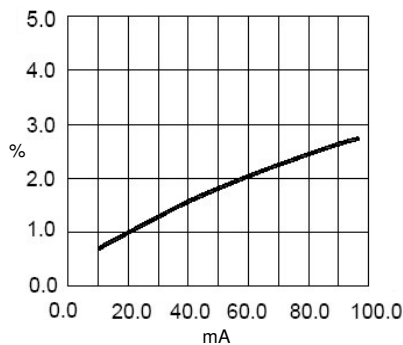

Relative Luminous Intensity vs Forward Current

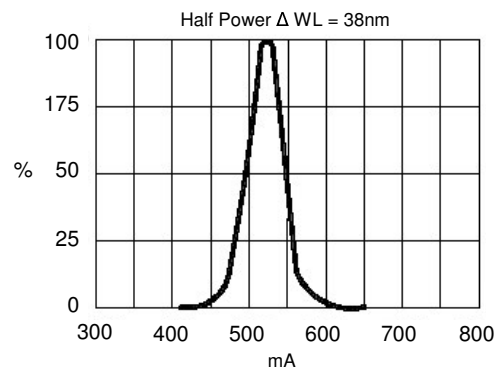

Relative Luminous Intensity vs Wavelength

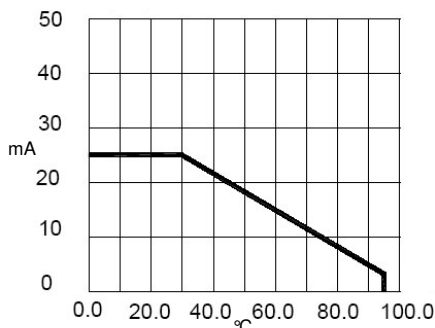

Maximum Forward DC Current vs Ambient Temperature

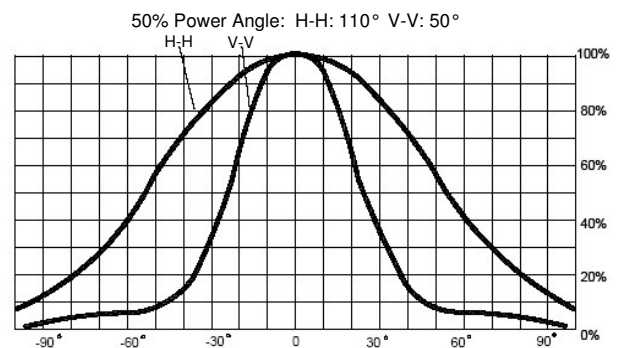

Far Field Pattern

OPTEK reserves the right to make changes at any time in order to improve design and to supply the best product possible.