

Single-chip Type with Built-in FET Switching Regulator Series

# Simple Step-down Switching Regulators with Built-in Power MOSFET

**BD9873CP-V5, BD9874CP-V5**

No.09027EAT39

## ● Description

The BD9873,74CP-V5 single-channel step-down switching regulator incorporates a Pch MOSFET capable, as well as circuitry that eliminates the need for external compensation – only a diode, coil, and ceramic capacitor are required – reducing board size significantly.

## ● Features

- 1) Maximum switching current : 1.5A, 3.0A
- 2) Built-in Pch FET ensures high efficiency
- 3) Output voltage adjustable via external resistors
- 4) High switching frequency : 110kHz (fixed)
- 5) Soft start time : 4ms (fixed)
- 6) Over current and thermal shutdown protection circuits built in
- 7) ON/OFF control via STBY pin

## ● Applications

TVs, printers, DVD players, projectors, gaming devices, PCs, car audio/navigation systems, ETCs, communication equipment, AV products, office equipment, industrial devices, and more.

## ● Absolute Maximum Ratings (Ta=25°C)

Parameter	Symbol	Ratings	Unit
Supply Voltage (VCC-GND)	V <sub>CC</sub>	36	V
STBY-GND	V <sub>STBY</sub>	36	V
OUT-GND	V <sub>OUT</sub>	36	V
INV-GND	V <sub>INV</sub>	5	V
Maximum Switching Current	I <sub>out</sub>	1.5(*1) BD9873	A
Power Dissipation		3.0(*1) BD9874	A
Operating Temperature	P <sub>d</sub>	2000(*2)	mW
Storage Temperature	T <sub>opr</sub>	-40~+85	°C
Supply Voltage (VCC-GND)	T <sub>stg</sub>	-55~+150	°C

(\*1) Do not exceed P<sub>d</sub>, ASO.

(\*2) Derated at 16mW/°C over Ta=25°C

● Operating Conditions ( $T_a = -40 \sim +85^\circ\text{C}$ )

Parameter	Symbol	Limit			Unit	Conditions
		MIN	TYP	MAX		
Input Voltage	VCC	8.0	-	35.0	V	
Output Voltage	Vo	1.0	-	$0.8 \times (V_{CC} - I_o \times R_{on})$	V	

● Electrical Characteristics (Unless otherwise noted,  $T_a = 25^\circ\text{C}$ ,  $V_{CC} = 12\text{V}$ ,  $V_o = 5\text{V}$ ,  $STBY = 3\text{V}$ )

Parameter	Symbol	Limit			Unit	Conditions
		MIN	TYP	MAX		
Output ON Resistance	Ron	-	1.0	1.5	$\Omega$	BD9873
		-	0.5	1.0	$\Omega$	BD9874
Efficiency	$\eta$	80	88	-	%	$I_o = 0.5\text{A}$
Switching Frequency	fosc	99	110	121	kHz	
Load Regulation	$\Delta V_{OLOAD}$	-	5	40	mV	$V_{CC} = 20\text{V}$ , $I_o = 0.5 \sim 1.5\text{A}$ BD9873
		-	5	40	mV	$V_{CC} = 20\text{V}$ , $I_o = 1.0 \sim 3.0\text{A}$ BD9874
Line Regulation	$\Delta V_{OLINE}$	-	5	25	mV	$V_{CC} = 10 \sim 30\text{V}$ , $I_o = 1.0\text{A}$
Over Current Protection Limit	Iocp	1.6	-	-	A	BD9873
		3.2	-	-	A	BD9874
Over Current Protection Limit	VINV	0.985	1.00	1.015	V	
INV Pin Input Current	IINV	-	1	2	$\mu\text{A}$	$V_{INV} = 1.0\text{V}$
STBY Pin Threshold Voltage	ON	VSTBYON	2.0	-	VCC	V
	OFF	VSTBYOFF	-0.3	-	0.3	V
STBY Pin Input Current	Istby	5	15	30	$\mu\text{A}$	STBY=3V
Circuit Current	Icc	-	5	12	mA	INV=2V
Stand-by Current	Ist	-	0	5	$\mu\text{A}$	STBY=0V
Soft Start Time	Tss	-	4	20	ms	STBY=0 $\rightarrow$ 3V

This product is not designed to be resistant to radiation.

●Block Diagram

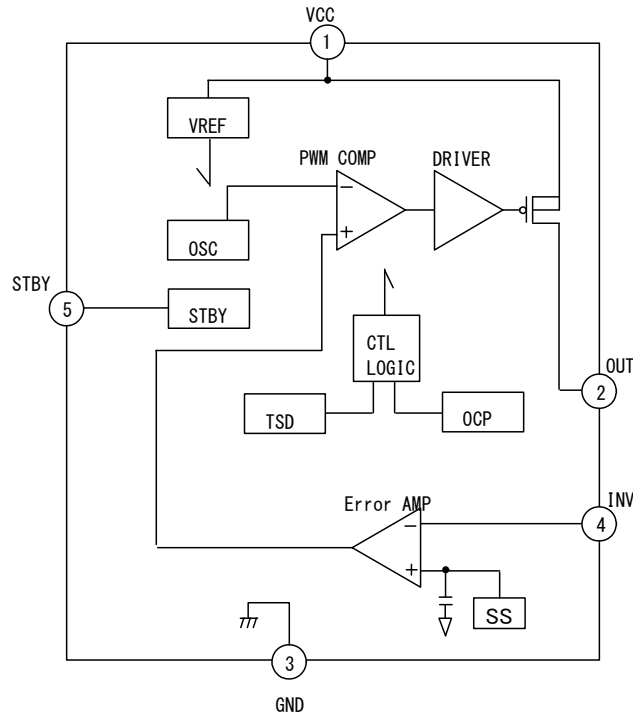
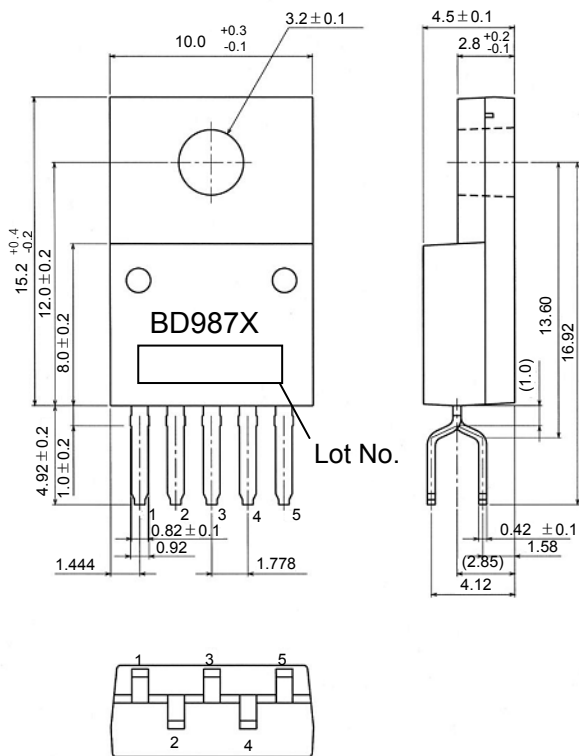

Fig.1

●Package Dimensions



TO220CP-V5 (Unit : mm)

Fig.2

●Pin Description

Pin No.	Pin Name	Function
1	VCC	Input Power Supply Pin
2	OUT	Internal Pch FET Drain Pin
3	GND	Ground
4	INV	Output Voltage Feedback Pin
5	STBY	ON/OFF Control Pin

●Block Function Explanations

- VREF  
Generates the regulated voltage from Vcc input, compensated for temperature.
- OSC  
Generates the triangular wave oscillation frequency (900kHz) using an internal resistors and capacitor. Used for PWM comparator input.
- Error AMP  
This block, via the INV pin, detects the resistor-divided output voltage, compares this with the reference voltage, then amplifies and outputs the difference.
- PWM COMP  
Outputs PWM signals to the Driver block, which converts the error amp output voltage to PWM form.
- DRIVER  
This push-pull FET driver powers the internal Pch MOSFET, which accepts direct PWM input.
- STBY  
Controls ON/OFF operation via the STBY pin. The output is ON when STBY is High.
- Thermal Shutdown (TSD)  
This circuit protects the IC against thermal runaway and damage due to excessive heat. A thermal sensor detects the junction temperature and switches the output OFF once the temperature exceeds a threshold value (175° C). Hysteresis is built in (15° C) in order to prevent malfunctions due to temperature fluctuations.
- Over Current Protection (OCP)  
The OCP circuit detects the voltage difference between Vcc and OUT by measuring the current through the internal Pch MOSFET and switches the output OFF once the voltage reaches the threshold value. The OCP block is a self-recovery type (not latch).
- Soft Start (SS)  
This block conducts soft start operations. When STBY is High and the IC starts up the internal capacitor begins charging. The soft start time is fixed at 5ms.

●Notes for PCB layout

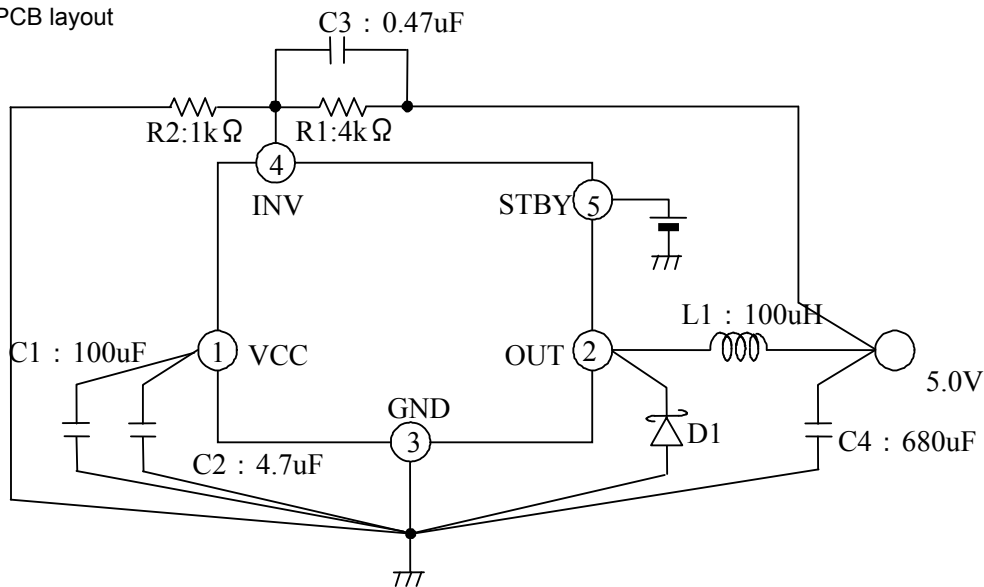

Fig.3

- Place capacitors between Vcc and Ground, and the Schottky diode as close as possible to the IC to reduce noise and maximize efficiency.
- Connect resistors between INV and Ground, and the output capacitor filter at the same Ground potential in order to stabilize the output voltage.

(If the patterning is longer or thin, it's possible to cause ringing or waveform crack.)

●Reference data BD9873CP-V5

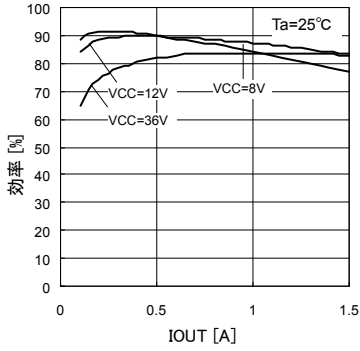

Fig.4 Efficiency-Load Current

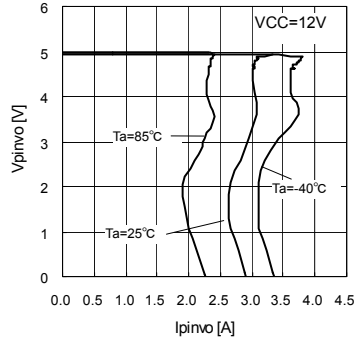

Fig.5 Over Current Protection

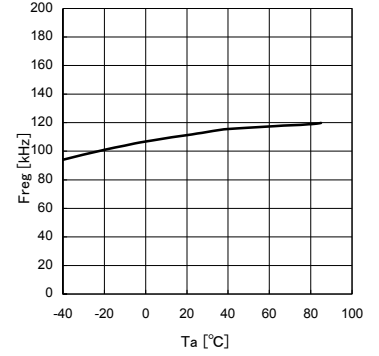

Fig.6 Switching Frequency-Temperature

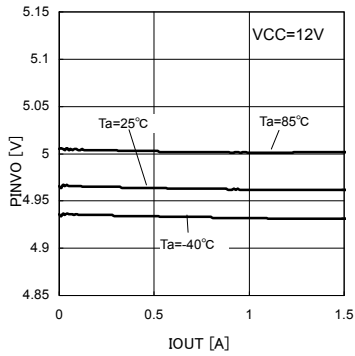

Fig.7 Output voltage- Load Current

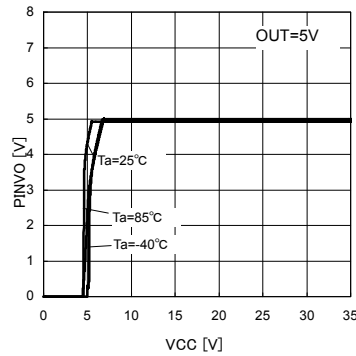

Fig.8 Output voltage-Supply voltage

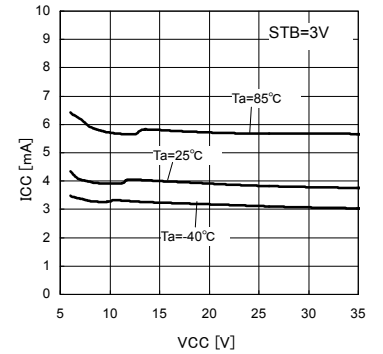

Fig.9 Circuit current-Supply voltage Iout=No Load

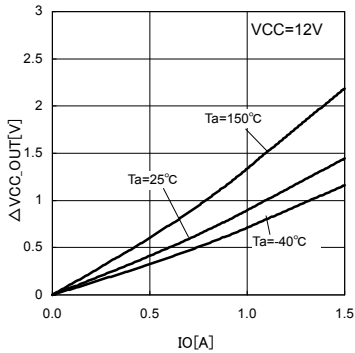

Fig.10 V(VCC-OUT)-Iout

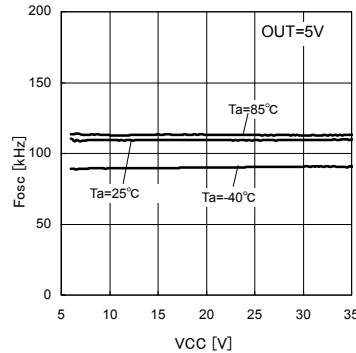

Fig.11 Switching Frequency - Supply

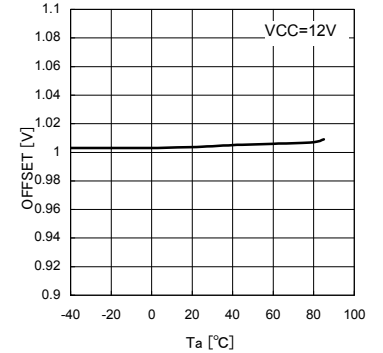

Fig.12 INV Pin Threshold voltage-Temperature

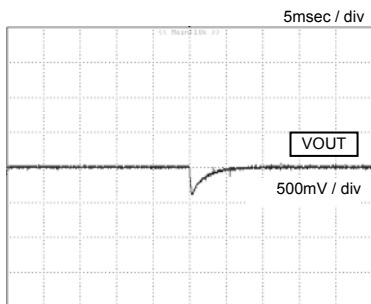

Fig.13 Load Response

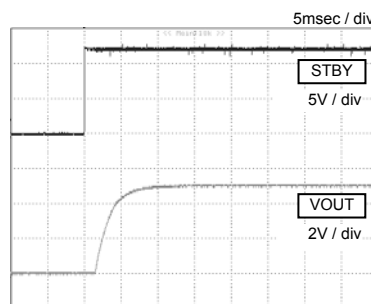

Fig.14 Start-up waveform

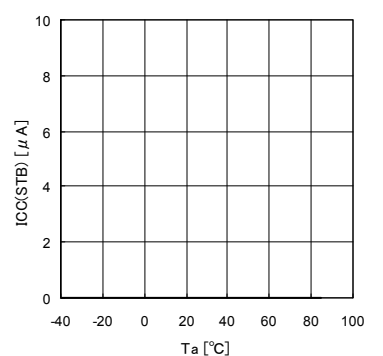

Fig.15 ICC(STB)-Ta

●Reference data BD9874CP-V5

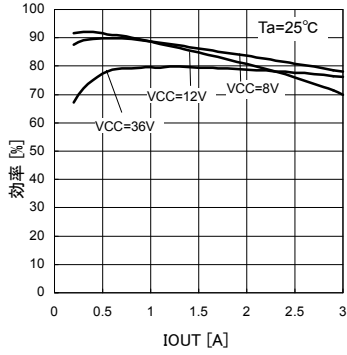

Fig.16 Efficiency - Load Current

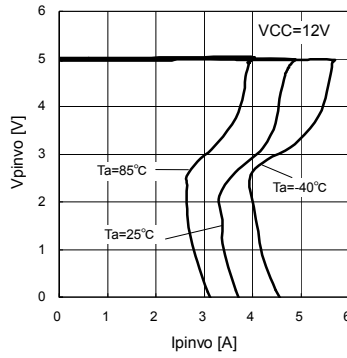

Fig.17 Over Current Protection

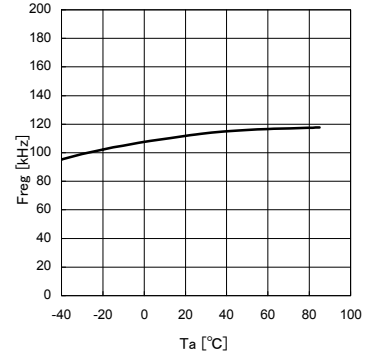

Fig.18 Switching

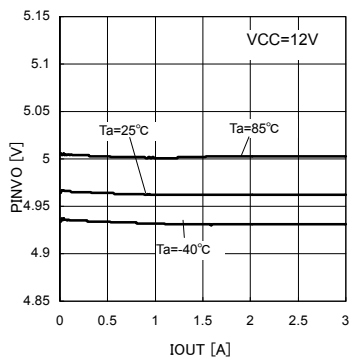

Fig.19 Output voltage - Load Current

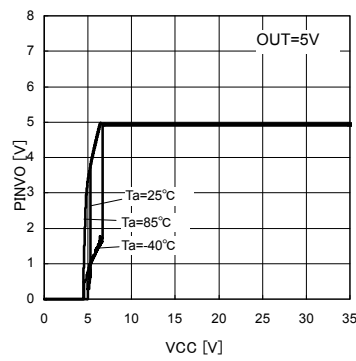

Fig.20 Output voltage-Supply voltage

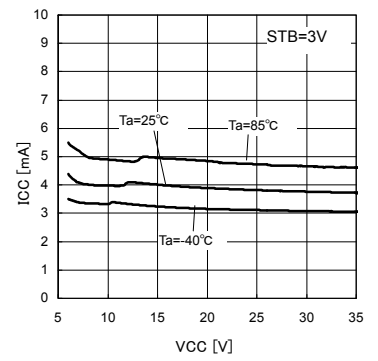

Fig.21 Circuit current-Supply voltage  
Iout= No Load

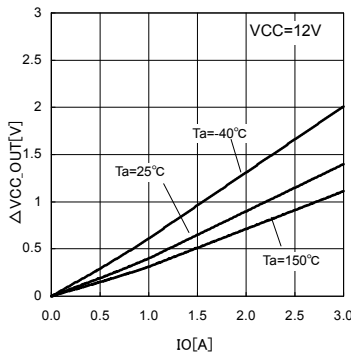

Fig.22 V(VCC-OUT)-Iout

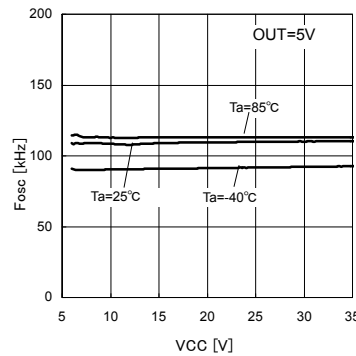

Fig.23 Switching Frequency - Supply voltage

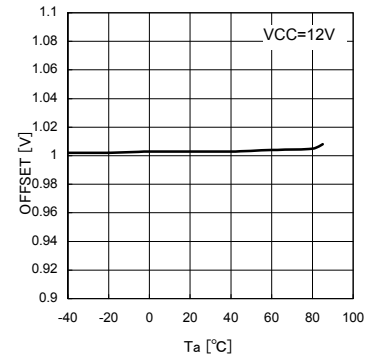

Fig.24 INV Pin Threshold voltage-Temperature

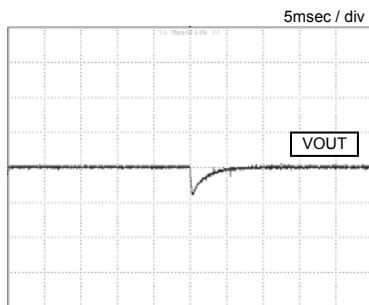

Fig.25 Load Response

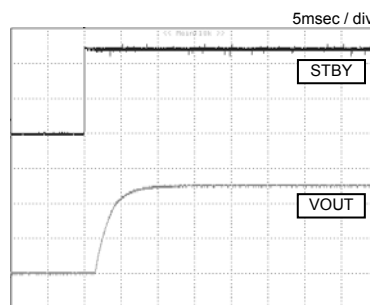

Fig.26 Start-up waveform

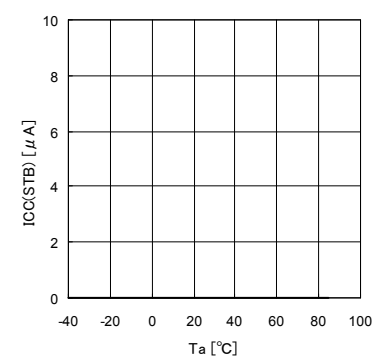

Fig.27 ICC (STB)-Ta

● Application component selection and settings

**Inductor L1**

A large inductor series impedance will result in deterioration of efficiency. OCP operation greater than 1.6A may cause inductor overheating, possibly leading to overload or output short.

Note that the current rating for the coil should be higher than  $I_{OUT}(MAX) + \Delta I_L$ .

$I_{OUT}(MAX)$  : maximum load current

If you flow more than maximum current rating, coil will become overload, and cause magnetic saturation, and those account for efficiency deterioration. Select from enough current rating of coil which doesn't over peak current.

$$\Delta I_L = \frac{(VCC - VOUT)}{L1} \times \frac{VOUT}{VCC} \times \frac{1}{fosc}$$

L1 : inductor value, VCC : maximum input voltage, VOUT : output voltage,  $\Delta I_L$  : coil ripple current value, fosc : oscillation frequency

**Schottky Diode D1**

Select a Schottky diode having an inter-terminal capacity as small as possible (reverse recovery time as short as possible) and a forward voltage  $V_f$  as low as possible. (Noise can be reduced and efficiency improved by reduction of switching noise and switching loss, as well as reduction of voltage drop loss of forward voltage.)

Diode should be selected on the basis of maximum current rating in forward direction, voltage rating in reverse direction, and power dissipation of diode.

- The maximum current rating is higher than the combined maximum load current and coil ripple current ( $\Delta I_L$ ).
- The reverse voltage rating is higher than the  $V_{IN}$  value.
- Power dissipation for the selected diode must be within the rated level.

The power dissipation of the diode is expressed by the following formula:

$$P_{di} = I_{OUT}(MAX) \times V_f \times (1 - VOUT/VCC)$$

$I_{OUT}(MAX)$ : maximum load current,  $V_f$ : forward voltage, VOUT: output voltage, VCC: input voltage

**Output Capacitor C4**

A suitable output capacitor should satisfy the following formula for ESR:

$$ESR \leq \Delta V_L / \Delta I_L$$

$\Delta V_L$  : permissible ripple voltage,  $\Delta I_L$  : coil ripple current

Another factor that must be considered is the permissible ripple current. Select a capacitor with sufficient margin, governed by the following formula:

$$I_{RMS} = \Delta I_L / 2\sqrt{3}$$

$I_{RMS}$ : effective value of ripple current to the output capacitor,  $\Delta I_L$  : coil ripple current

The output capacitor is one of the important parts for system stability, and when some capacitor is selected, expected characteristics cannot be provided, depending on ambient temperature, output voltage setting condition, etc.

Fully confirm ESR, temperature characteristics, DC, and bias characteristics before evaluation.

**Input Capacitor C1,C2**

The input capacitor is the source of current flow to the coil via the built-in Pch FET when the FET is ON. When selecting the input capacitor sufficient margin must be provided to accommodate capacitor voltage and permissible ripple current. The expression below defines the effective value of the ripple current to the input capacitor. It should be used in determining the suitability of the capacitor in providing sufficient margin for the permissible ripple current.

$$I_{RMS} = I_{OUT} \times \sqrt{(1 - VOUT / VCC) \times VOUT / VCC}$$

$I_{RMS}$  : effective value of the ripple current to the input capacitor

$I_{OUT}$  : output load current, VOUT: output voltage, VCC: input voltage

**Capacitor C3**

C3 is for compensating the stability of application frequency characteristics.

When C3 is not available, overshoot or undershoot is possible in starting or in rapid change of load.

Be sure to insert 0.47  $\mu$ F.

**Resistor R1,R2**

These resistors determine the output voltage:

$$V_{OUT} = 1.0V \times (1 + R1/R2)$$

Select resistors less than 10k $\Omega$ .

## BD9873CP-V5

## &lt;Recommended Components (Example)&gt;

Inductor	L1=100 $\mu$ H : RCR1616 (SUMIDA)
Schottky Diode	D1=RB050LA-40 (ROHM)
Capacitor	C1=100 $\mu$ F : Al electric capacitor
	C2=4.7 $\mu$ F : Laminated ceramic capacitor
	C3=0.47 $\mu$ F : Laminated ceramic capacitor
	C4=680 $\mu$ F : Al electric capacitor

## BD9874CP-V5

## &lt;Recommended Components (Example)&gt;

Inductor	L1=RCR1616 (SUMIDA)
Schottky Diode	D1=RB050LA-40 (ROHM)
Capacitor	C1=100 $\mu$ F : Al electric capacitor
	C2=4.7 $\mu$ F : Laminated ceramic capacitor
	C3=0.47 $\mu$ F : Laminated ceramic capacitor
	C4=680 $\mu$ F : Al electric capacitor



● Power Dissipation

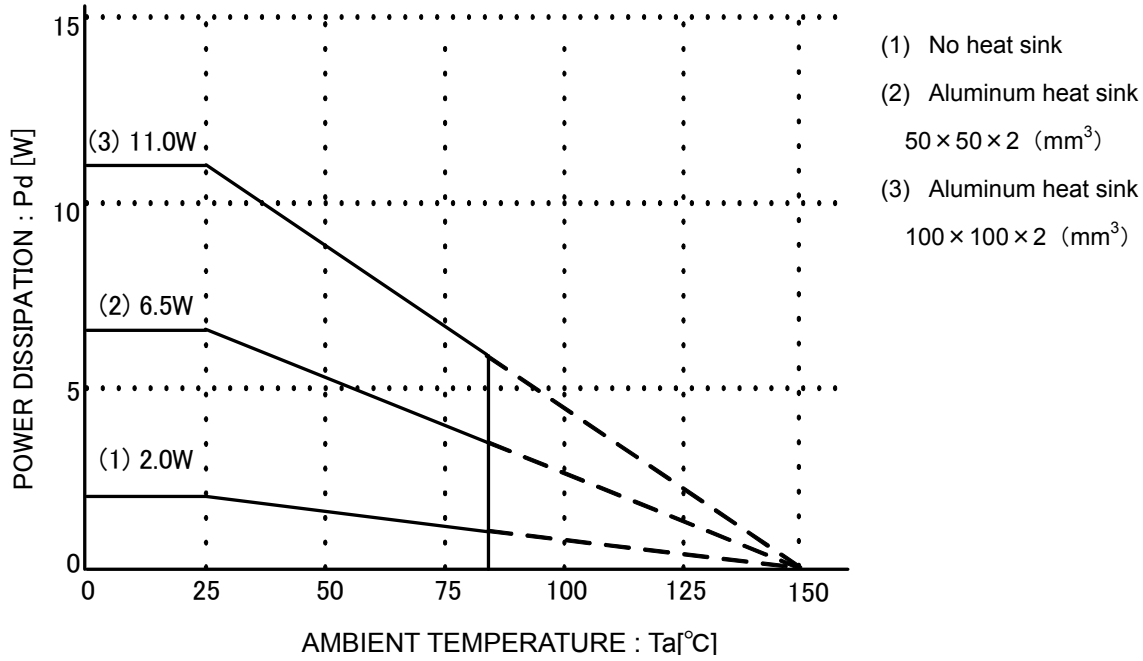

Fig.28

● Tj (tip junction temperature) calculating method

It is impossible to measure the tip junction temperature Tj outside the IC, but it can be calculated by the formula shown below.

Calculation method of tip junction temperature Tj

$$T_j = (W \times \theta_{j-c}) + T_c$$

- W : Power consumed by IC (calculated by the formula below)
- $\theta_{j-c}$  : Thermal resistance from the tip to the back of the package  
12.5 °C/W for TO220 package
- Tc : IC surface temperature (to be measured by thermocouple, etc.)

Calculation method of electric power W consumed by IC

$$W = V_{in} \times I_{in} - V_{OUT} \times I_{OUT} - V_F \times I_{OUT} \times (1 - V_{OUT}/V_{in})$$

- Vin : Input voltage
- Iin : Input current
- VOUT : Output voltage
- IOUT : Load Current
- VF : Forward voltage of Schottky diode

● I/O Equivalent Circuit

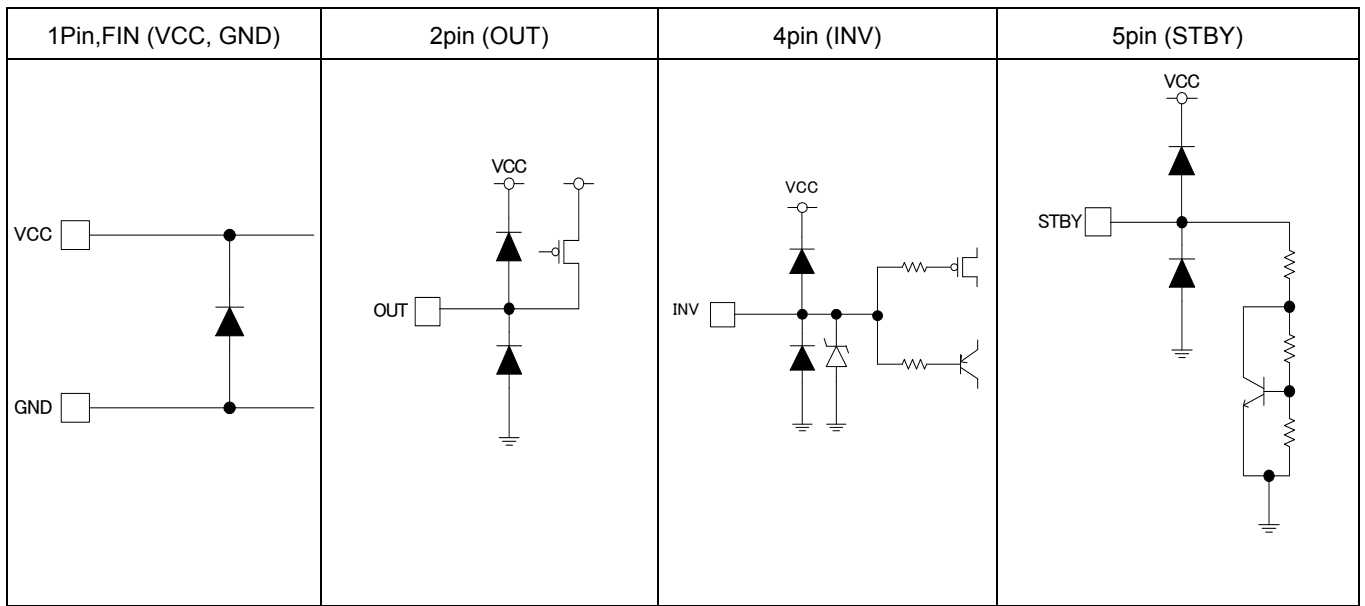

● Operation Notes

1) Absolute maximum ratings

Use of the IC in excess of absolute maximum ratings such as the applied voltage or operating temperature range may result in IC deterioration or damage. Assumptions should not be made regarding the state of the IC (short mode or open mode) when such damage is suffered. A physical safety measure such as a fuse should be implemented when use of the IC in a special mode where the absolute maximum ratings may be exceeded is anticipated.

2) GND potential

Ensure a minimum GND pin potential in all operating conditions. In addition, ensure that no pins other than the GND pin carry a voltage lower than or equal to the GND pin, including during actual transient phenomena.

3) Thermal design

Use a thermal design that allows for a sufficient margin in light of the power dissipation (Pd) in actual operating conditions.

4) Inter-pin shorts and mounting errors

Use caution when orienting and positioning the IC for mounting on printed circuit boards. Improper mounting may result in damage to the IC. Shorts between output pins or between output pins and the power supply and GND pin caused by the presence of a foreign object may result in damage to the IC.

5) Operation in a strong electromagnetic field

Use caution when using the IC in the presence of a strong electromagnetic field as doing so may cause the IC to malfunction.

6) Thermal shutdown circuit (TSD circuit)

This IC incorporates a built-in thermal shutdown circuit (TSD circuit). The TSD circuit is designed only to shut the IC off to prevent runaway thermal operation. Do not continue to use the IC after operating this circuit or use the IC in an environment where the operation of the thermal shutdown circuit is assumed.

7) Testing on application boards

When testing the IC on an application board, connecting a capacitor to a pin with low impedance subjects the IC to stress. Always discharge capacitors after each process or step. Ground the IC during assembly steps as an antistatic measure, and use similar caution when transporting or storing the IC. Always turn the IC's power supply off before connecting it to or removing it from a jig or fixture during the inspection process.

8) Common impedance

Power supply and ground wiring should reflect consideration of the need to lower common impedance and minimize ripple as much as possible (by making wiring as short and thick as possible or rejecting ripple by incorporating inductance and capacitance).

9) Applications with modes that reverse VCC and pin potentials may cause damage to internal IC circuits.

For example, such damage might occur when VCC is shorted with the GND pin while an external capacitor is charged.

It is recommended to insert a diode for preventing back current flow in series with VCC or bypass diodes between VCC and each pin.

10) IC pin input

This monolithic IC contains P+ isolation and PCB layers between adjacent elements in order to keep them isolated.

P/N junctions are formed at the intersection of these P layers with the N layers of other elements to create a variety of parasitic elements. For example, when a resistor and transistor are connected to pins as shown in following chart,

○ the P/N junction functions as a parasitic diode when  $GND > (Pin A)$  for the resistor or  $GND > (Pin B)$  for the transistor (NPN).

○ Similarly, when  $GND > (Pin B)$  for the transistor (NPN), the parasitic diode described above combines with the N layer of other adjacent elements to operate as a parasitic NPN transistor.

The formation of parasitic elements as a result of the relationships of the potentials of different pins is an inevitable result of the IC's architecture. The operation of parasitic elements can cause interference with circuit operation as well as IC malfunction and damage. For these reasons, it is necessary to use caution so that the IC is not used in a way that will trigger the operation of parasitic elements, such as by the application of voltages lower than the GND (PCB) voltage to input and output pins.

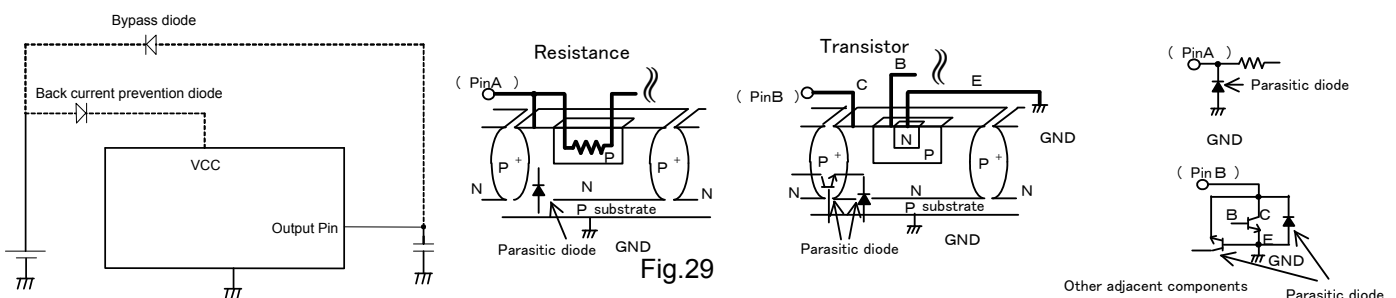

● Part order number

B	D	9	8	7	3	C	P	—	V	5	E	2
Part No.		Type/No.				Package CP-V5 : TO220CP-V5			Packaging and forming specification E2 : Embossed tape and reel			

TO220CP-V5

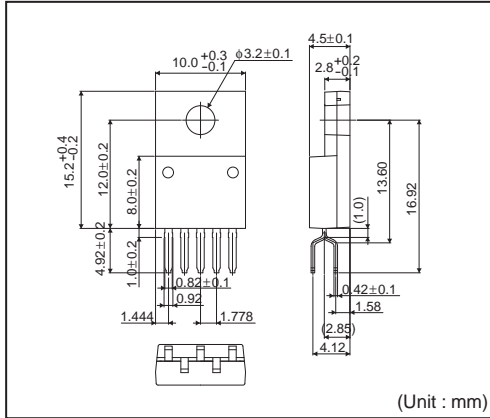

<包装仕様>

包装形態	エンボステーピング
包装数量	500pcs
包装方向	E2 ( リールを左手に持ち、右手でテープを引き出したときに ) 製品の1番ピンが左下にくる方向 )

※ご発注の際は、包装数量の倍数でお願い致します。

## Notes

No copying or reproduction of this document, in part or in whole, is permitted without the consent of ROHM Co.,Ltd.

The content specified herein is subject to change for improvement without notice.

The content specified herein is for the purpose of introducing ROHM's products (hereinafter "Products"). If you wish to use any such Product, please be sure to refer to the specifications, which can be obtained from ROHM upon request.

Examples of application circuits, circuit constants and any other information contained herein illustrate the standard usage and operations of the Products. The peripheral conditions must be taken into account when designing circuits for mass production.

Great care was taken in ensuring the accuracy of the information specified in this document. However, should you incur any damage arising from any inaccuracy or misprint of such information, ROHM shall bear no responsibility for such damage.

The technical information specified herein is intended only to show the typical functions of and examples of application circuits for the Products. ROHM does not grant you, explicitly or implicitly, any license to use or exercise intellectual property or other rights held by ROHM and other parties. ROHM shall bear no responsibility whatsoever for any dispute arising from the use of such technical information.

The Products specified in this document are intended to be used with general-use electronic equipment or devices (such as audio visual equipment, office-automation equipment, communication devices, electronic appliances and amusement devices).

The Products specified in this document are not designed to be radiation tolerant.

While ROHM always makes efforts to enhance the quality and reliability of its Products, a Product may fail or malfunction for a variety of reasons.

Please be sure to implement in your equipment using the Products safety measures to guard against the possibility of physical injury, fire or any other damage caused in the event of the failure of any Product, such as derating, redundancy, fire control and fail-safe designs. ROHM shall bear no responsibility whatsoever for your use of any Product outside of the prescribed scope or not in accordance with the instruction manual.

The Products are not designed or manufactured to be used with any equipment, device or system which requires an extremely high level of reliability the failure or malfunction of which may result in a direct threat to human life or create a risk of human injury (such as a medical instrument, transportation equipment, aerospace machinery, nuclear-reactor controller, fuel-controller or other safety device). ROHM shall bear no responsibility in any way for use of any of the Products for the above special purposes. If a Product is intended to be used for any such special purpose, please contact a ROHM sales representative before purchasing.

If you intend to export or ship overseas any Product or technology specified herein that may be controlled under the Foreign Exchange and the Foreign Trade Law, you will be required to obtain a license or permit under the Law.



Thank you for your accessing to ROHM product informations.  
More detail product informations and catalogs are available, please contact us.

## ROHM Customer Support System

<http://www.rohm.com/contact/>