

## Cool MOS™ Power Transistor

### Feature

- New revolutionary high voltage technology
- Ultra low gate charge
- Periodic avalanche rated
- Extreme dv/dt rated
- Ultra low effective capacitances
- Improved transconductance
- PG-TO-220-3-31: Fully isolated package (2500 VAC; 1 minute)
- Pb-free lead plating; RoHS compliant
- Qualified according to JEDEC<sup>0)</sup> for target applications

|                     |      |          |
|---------------------|------|----------|
| $V_{DS} @ T_{jmax}$ | 560  | V        |
| $R_{DS(on)}$        | 0.95 | $\Omega$ |
| $I_D$               | 4.5  | A        |

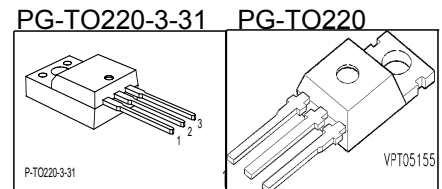

| Type       | Package       | Ordering Code | Marking |
|------------|---------------|---------------|---------|
| SPP04N50C3 | PG-TO220      | Q67040-S4575  | 04N50C3 |
| SPA04N50C3 | PG-TO220-3-31 | SP000216298   | 04N50C3 |

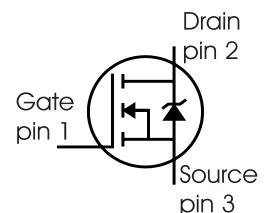

### Maximum Ratings

| Parameter   | Symbol              | Value      |  | Unit             |
|---|---------------------|------------|--|------------------|
|   |                     | SP         | SPA                                    |                  |
| Continuous drain current<br>$T_C = 25\text{ }^\circ\text{C}$<br>$T_C = 100\text{ }^\circ\text{C}$                 | $I_D$               | 4.5<br>2.8 | 4.5 <sup>1)</sup><br>2.8 <sup>1)</sup> | A                |
| Pulsed drain current, $t_p$ limited by $T_{jmax}$   | $I_{D\text{ puls}}$ | 13.5       | 13.5                                   | A                |
| Avalanche energy, single pulse<br>$I_D=3.4\text{A}, V_{DD}=50\text{V}$  | $E_{AS}$            | 130        | 130                                    | mJ               |
| Avalanche energy, repetitive $t_{AR}$ limited by $T_{jmax}$ <sup>2)</sup><br>$I_D=4.5\text{A}, V_{DD}=50\text{V}$ | $E_{AR}$            | 0.4        | 0.4                                    |                  |
| Avalanche current, repetitive $t_{AR}$ limited by $T_{jmax}$  | $I_{AR}$            | 4.5        | 4.5                                    | A                |
| Gate source voltage   | $V_{GS}$            | $\pm 20$   | $\pm 20$                               | V                |
| Gate source voltage AC ( $f > 1\text{Hz}$ )   | $V_{GS}$            | $\pm 30$   | $\pm 30$                               |                  |
| Power dissipation, $T_C = 25\text{ }^\circ\text{C}$   | $P_{tot}$           | 50         | 31                                     | W                |
| Operating and storage temperature   | $T_j, T_{stg}$      | -55...+150 |  | $^\circ\text{C}$ |
| Reverse diode dv/dt <sup>7)</sup>   | dv/dt               | 15         |  | V/ns             |

**Maximum Ratings**

| Parameter   | Symbol  | Value | Unit |
|---|---------|-------|------|
| Drain Source voltage slope<br>$V_{DS} = 400 \text{ V}$ , $I_D = 4.5 \text{ A}$ , $T_j = 125 \text{ }^\circ\text{C}$ | $dv/dt$ | 50    | V/ns |

**Thermal Characteristics**

| Parameter   | Symbol                | Values |      |      | Unit |
|---|-----------------------|--------|------|------|------|
|   |                       | min.   | typ. | max. |      |
| Thermal resistance, junction - case   | $R_{thJC}$            | -      | -    | 2.5  | K/W  |
| Thermal resistance, junction - case, FullPAK  | $R_{thJC \text{ FP}}$ | -      | -    | 4    |      |
| Thermal resistance, junction - ambient, leaded  | $R_{thJA}$            | -      | -    | 62   |      |
| Thermal resistance, junction - ambient, FullPAK   | $R_{thJA \text{ FP}}$ | -      | -    | 80   |      |
| SMD version, device on PCB:<br>@ min. footprint<br>@ 6 cm <sup>2</sup> cooling area <sup>3)</sup> | $R_{thJA}$            | -      | -    | 62   |      |
| Soldering temperature, wavesoldering<br>1.6 mm (0.063 in.) from case for 10s <sup>4)</sup>        | $T_{sold}$            | -      | -    | 260  | °C   |

**Electrical Characteristics, at  $T_j=25^\circ\text{C}$  unless otherwise specified**

| Parameter                                | Symbol        | Conditions   | Values |      |      | Unit          |
|--|---------------|--|--------|------|------|---------------|
|  |               |  | min.   | typ. | max. |               |
| Drain-source breakdown voltage           | $V_{(BR)DSS}$ | $V_{GS}=0\text{V}$ , $I_D=0.25\text{mA}$   | 500    | -    | -    | V             |
| Drain-Source avalanche breakdown voltage | $V_{(BR)DS}$  | $V_{GS}=0\text{V}$ , $I_D=4.5\text{A}$   | -      | 600  | -    |               |
| Gate threshold voltage                   | $V_{GS(th)}$  | $I_D=200\mu\text{A}$ , $V_{GS}=V_{DS}$   | 2.1    | 3    | 3.9  |               |
| Zero gate voltage drain current          | $I_{DSS}$     | $V_{DS}=500\text{V}$ , $V_{GS}=0\text{V}$ ,<br>$T_j=25^\circ\text{C}$<br>$T_j=150^\circ\text{C}$ | -      | 0.1  | 1    | $\mu\text{A}$ |
| Gate-source leakage current              | $I_{GSS}$     | $V_{GS}=20\text{V}$ , $V_{DS}=0\text{V}$   | -      | -    | 100  |               |
| Drain-source on-state resistance         | $R_{DS(on)}$  | $V_{GS}=10\text{V}$ , $I_D=2.8\text{A}$ ,<br>$T_j=25^\circ\text{C}$<br>$T_j=150^\circ\text{C}$   | -      | 0.85 | 0.95 | $\Omega$      |
| Gate input resistance                    | $R_G$         | $f=1\text{MHz}$ , open drain   | -      | 1.4  | -    |               |

**Electrical Characteristics**

| Parameter   | Symbol       | Conditions  | Values |      |      | Unit |
|---|--------------|---|--------|------|------|------|
|   |              |   | min.   | typ. | max. |      |
| Transconductance  | $g_{fs}$     | $V_{DS} \geq 2 \cdot I_D \cdot R_{DS(on)max}$ ,<br>$I_D = 2.8A$ | -      | 4.4  | -    | S    |
| Input capacitance   | $C_{iss}$    | $V_{GS} = 0V$ , $V_{DS} = 25V$ ,                                | -      | 470  | -    | pF   |
| Output capacitance  | $C_{oss}$    | $f = 1MHz$  | -      | 160  | -    |      |
| Reverse transfer capacitance                                  | $C_{rss}$    |   | -      | 15   | -    |      |
| Effective output capacitance, <sup>5)</sup><br>energy related | $C_{o(er)}$  | $V_{GS} = 0V$ ,<br>$V_{DS} = 0V$ to $400V$                      | -      | 27   | -    |      |
| Effective output capacitance, <sup>6)</sup><br>time related   | $C_{o(tr)}$  |   | -      | 44   | -    |      |
| Turn-on delay time  | $t_{d(on)}$  | $V_{DD} = 350V$ , $V_{GS} = 0/10V$ ,                            | -      | 10   | -    | ns   |
| Rise time   | $t_r$        | $I_D = 4.5A$ ,  | -      | 5    | -    |      |
| Turn-off delay time   | $t_{d(off)}$ | $R_G = 18\Omega$  | -      | 70   | -    |      |
| Fall time   | $t_f$        |   | -      | 10   | -    |      |

**Gate Charge Characteristics**

|                       |                 |   |   |     |   |    |
|-----------------------|-----------------|---|---|-----|---|----|
| Gate to source charge | $Q_{gs}$        | $V_{DD} = 400V$ , $I_D = 4.5A$                            | - | 2.2 | - | nC |
| Gate to drain charge  | $Q_{gd}$        |   | - | 10  | - |    |
| Gate charge total     | $Q_g$           | $V_{DD} = 400V$ , $I_D = 4.5A$ ,<br>$V_{GS} = 0$ to $10V$ | - | 22  | - |    |
| Gate plateau voltage  | $V_{(plateau)}$ | $V_{DD} = 400V$ , $I_D = 4.5A$                            | - | 5   | - | V  |

<sup>0</sup>J-STD20 and JESD22

<sup>1</sup>Limited only by maximum temperature

<sup>2</sup>Repetitive avalanche causes additional power losses that can be calculated as  $P_{AV} = E_{AR} \cdot f$ .

<sup>3</sup>Device on 40mm\*40mm\*1.5mm epoxy PCB FR4 with 6cm<sup>2</sup> (one layer, 70 μm thick) copper area for drain connection. PCB is vertical without blown air.

<sup>4</sup>Soldering temperature for TO-263: 220°C, reflow

<sup>5</sup> $C_{o(er)}$  is a fixed capacitance that gives the same stored energy as  $C_{oss}$  while  $V_{DS}$  is rising from 0 to 80%  $V_{DSS}$ .

<sup>6</sup> $C_{o(tr)}$  is a fixed capacitance that gives the same charging time as  $C_{oss}$  while  $V_{DS}$  is rising from 0 to 80%  $V_{DSS}$ .

<sup>7</sup> $I_{SD} \leq I_D$ ,  $di/dt \leq 400A/us$ ,  $V_{DClink} = 400V$ ,  $V_{peak} < V_{BR, DSS}$ ,  $T_j < T_{j,max}$ .

Identical low-side and high-side switch.

**Electrical Characteristics**

| Parameter                                     | Symbol       | Conditions                        | Values |      |      | Unit                   |
|---|--------------|-----------------------------------|--------|------|------|------------------------|
|   |              |                                   | min.   | typ. | max. |                        |
| Inverse diode continuous forward current      | $I_S$        | $T_C=25^\circ\text{C}$            | -      | -    | 4.5  | A                      |
| Inverse diode direct current, pulsed          | $I_{SM}$     |                                   | -      | -    | 13.5 |                        |
| Inverse diode forward voltage                 | $V_{SD}$     | $V_{GS}=0\text{V}, I_F=I_S$       | -      | 1    | 1.2  | V                      |
| Reverse recovery time                         | $t_{rr}$     | $V_R=400\text{V}, I_F=I_S,$       | -      | 280  | -    | ns                     |
| Reverse recovery charge                       | $Q_{rr}$     | $di_F/dt=100\text{A}/\mu\text{s}$ | -      | 2.3  | -    | $\mu\text{C}$          |
| Peak reverse recovery current                 | $I_{rrm}$    |                                   | -      | 16   | -    | A                      |
| Peak rate of fall of reverse recovery current | $di_{rr}/dt$ | $T_j=25^\circ\text{C}$            | -      | 860  | -    | $\text{A}/\mu\text{s}$ |

**Typical Transient Thermal Characteristics**

| Symbol    | Value |       | Unit | Symbol    | Value      |            | Unit |
|-----------|-------|-------|------|-----------|------------|------------|------|
|           | SPP_B | SPA   |      |           | SPP_B      | SPA        |      |
| $R_{th1}$ | 0.039 | 0.039 | K/W  | $C_{th1}$ | 0.00007347 | 0.00007347 | Ws/K |
| $R_{th2}$ | 0.074 | 0.074 |      | $C_{th2}$ | 0.0002831  | 0.0002831  |      |
| $R_{th3}$ | 0.132 | 0.132 |      | $C_{th3}$ | 0.0004062  | 0.0004062  |      |
| $R_{th4}$ | 0.555 | 0.272 |      | $C_{th4}$ | 0.001215   | 0.001215   |      |
| $R_{th5}$ | 0.529 | 0.559 |      | $C_{th5}$ | 0.00276    | 0.005633   |      |
| $R_{th6}$ | 0.169 | 2.523 |      | $C_{th6}$ | 0.029      | 0.412      |      |

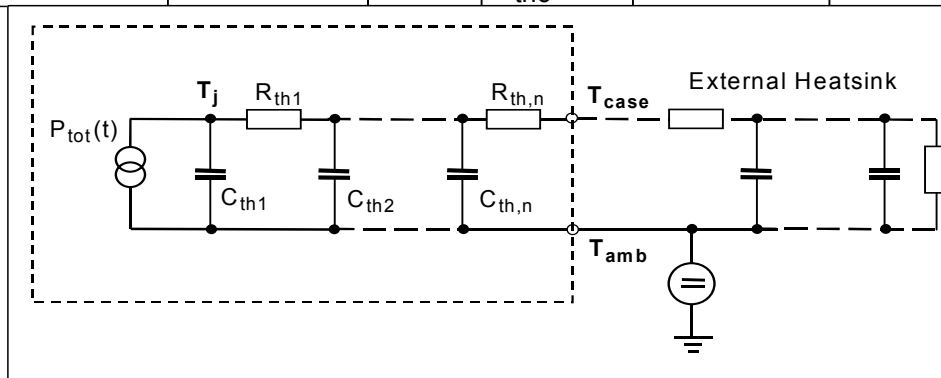

**1 Power dissipation**

$P_{tot} = f(T_C)$

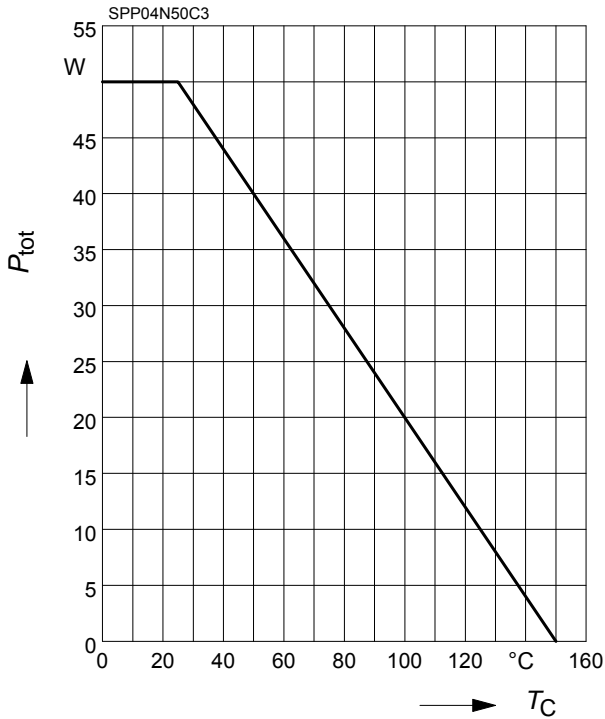

**2 Power dissipation FullPAK**

$P_{tot} = f(T_C)$

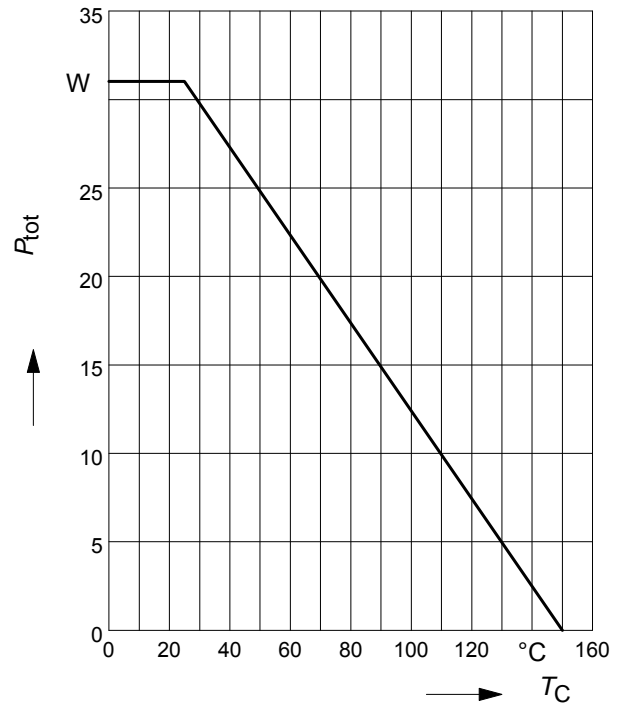

**3 Safe operating area**

$I_D = f(V_{DS})$

parameter :  $D = 0$  ,  $T_C = 25^\circ\text{C}$

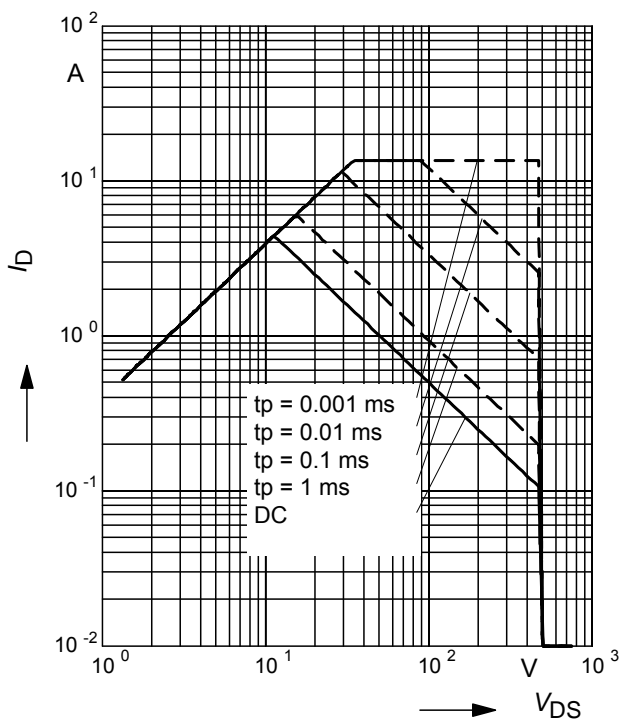

**4 Safe operating area FullPAK**

$I_D = f(V_{DS})$

parameter:  $D = 0$  ,  $T_C = 25^\circ\text{C}$

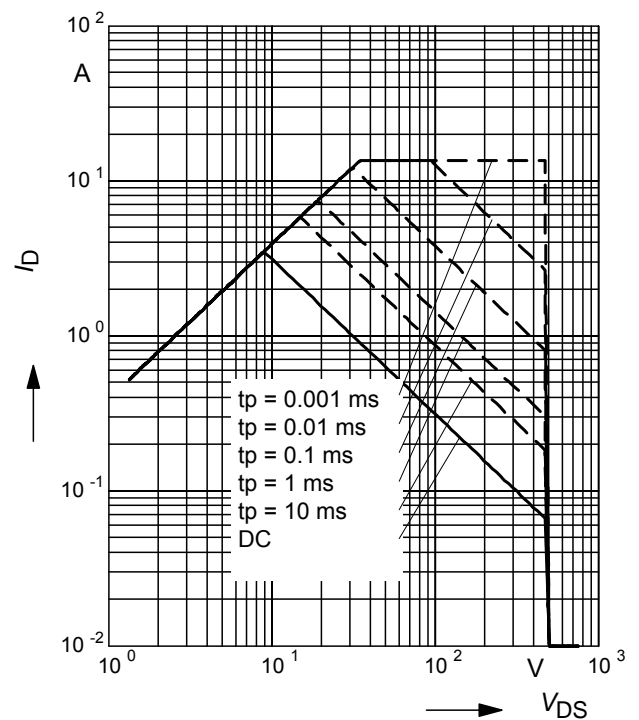

### 5 Transient thermal impedance

$$Z_{thJC} = f(t_p)$$

parameter:  $D = t_p/T$

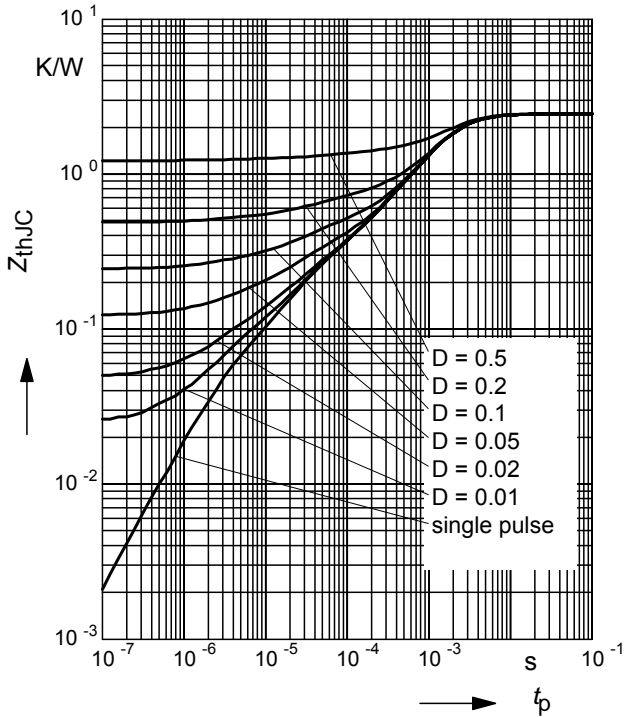

### 6 Transient thermal impedance FullPAK

$$Z_{thJC} = f(t_p)$$

parameter:  $D = t_p/t$

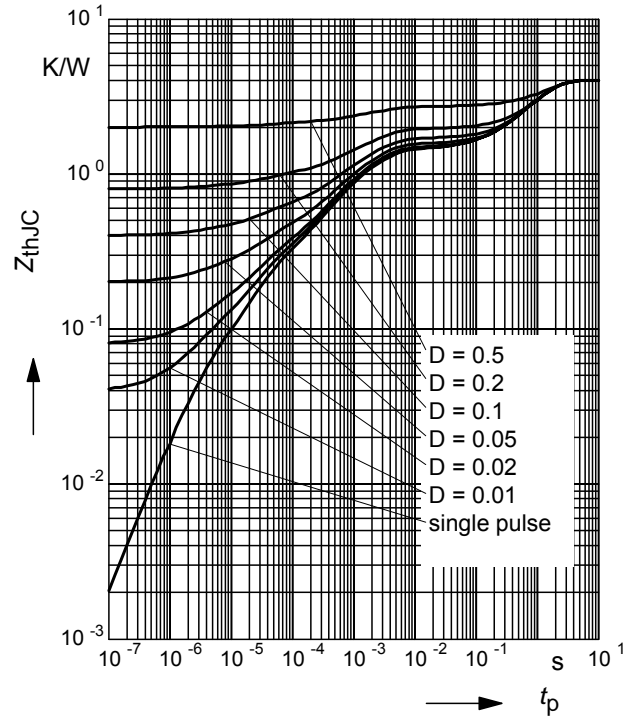

### 7 Typ. output characteristic

$$I_D = f(V_{DS}); T_j = 25^\circ\text{C}$$

parameter:  $t_p = 10 \mu\text{s}, V_{GS}$

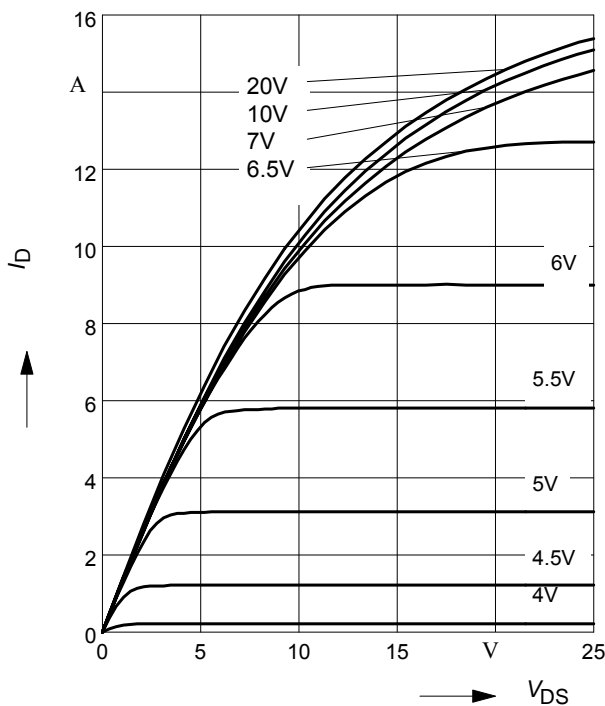

### 8 Typ. output characteristic

$$I_D = f(V_{DS}); T_j = 150^\circ\text{C}$$

parameter:  $t_p = 10 \mu\text{s}, V_{GS}$

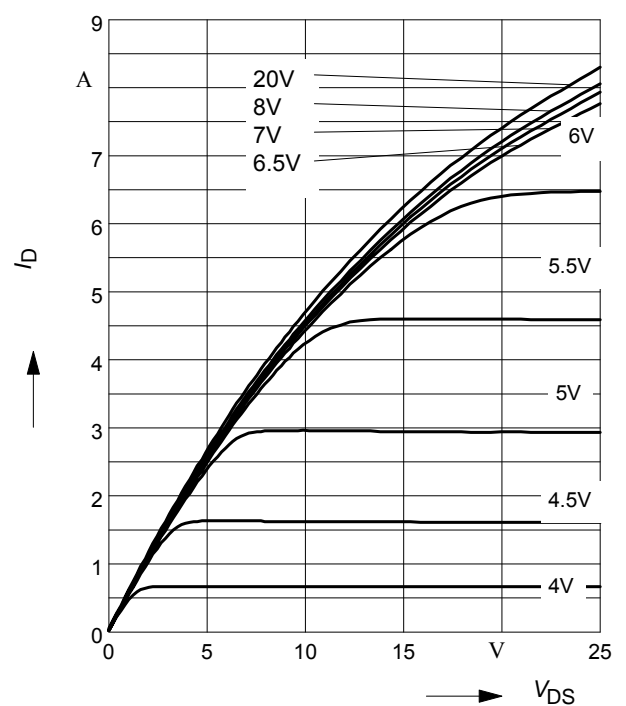

**9 Typ. drain-source on resistance**

$$R_{DS(on)} = f(I_D)$$

parameter:  $T_j = 150^\circ\text{C}$ ,  $V_{GS}$

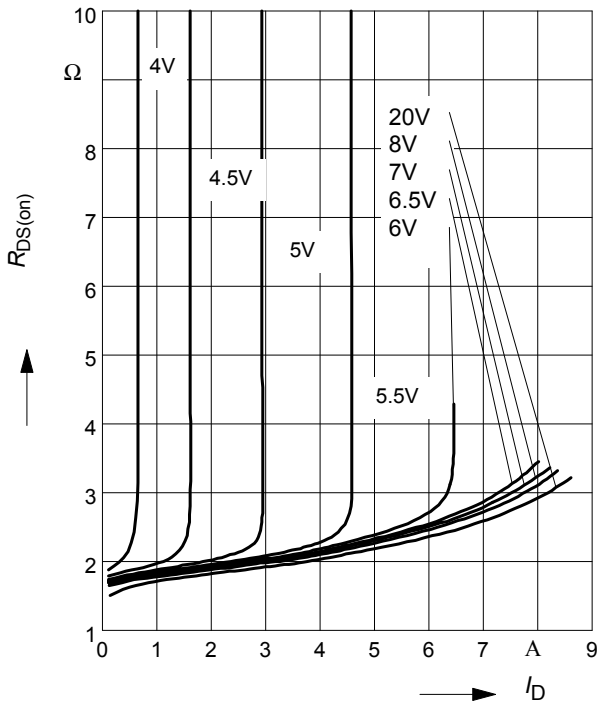

**10 Drain-source on-state resistance**

$$R_{DS(on)} = f(T_j)$$

parameter:  $I_D = 2.8\text{ A}$ ,  $V_{GS} = 10\text{ V}$

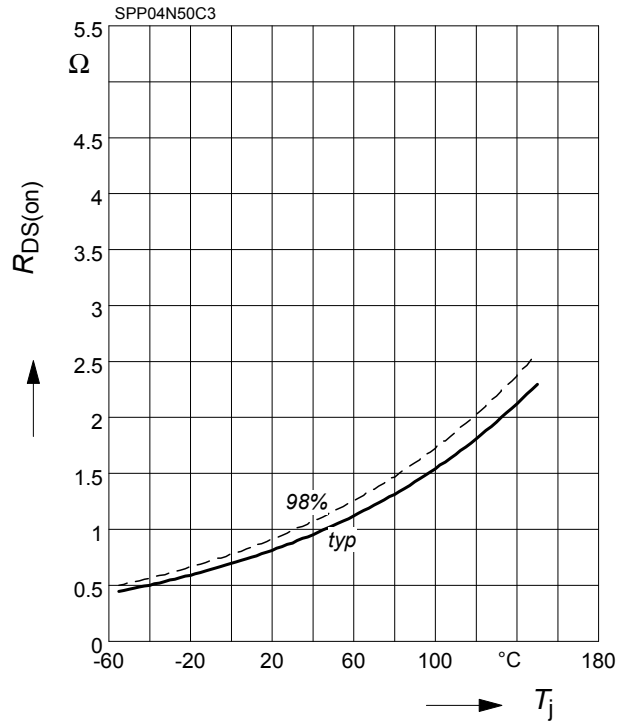

**11 Typ. transfer characteristics**

$$I_D = f(V_{GS}); V_{DS} \geq 2 \times I_D \times R_{DS(on)max}$$

parameter:  $t_p = 10\ \mu\text{s}$

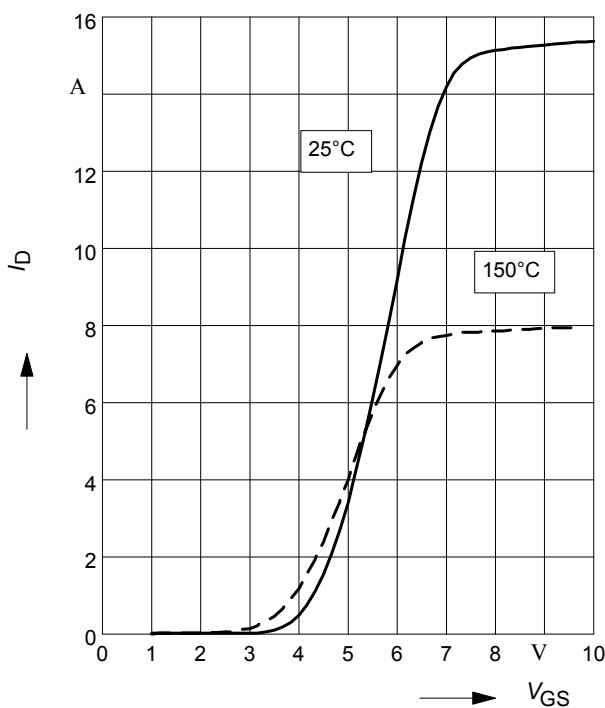

**12 Typ. gate charge**

$$V_{GS} = f(Q_{Gate})$$

parameter:  $I_D = 4.5\text{ A pulsed}$

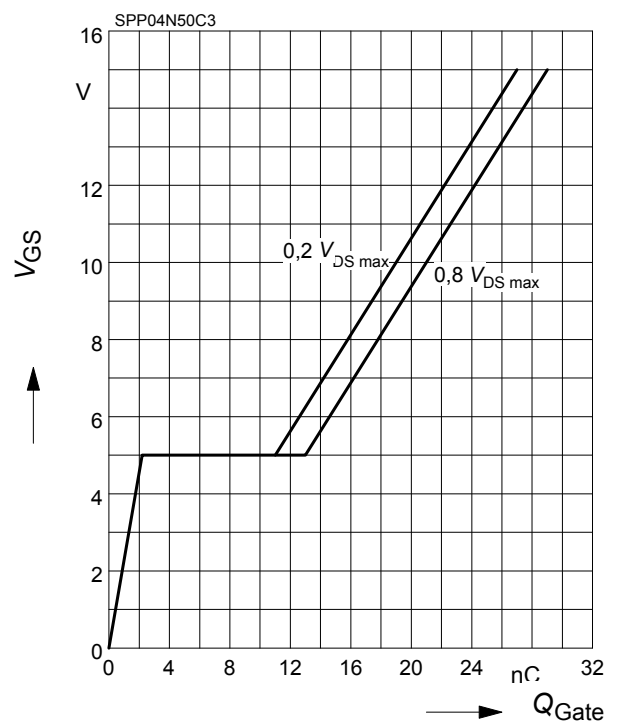

### 13 Forward characteristics of body diode

$$I_F = f(V_{SD})$$

parameter:  $T_j$ ,  $t_p = 10 \mu s$

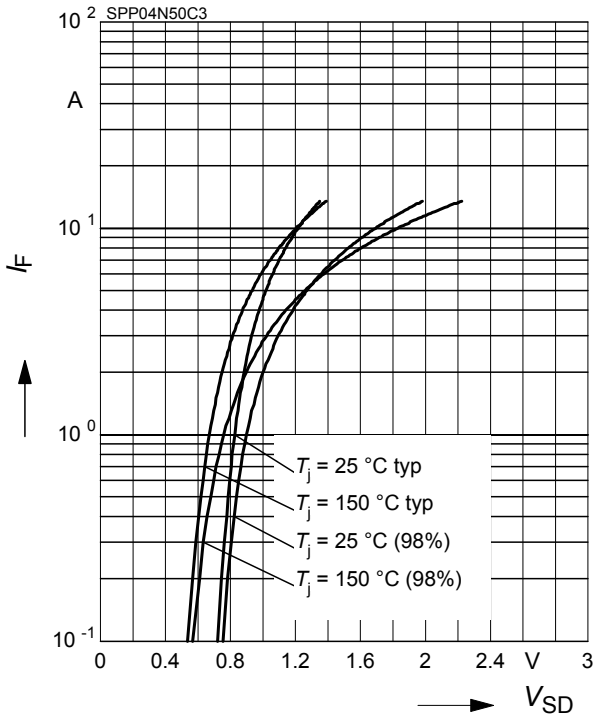

### 14 Avalanche SOA

$$I_{AR} = f(t_{AR})$$

par.:  $T_j \leq 150 \text{ °C}$

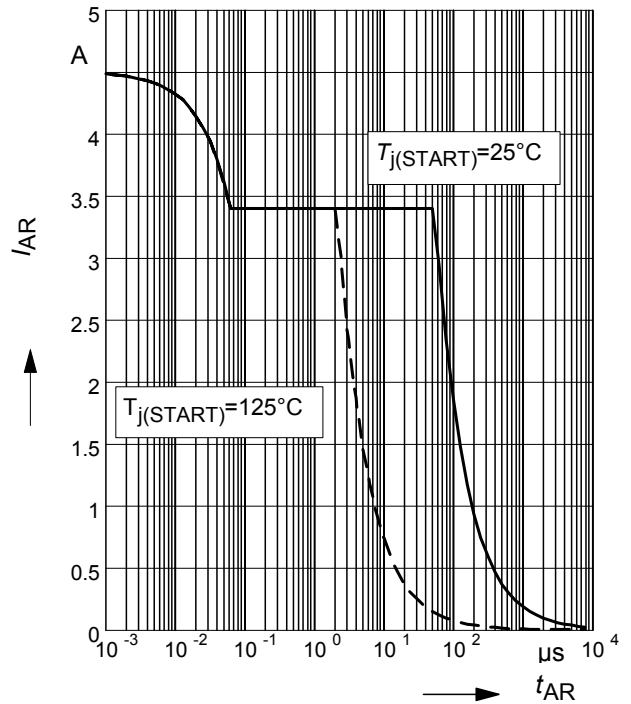

### 15 Avalanche energy

$$E_{AS} = f(T_j)$$

par.:  $I_D = 3.4 \text{ A}$ ,  $V_{DD} = 50 \text{ V}$

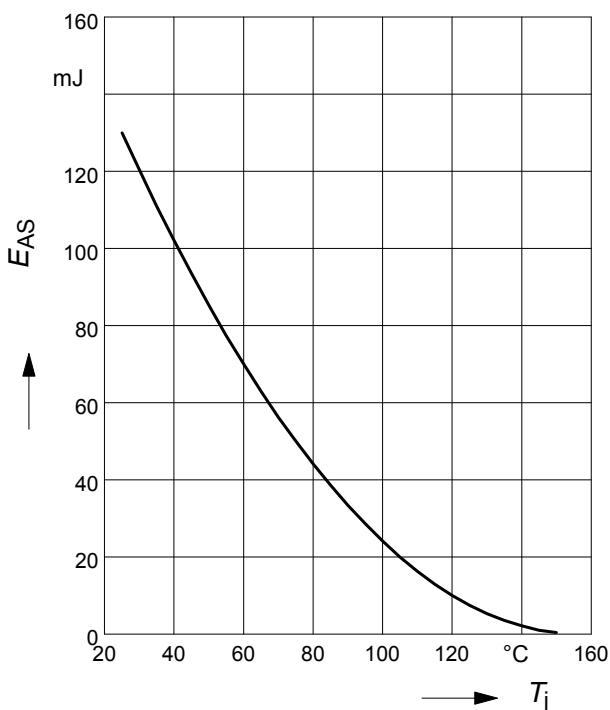

### 16 Drain-source breakdown voltage

$$V_{(BR)DSS} = f(T_j)$$

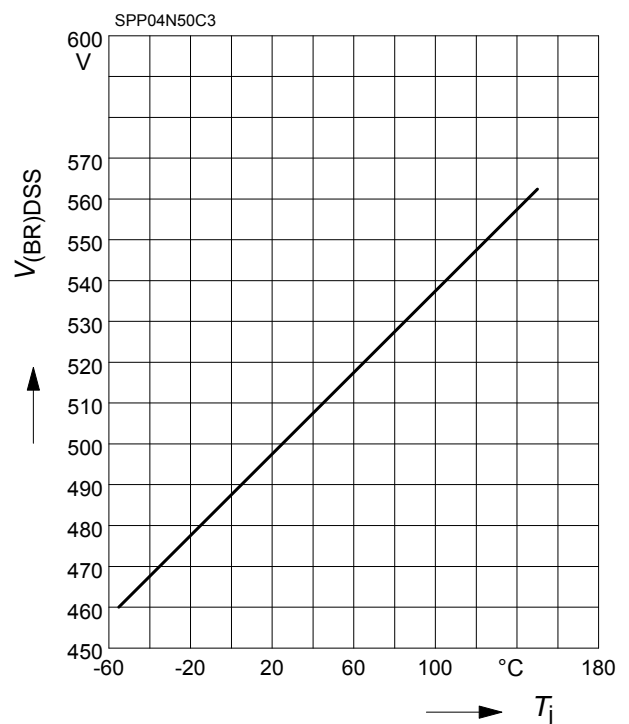



### 17 Avalanche power losses

$$P_{AR} = f(f)$$

parameter:  $E_{AR}=0.4\text{mJ}$

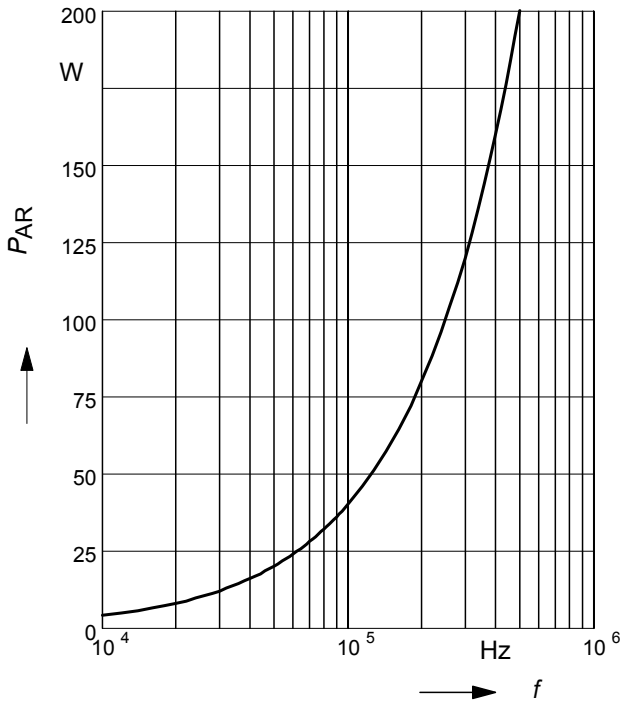

### 18 Typ. capacitances

$$C = f(V_{DS})$$

parameter:  $V_{GS}=0\text{V}$ ,  $f=1\text{ MHz}$

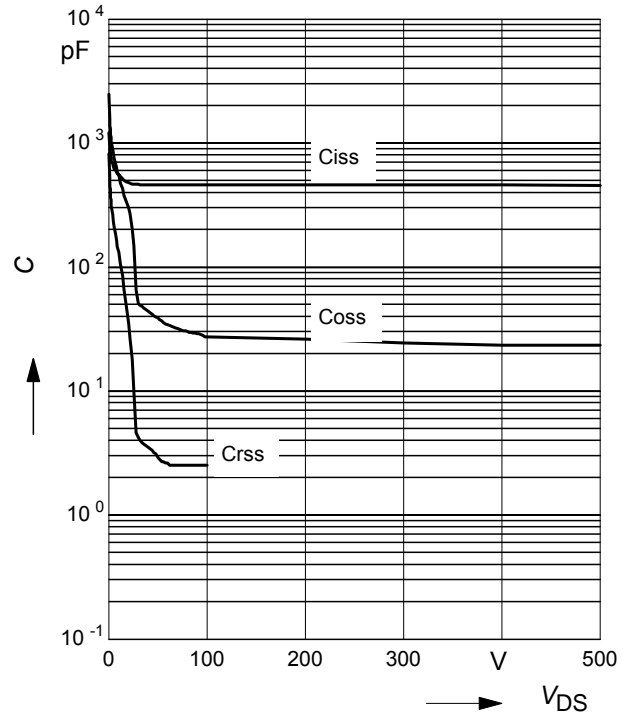

### 19 Typ. $C_{oss}$ stored energy

$$E_{oss} = f(V_{DS})$$

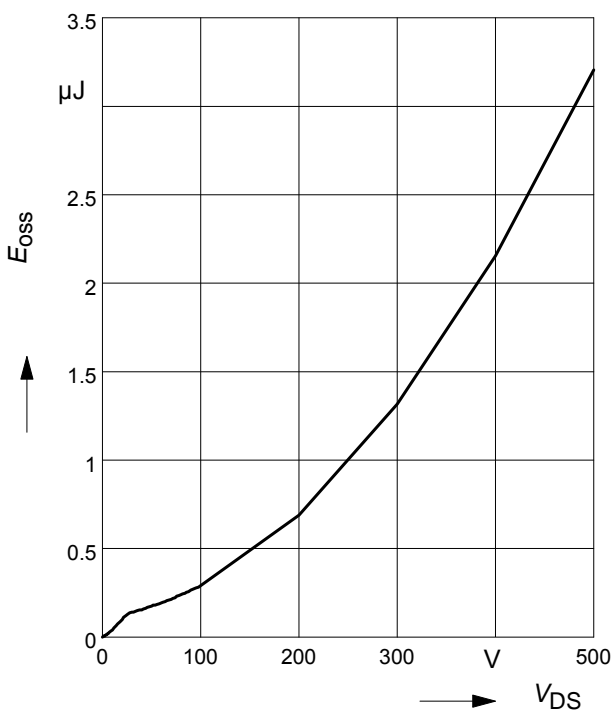

Definition of diodes switching characteristics

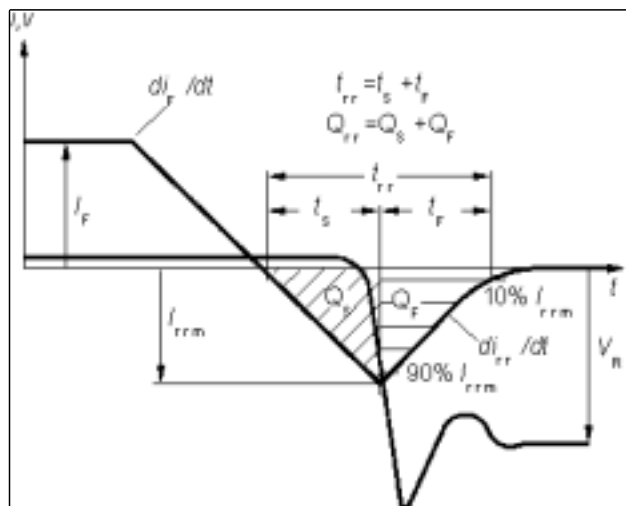

PG-TO220-3-1, PG-TO220-3-21

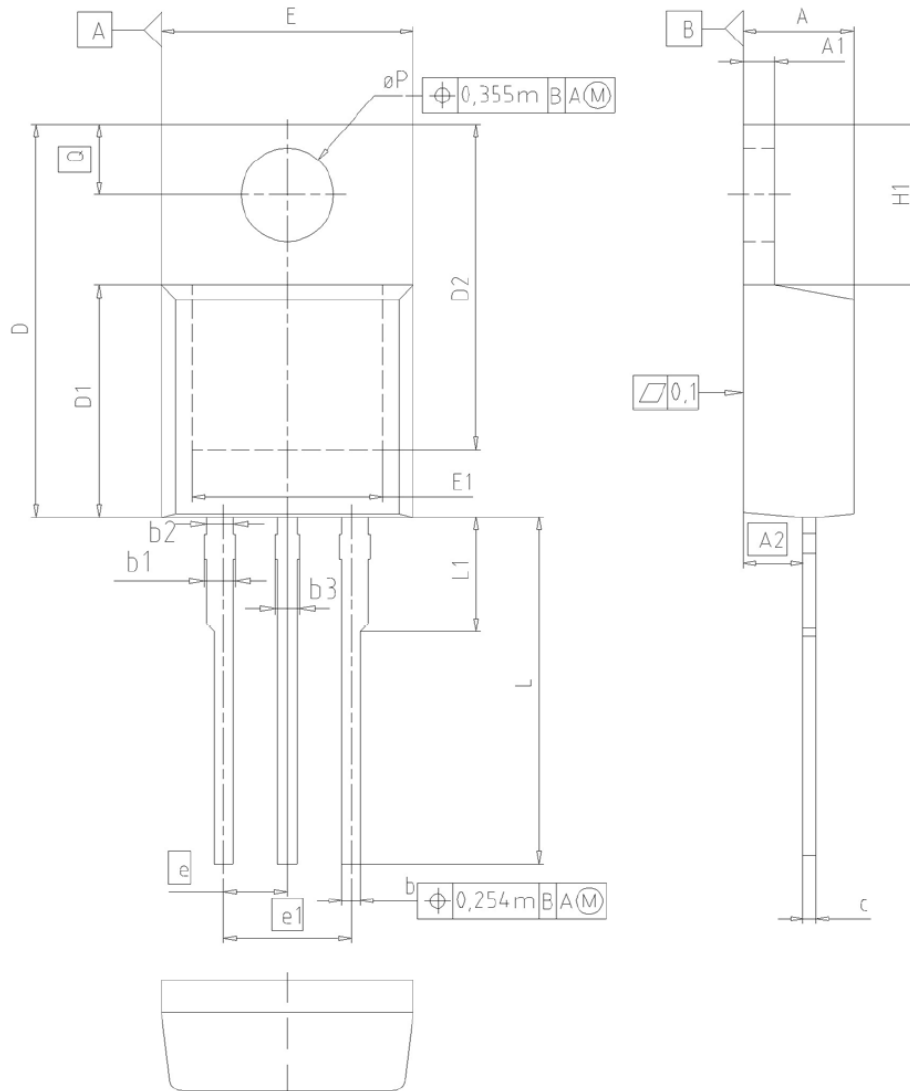

| DIM      | MILLIMETERS |       | INCHES |       |
|----------|-------------|-------|--------|-------|
|          | MIN         | MAX   | MIN    | MAX   |
| A        | 4.30        | 4.57  | 0.169  | 0.180 |
| A1       | 1.17        | 1.40  | 0.046  | 0.055 |
| A2       | 2.15        | 2.72  | 0.085  | 0.107 |
| b        | 0.65        | 0.86  | 0.026  | 0.034 |
| b1       | 0.95        | 1.40  | 0.037  | 0.055 |
| b2       | 0.95        | 1.15  | 0.037  | 0.045 |
| b3       | 0.65        | 1.15  | 0.026  | 0.045 |
| c        | 0.33        | 0.60  | 0.013  | 0.024 |
| D        | 14.81       | 15.95 | 0.583  | 0.628 |
| D1       | 8.51        | 9.45  | 0.335  | 0.372 |
| D2       | 12.19       | 13.10 | 0.480  | 0.516 |
| E        | 9.70        | 10.36 | 0.382  | 0.408 |
| E1       | 6.50        | 8.60  | 0.256  | 0.339 |
| e        | 2.54        |       | 0.100  |       |
| e1       | 5.08        |       | 0.200  |       |
| N        | 3           |       | 3      |       |
| H1       | 5.90        | 6.90  | 0.232  | 0.272 |
| L        | 13.00       | 14.00 | 0.512  | 0.551 |
| L1       | -           | 4.80  | -      | 0.189 |
| $\phi P$ | 3.60        | 3.89  | 0.142  | 0.153 |
| Q        | 2.60        | 3.00  | 0.102  | 0.118 |

**DOCUMENT NO.**  
Z8B00003318

**SCALE**

**EUROPEAN PROJECTION**

**ISSUE DATE**  
23-08-2007

**REVISION**  
05

PG-TO220-3-31 (FullPAK)

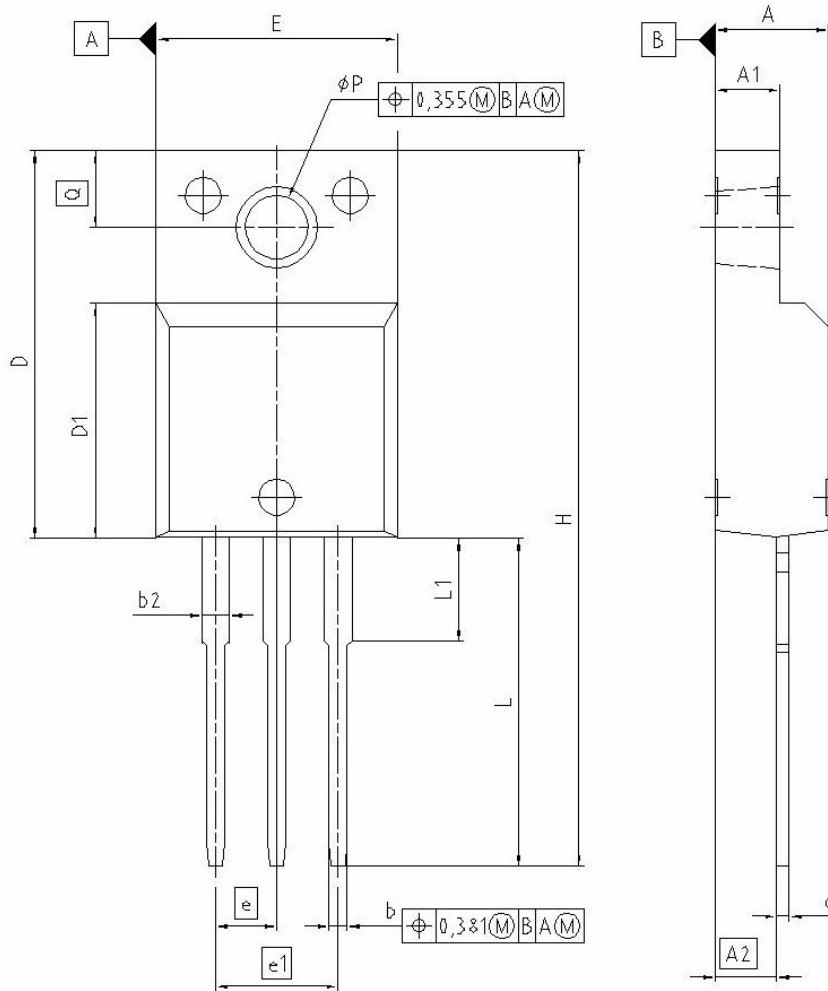

| DIM   | MILLIMETERS |        | INCHES |       |
|-------|-------------|--------|--------|-------|
|       | MIN         | MAX    | MIN    | MAX   |
| A     | 4.572       | 4.826  | 0.180  | 0.190 |
| A1    | 2.573       | 2.827  | 0.101  | 0.111 |
| A2    | 2.514       | 2.616  | 0.099  | 0.103 |
| b     | 0.649       | 0.776  | 0.025  | 0.030 |
| b2    | 1.143       | 1.509  | 0.045  | 0.059 |
| c     | 0.449       | 0.627  | 0.017  | 0.027 |
| D     | 15.863      | 16.117 | 0.624  | 0.634 |
| D1    | 9.554       | 9.808  | 0.376  | 0.386 |
| E     | 10.373      | 10.627 | 0.408  | 0.418 |
| e     | 2.540       |        | 0.100  |       |
| e1    | 5.080       |        | 0.200  |       |
| N     | 3           |        | 3      |       |
| H     | 29.463      | 29.717 | 1.160  | 1.170 |
| L     | 13.473      | 13.727 | 0.530  | 0.540 |
| L1    | 3.175       | 3.429  | 0.125  | 0.135 |
| phi P | 2.949       | 3.025  | 0.119  | 0.116 |
| Q     | 3.149       | 3.251  | 0.124  | 0.128 |

**REFERENCE**  
J..

**SCALE**

**EUROPEAN PROJECTION**

**ISSUE DATE**  
17-08-2005

**FILE**  
TO220\_2

**Published by**  
**Infineon Technologies AG**  
**81726 Munich, Germany**  
**© 2009 Infineon Technologies AG**  
**All Rights Reserved.**

**Legal Disclaimer**

The information given in this document shall in no event be regarded as a guarantee of conditions or characteristics. With respect to any examples or hints given herein, any typical values stated herein and/or any information regarding the application of the device, Infineon Technologies hereby disclaims any and all warranties and liabilities of any kind, including without limitation, warranties of non-infringement of intellectual property rights of any third party.

**Information**

For further information on technology, delivery terms and conditions and prices, please contact the nearest Infineon Technologies Office ([www.infineon.com](http://www.infineon.com)).

**Warnings**

Due to technical requirements, components may contain dangerous substances. For information on the types in question, please contact the nearest Infineon Technologies Office.

Infineon Technologies components may be used in life-support devices or systems only with the express written approval of Infineon Technologies, if a failure of such components can reasonably be expected to cause the failure of that life-support device or system or to affect the safety or effectiveness of that device or system. Life support devices or systems are intended to be implanted in the human body or to support and/or maintain and sustain and/or protect human life. If they fail, it is reasonable to assume that the health of the user or other persons may be endangered.