



# PJSD05LFN2

## ESD PROTECTION DIODES

### FEATURES

- IEC61000-4-2 Level 4 ESD Protection
- In compliance with EU RoHS 2002/95/EC directives

### MECHANICAL DATA

- Case: DFN 2L, Plastic
- Terminals: Solderable per MIL-STD-750, Method 2026
- Polarity : see cathode band

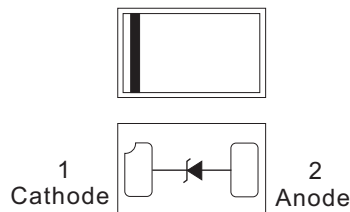

### DFN 2L Unit : inch(mm)

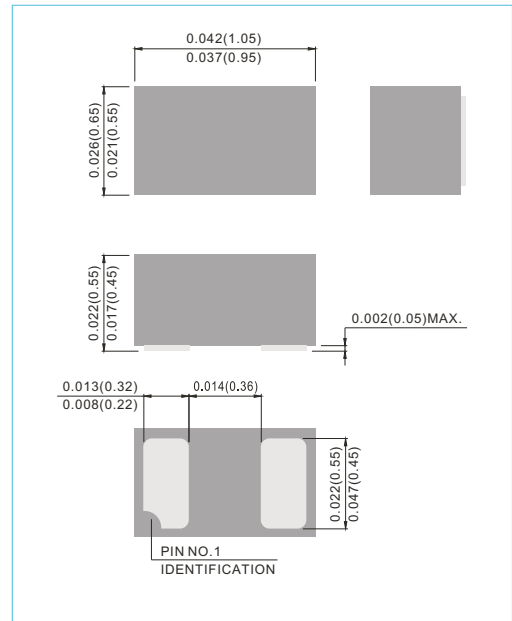

## MAXIMUM RATINGS

Rating	Symbol	Value	Units
Total Power Dissipation on FR-4 Board (Note 1) @ T <sub>A</sub> =25°C	P <sub>D</sub>	250	mW
Peak Power Dissipation 8/20 Surge Pulse	P <sub>PM</sub>	40	W
Thermal Resistance Junction to Ambient	R <sub>θJA</sub>	500	°C/W
Lead Solder Temperature-Maximum (10 Second Duration)	T <sub>L</sub>	260	°C
Operating Junction and Storage Temperature Range	T <sub>J</sub> , T <sub>STG</sub>	-55 to +150	°C

Stresses exceeding Maximum Ratings may damage the device. Maximum Rating are stress ratings only. Functional operation above the Recommended Operating Conditions is not implied. Extended exposure to stresses above the Recommended Operating Conditions may affect device reliability.

Note : 1.FR-4 = 70 x 60 x 1mm.

**PAN JIT RESERVES THE RIGHT TO IMPROVE PRODUCT DESIGN,FUNCTIONS AND RELIABILITY WITHOUT NOTICE**



# PJSD05LFN2

## ELECTRICAL CHARACTERISTICS (T<sub>A</sub>=25°C unless otherwise noted)

Parameter	Symbol
Maximum Reverse Peak Pulse Current	I <sub>PP</sub>
Clamping Voltage@I <sub>PP</sub>	V <sub>C</sub>
Working Peak Reverse Voltage	V <sub>RWM</sub>
Maximum Reverse Leakage Current@V <sub>RWM</sub>	I <sub>R</sub>
Breakdown Voltage @ I <sub>T</sub>	V <sub>BR</sub>
Test Current	I <sub>T</sub>
Forward Current	I <sub>F</sub>
Forward Voltage@I <sub>F</sub>	V <sub>F</sub>
Maximum Peak Power Dissipation	P <sub>PM</sub>
Max.Capacitance@V <sub>R</sub> =0 and f=1MHz	C

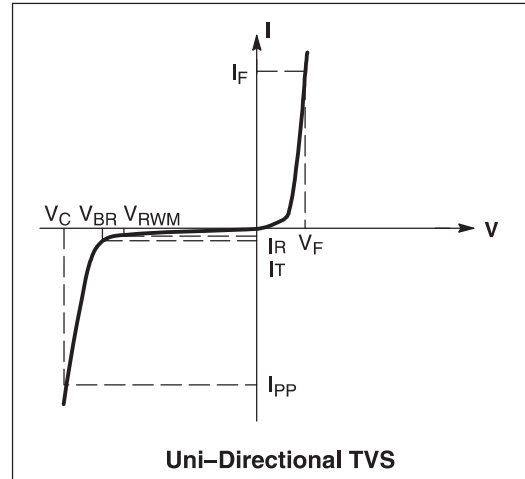

## ELECTRICAL CHARACTERISTICS (T<sub>A</sub>=25°C unless otherwise noted)

Part Number	V <sub>RWM</sub>	I <sub>R</sub> @V <sub>RWM</sub>	V <sub>BR</sub> @I <sub>T</sub> (Note 2)	C (Note 3)	V <sub>C</sub>	I <sub>PP</sub>	I <sub>T</sub>	Marking
	Max.	Max.	Min.	Max.	Max Per 8/20μs			
	V	μA	V	pF	V			
PJSD05LFN2	5	1	6.2	35	9.8	4	1.0	BC

Note : 2.V<sub>BR</sub> is measured with a pulse test current I<sub>T</sub> at an ambient temperature of 25°C

3.Capacitance at f=1MHz, V<sub>R</sub>=0V, T<sub>A</sub>=25°C



# PJSD05LFN2

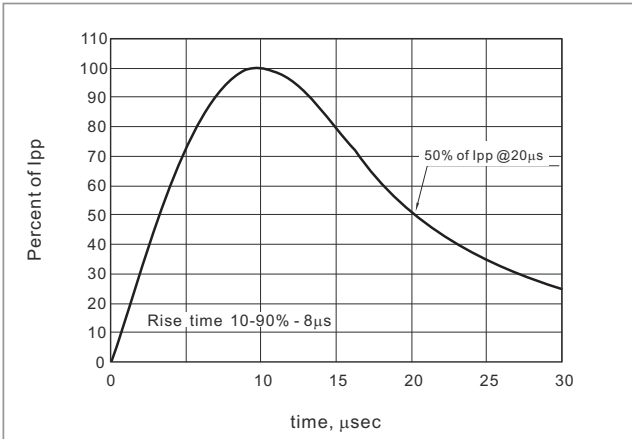

**Fig.1 8/20µs Peak Pulse Current Waveform**

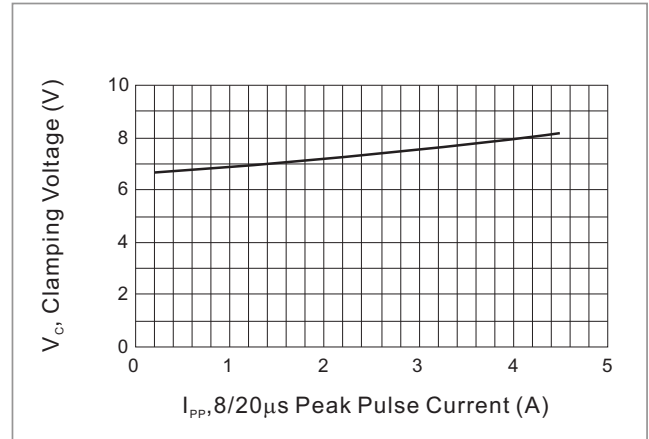

**Fig.2 Typical Peak Clamping Voltage**

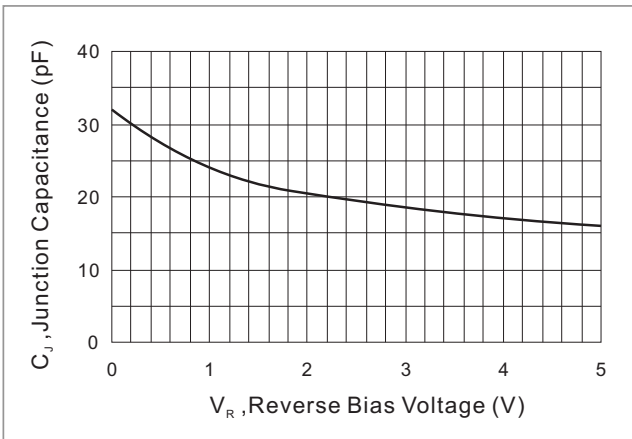

**Fig.3 Typical Junction Capacitance**

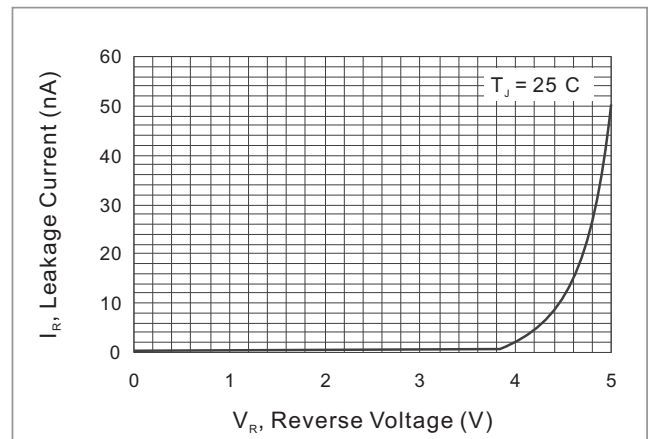

**Fig.4 Typical Reverse Characteristics**

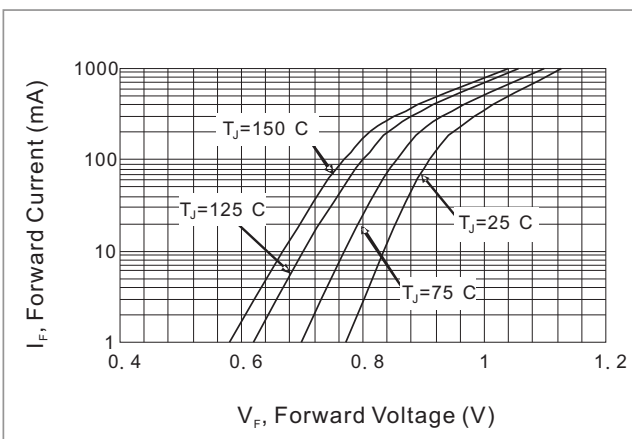

**Fig.5 Typical Forward Characteristics**

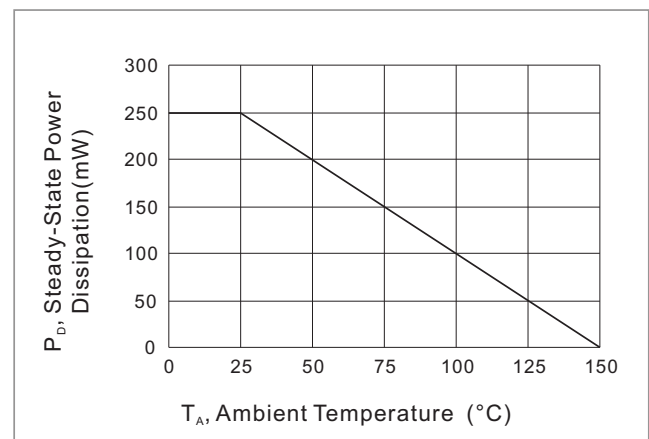
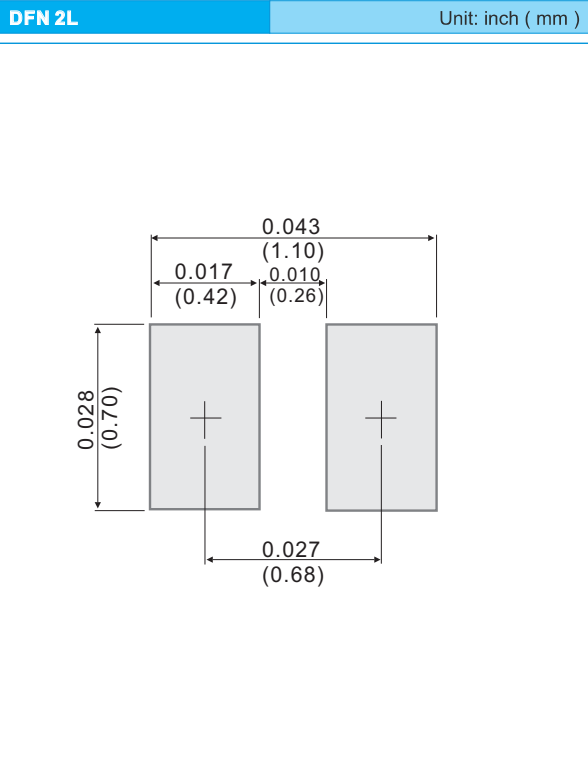

**Fig.6 Power Derating Curve**



# PJSD05LFN2

## MOUNTING PAD LAYOUT



## ORDER INFORMATION

- Packing information  
T/R - 8K per 7" plastic Reel

## LEGAL STATEMENT

### Copyright PanJit International, Inc 2010

The information presented in this document is believed to be accurate and reliable. The specifications and information herein are subject to change without notice. Pan Jit makes no warranty, representation or guarantee regarding the suitability of its products for any particular purpose. Pan Jit products are not authorized for use in life support devices or systems. Pan Jit does not convey any license under its patent rights or rights of others.