

Typical Applications

The HMC251MS8 is ideal for:

- Wireless Local Loop
- UNII & HiperLAN
- ISM
- VSAT

Features

Divide-By-Two

Low Phase Noise: -130 dBc/Hz @ 10KHz

Single Positive Bias Voltage: +5.0V @ 27 mA

Miniature Small Outline Package: MSOP8

Functional Diagram

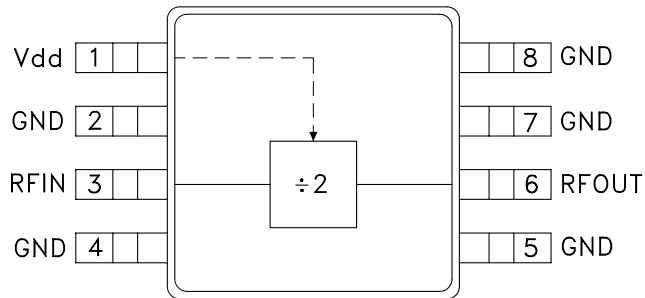

General Description

The HMC251MS8 is a low noise divide-by-2 GaAs MMIC prescaler in an 8 lead surface mount MSOP plastic package. This device operates from 3.0 to 6.5 GHz (input frequency) with a single +5.0 V DC supply while drawing only 27 mA of current. The low residual phase noise of this prescaler helps the user maintain good system noise performance.

Electrical Specifications, $T_A = +25^\circ C$, $V_{dd} = +5.0V$, 50 Ohm System

| Parameter | Condition | Min | Typical | Max | Units |
|---|--|-----|------------|-----|--------|
| Input Frequency Range | | | 3.0 - 6.5 | | GHz |
| Output Frequency Range | | | 1.5 - 3.25 | | GHz |
| Operating Input Power Range | Fin = 3.0 - 4.0 GHz | 6 | | 10 | dBm |
| | Fin = 4.0 - 5.0 GHz | -2 | | 10 | dBm |
| | Fin = 5.0 - 6.0 GHz | -8 | | 10 | dBm |
| | Fin = 6.0 - 6.5 GHz | -3 | | 7 | dBm |
| Output Power for Minimum Input Power Level (Note 1) | Fin = 3.0 - 4.0 GHz | -12 | -8.0 | -3 | dBm |
| | Fin = 4.0 - 5.0 GHz | -14 | -7.7 | -3 | dBm |
| | Fin = 5.0 - 6.0 GHz | -16 | -8.2 | -3 | dBm |
| | Fin = 6.0 - 6.5 GHz | -17 | -8.5 | -3 | dBm |
| Single-Side-Band Phase Noise | Fin = 5.0 - 6.0 GHz Offset from carrier = 10KHz | | -130 | | dBc/Hz |
| Supply Current (I _{dd}) | V _{dd} = -5.0 Vdc | | 27 | 33 | mA |

Note 1. Output Power Measured at half the Input Frequency.

**Output Power vs. Frequency
@ Minimum Input Power Level**

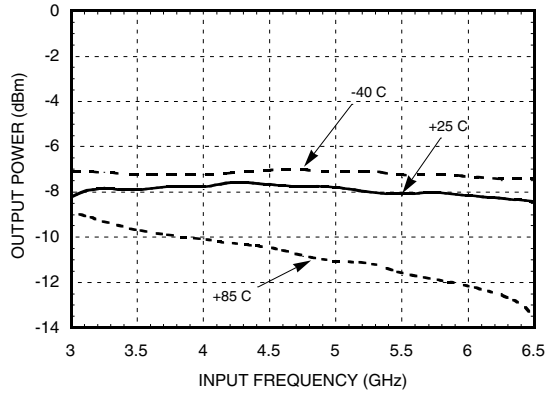

Minimum Input Power vs. Input Frequency

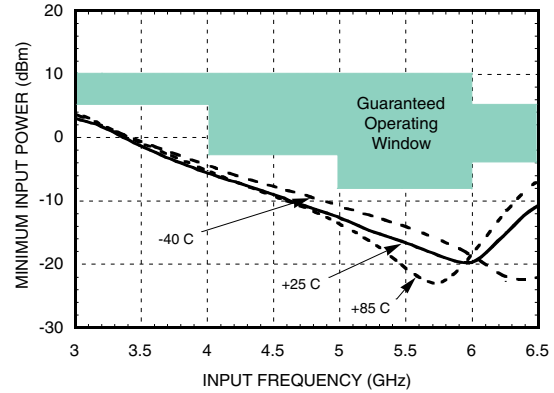

Output Power for Input Power= +10 dBm*

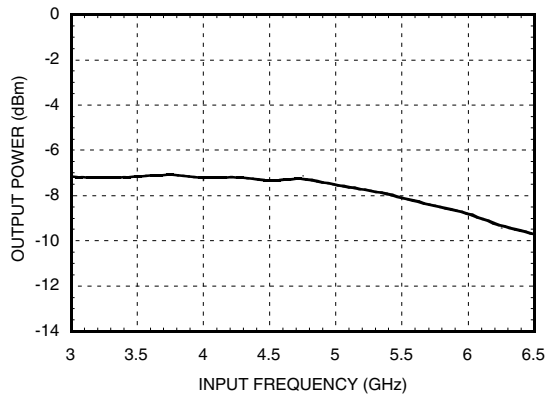

**Single-Side-Band Phase Noise
vs. Offset from Carrier, fin= 5 to 6 GHz**

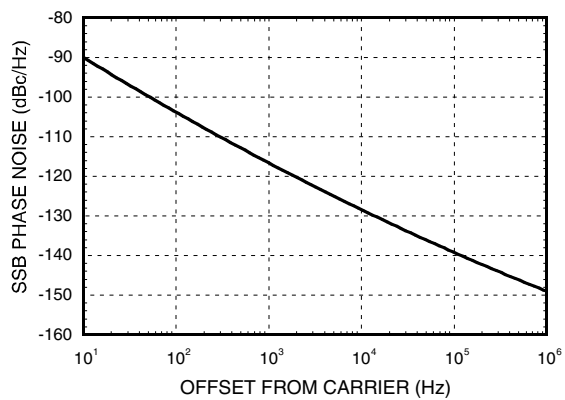

*Note: Output Power Measured @ $f_{in}/2$

**Output Power vs.
Input Power, Input Frequency= 5.2 GHz**

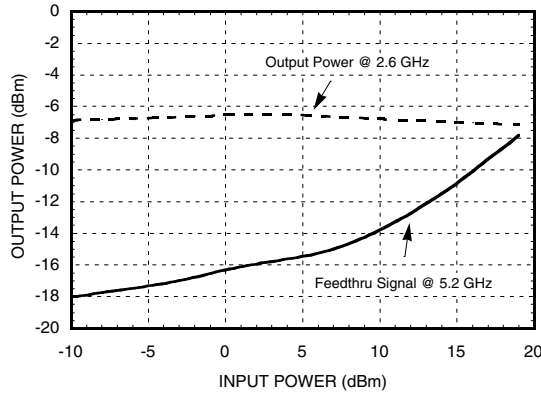

**Output Power vs.
Input Power, Input Frequency= 5.8 GHz**

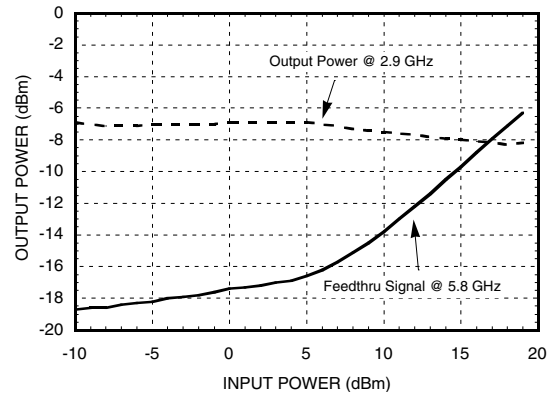

RF IN S-Parameters *

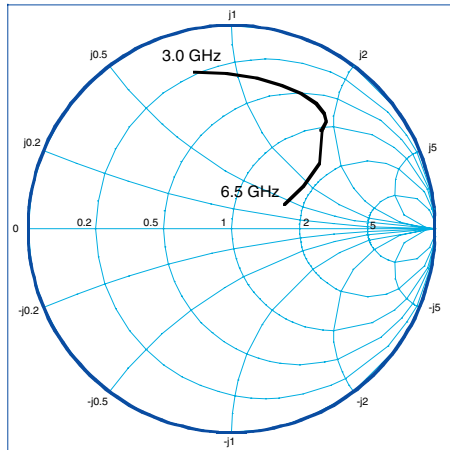

RF OUT S-Parameters *

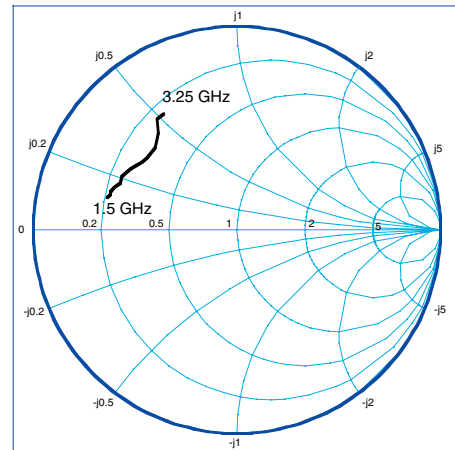

*S-Parameter Data is Available @ www.hittite.com

Absolute Maximum Ratings

| | |
|---|----------------|
| Vdd | +8 Vdc |
| Maximum Input Power (Vdd = +5.0 Vdc) | 20 dBm |
| Storage Temperature | -65 to +150 °C |
| Operating Temperature | -40 to +85 °C |



ELECTROSTATIC SENSITIVE DEVICE
OBSERVE HANDLING PRECAUTIONS

Outline Drawing

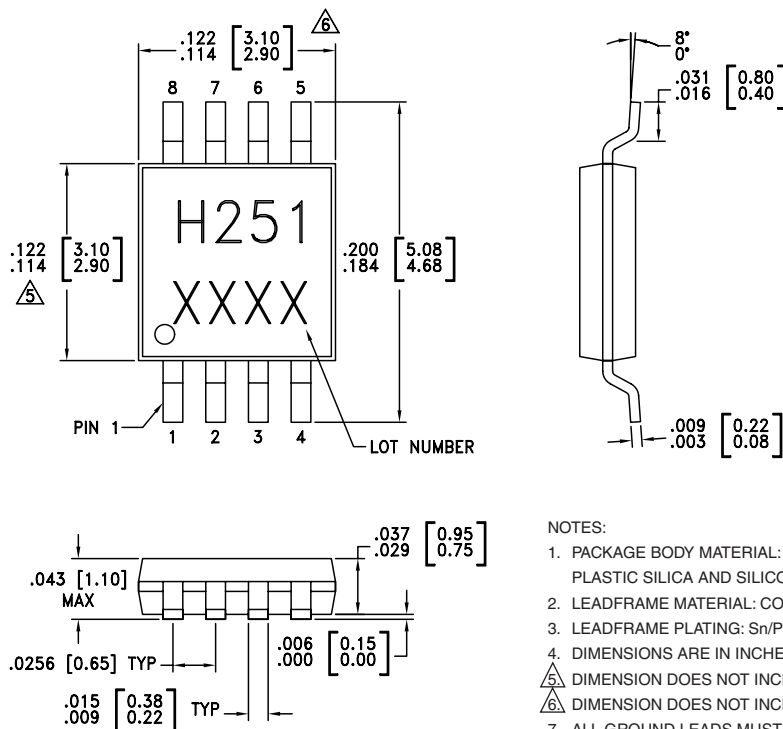

NOTES:

1. PACKAGE BODY MATERIAL: LOW STRESS INJECTION MOLDED PLASTIC SILICA AND SILICON IMPREGNATED.
2. LEADFRAME MATERIAL: COPPER ALLOY
3. LEADFRAME PLATING: Sn/Pb SOLDER
4. DIMENSIONS ARE IN INCHES [MILLIMETERS].
- △ DIMENSION DOES NOT INCLUDE MOLDFLASH OF 0.15mm PER SIDE.
- △ DIMENSION DOES NOT INCLUDE MOLDFLASH OF 0.25mm PER SIDE.
7. ALL GROUND LEADS MUST BE SOLDERED TO PCB RF GROUND.
8. CLASSIFIED AS MOISTURE SENSITIVITY LEVEL (MSL) 1.

Application Circuit

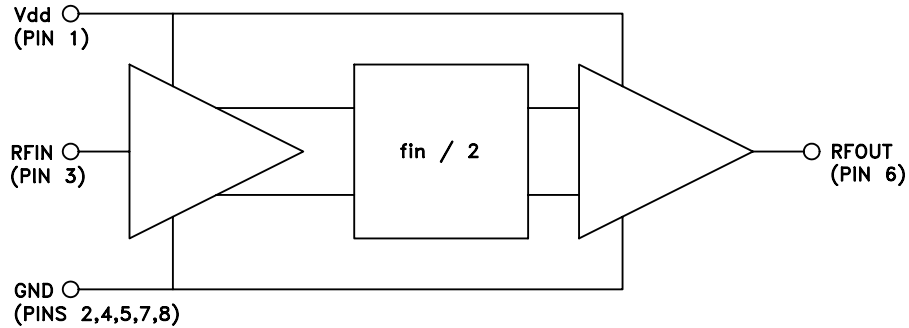

Operating Notes:

1. With no input signal, or input signals below the minimum input power level, the prescaler will self-oscillate.
2. DC blocks on the RF ports are not required but are recommended if DC voltages exceeding 8 volts are present.

Eval Board Layout (Top View)

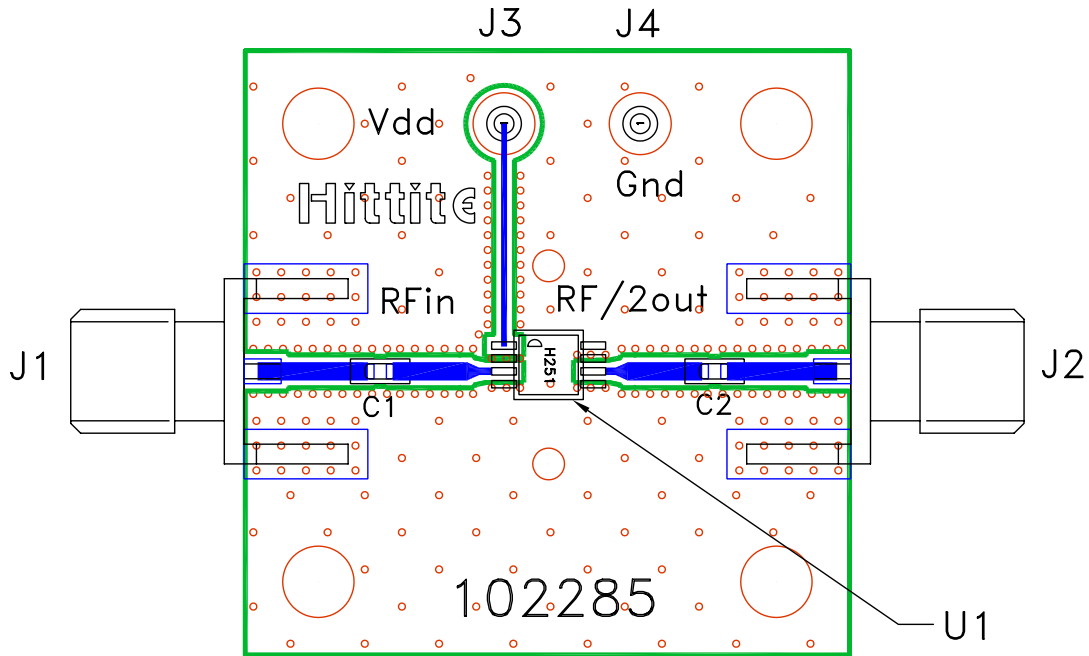

List Of Materials

| Item | Description |
|--------------------------------|-----------------------------|
| J1, J2 | PC Mount SMA Connector |
| J3, J4 | DC Pin |
| C1, C2 | 330 pF capacitor, 0603 Pkg. |
| U1 | HMC251MS8 Prescaler |
| PCB* | 102285 Eval Board |
| * Circuit Board Material: 4350 | |

The circuit board used in the final application should be generated with proper RF circuit design techniques. Signal lines at RF IN and RF OUT should have 50 ohm impedance and the package ground leads should be connected directly to the ground plane similar to that shown. The evaluation circuit board shown is available from Hittite upon request.