

4 Amps, 600Volts N-Channel MOSFET

■ Description

The ET4N60 N-Channel enhancement mode silicon gate power MOSFET is designed for high voltage, high speed power switching applications such as switching regulators, switching converters, solenoid, motor drivers, relay drivers.

■ Features

- $R_{DS(ON)} = 2.50\Omega @ V_{GS} = 10V$
- Low gate charge (typical 16nC)
- High ruggedness
- Fast switching capability
- Avalanche energy specified
- Improved dv/dt capability

■ Symbol

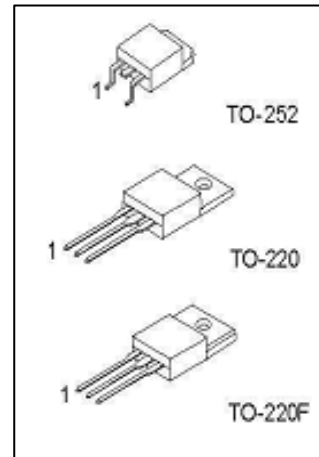
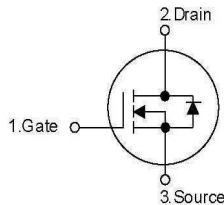

■ Absolute Maximum Ratings ($T_c = 25^\circ\text{C}$, unless otherwise specified)

Parameter		Symbol	Ratings			Units
			TO-220	TO-220F	TO-252	
Drain-Source Voltage		V_{DSS}	600			V
Gate-Source Voltage		V_{GSS}	± 30			V
Drain Current Continuous	$T_c = 25^\circ\text{C}$	I_D	4.0	4.0*	2.8	A
	$T_c = 100^\circ\text{C}$		2.4	2.4*	1.8	A
Drain Current Pulsed (Note 1)		I_{DP}	16	16*	11.2	A
Avalanche Energy	Repetitive (Note 1)	E_{AR}	10.4		4.9	mJ
	Single Pulse (Note 2)	E_{AS}	180		210	mJ
Peak Diode Recovery dv/dt (Note 3)		dv/dt	4.5			V/ns
Total Power Dissipation	$T_c = 25^\circ\text{C}$	P_D	104	34	49	W
	Derate above 25°C		0.83	0.27	0.39	W/ $^\circ\text{C}$

Junction Temperature	T_J	+150	°C
Storage Temperature	T_{STG}	-55~+150	°C

* Drain current limited by maximum junction temperature.

■ Thermal Characteristics

Parameter	Symbol	Ratings			Units
		TO-220	TO-220F	TO-252	
Thermal Resistance Junction-Ambient	R_{thJA}	62.5		50* (110)	°C/W
Thermal Resistance, Case-to-Sink Typ.	R_{thCS}	0.5	--	--	
Thermal Resistance Junction-Case	R_{thJC}	1.2	3.65	2.56	

■ Electrical Characteristics ($T_J=25^\circ\text{C}$, unless Otherwise specified.)

Parameter	Symbol	Test Conditions	Min	Typ	Max	Units	
Off Characteristics							
Drain-Source Breakdown Voltage	BV_{DSS}	$V_{GS}=0V, I_D=250\mu A$	600	--	--	V	
Zero Gate Voltage Drain Current	I_{DSS}	$V_{DS}=600V, V_{GS}=0V$	--	--	1	μA	
		$V_{DS}=480V, T_C=125^\circ\text{C}$	--	--	10	μA	
Gate-Body Leakage Current	Forward	I_{GSS}	$V_{GS}=30V, V_{DS}=0V$	--	--	100	nA
	Reverse					$V_{GS}=-30V, V_{DS}=0V$	--
Breakdown Voltage Temperature Coefficient	$\Delta BV_{DSS}/\Delta T_J$	$I_D=250\mu A$	--	0.7	--	V/°C	
On Characteristics							
Gate Threshold Voltage	$V_{GS(TH)}$	$V_{DS}=V_{GS}, I_D=250\mu A$	2.0	--	4.0	V	
Static Drain-Source On-Resistance	$R_{DS(ON)}$	$V_{DS}=10V,$ $I_D=2.0A(\text{TO220, TO220F})$ $I_D=1.4A(\text{TO252})$	--	2.0	2.5	Ω	
Dynamic Characteristics							
Input Capacitance	C_{ISS}	$V_{DS}=25V, V_{GS}=0V,$ $f=1\text{MHz}$	--	560	--	pF	
Output Capacitance	C_{OSS}		--	55	--	pF	
Reverse Transfer Capacitance	C_{RSS}		--	7	--	pF	
Switching Characteristics							
Turn-On Delay Time	$t_{D(ON)}$	$V_{DD}=300V,$ $I_D=4.0A(\text{TO220, TO220F})$ $I_D=2.8A(\text{TO252})$ $R_G=25\Omega$ (Note 4, 5)	--	10	--	ns	
Rise Time	t_R		--	40	--	ns	
Turn-Off Delay Time	$t_{D(OFF)}$		--	40	--	ns	
Fall Time	t_F		--	50	--	ns	
Total Gate Charge	Q_G	$V_{DS}=480V,$ $I_D=4.0A(\text{TO220, TO220F})$ $I_D=2.8A(\text{TO252})$ $V_{GS}=10V$ (Note 4, 5)	--	16	--	nC	
Gate-Source Charge	Q_{GS}		--	2.5	--	nC	
Gate-Drain Charge	Q_{GD}		--	6.5	--	nC	
Drain-Source Diode Characteristics							
Drain-Source Diode Forward Voltage	V_{SD}	$V_{GS}=0V$ $I_{SD}=4.0A(\text{TO220, TO220F})$ $I_{SD}=2.8A(\text{TO252})$	--	--	1.4	V	
Continuous Drain-Source Current	I_{SD}	TO-220, TO-220F	--	--	4.0	A	
		TO-252	--	--	2.8		
Pulsed Drain-Source Current	I_{SM}	TO-220, TO-220F	--	--	16.0	A	
		TO-252	--	--	11.2		
Reverse Recovery Time	t_{RR}	$I_{SD}=4.0A,$ $dI_{SD}/dt=100A/\mu s$ (Note 4)	--	300	--	ns	
Reverse Recovery Charge	Q_{RR}		--	2.0	--	μC	

1. Repetitive Rating : Pulse width limited by maximum junction temperature
2. $L = 20 \text{ mH}, I_{AS} = 4.0 \text{ A}, V_{DD} = 50V, R_G = 25 \Omega$, Starting $T_J = 25^\circ\text{C}$
3. $I_{SD} \leq 4.0 \text{ A}, di/dt \leq 200A/\mu s, V_{DD} \leq BV_{DSS}$, Starting $T_J = 25^\circ\text{C}$
4. Pulse Test : Pulse width $\leq 300 \mu s$, Duty cycle $\leq 2\%$
5. Essentially independent of operating temperature

■ Typical Characteristics

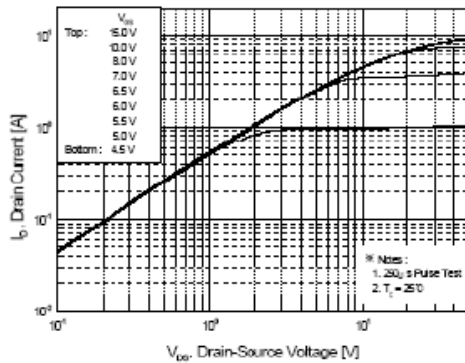

Figure 1. On-Region Characteristics

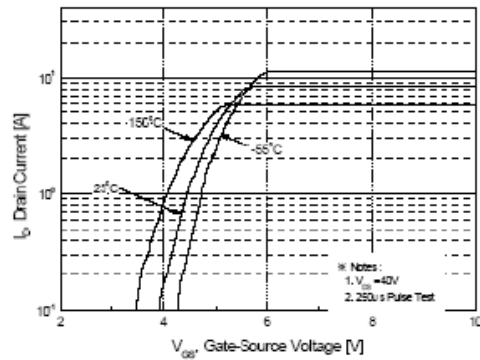

Figure 2. Transfer Characteristics

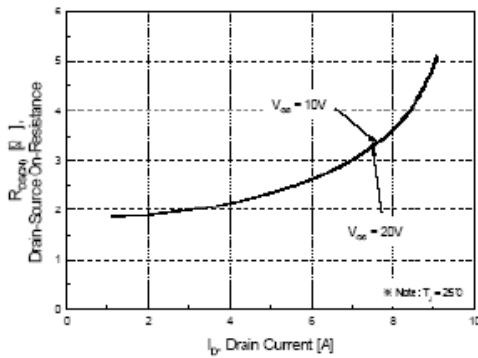

Figure 3. On-Resistance Variation vs Drain Current and Gate Voltage

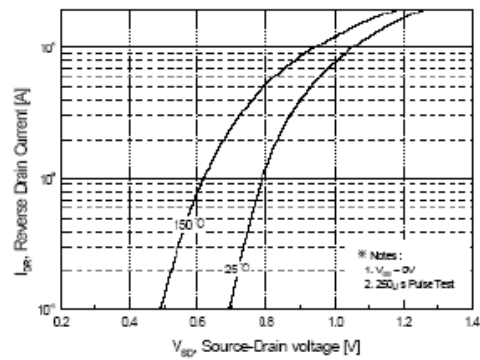

Figure 4. Body Diode Forward Voltage Variation with Source Current

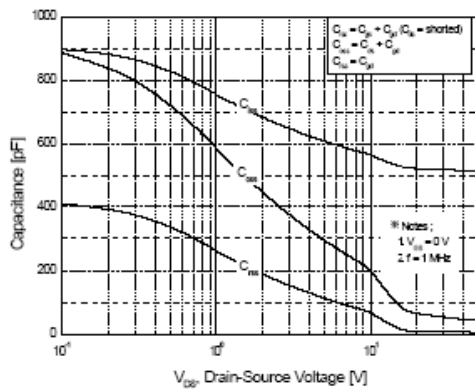

Figure 5. Capacitance Characteristics

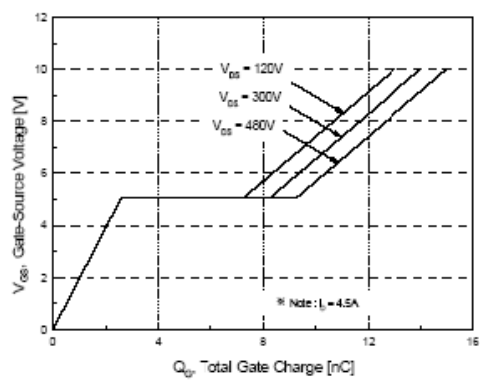

Figure 6. Gate Charge Characteristics

■ Typical Characteristics (Continued)

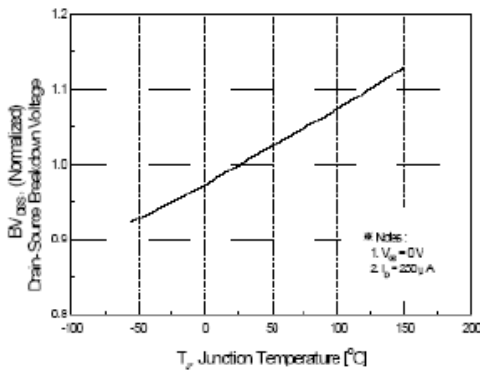

Figure 7. Breakdown Voltage Variation vs Temperature

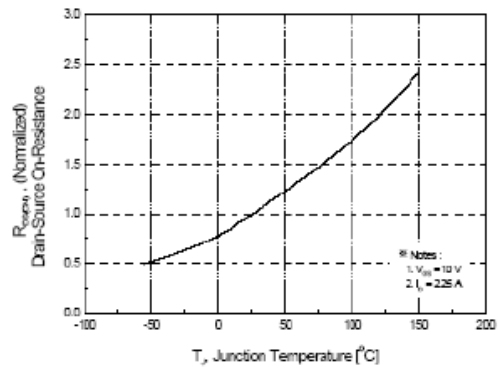

Figure 8. On-Resistance Variation vs Temperature

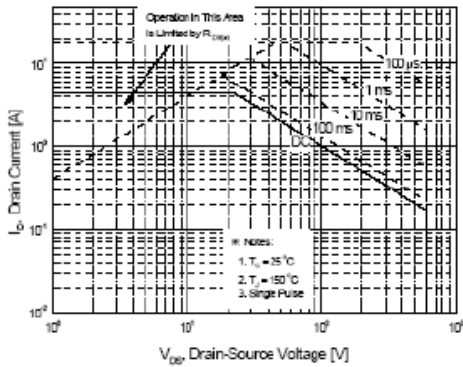

Figure 9-1. Maximum Safe Operating Area for TO220

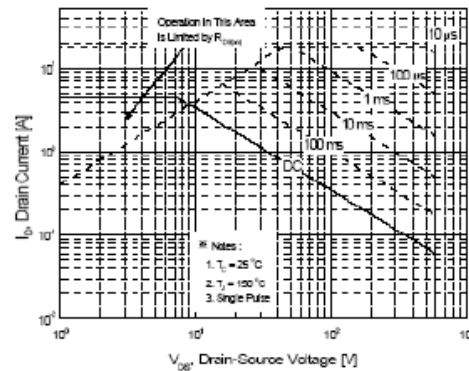

Figure 9-2. Maximum Safe Operating Area for TO220F

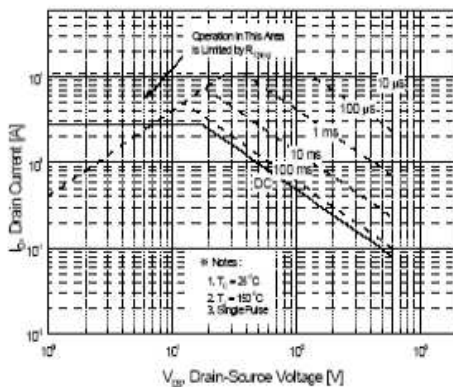

Figure 9-3. Maximum Safe Operating Area for TO251, TO252

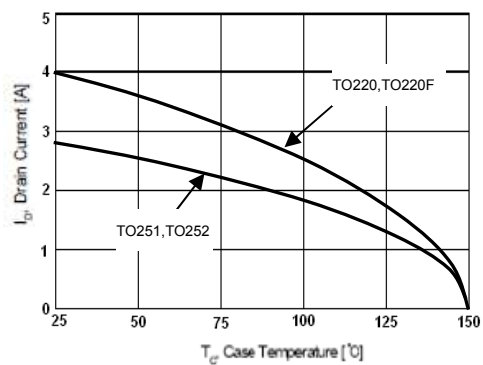
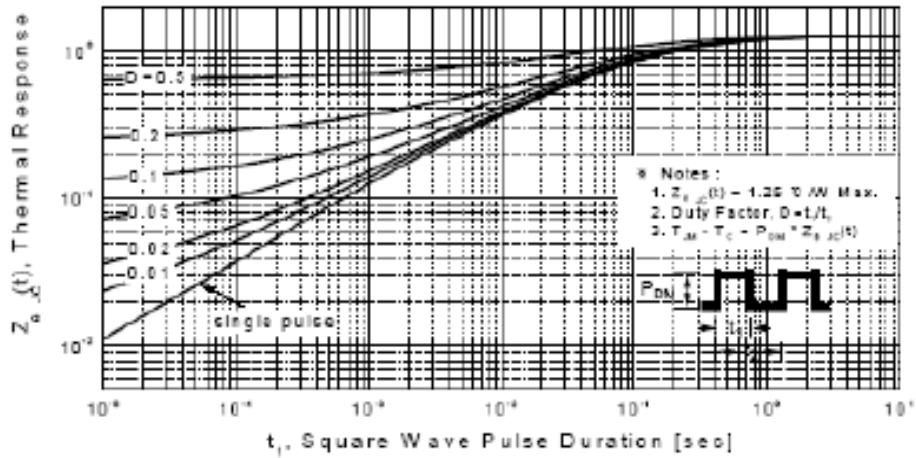
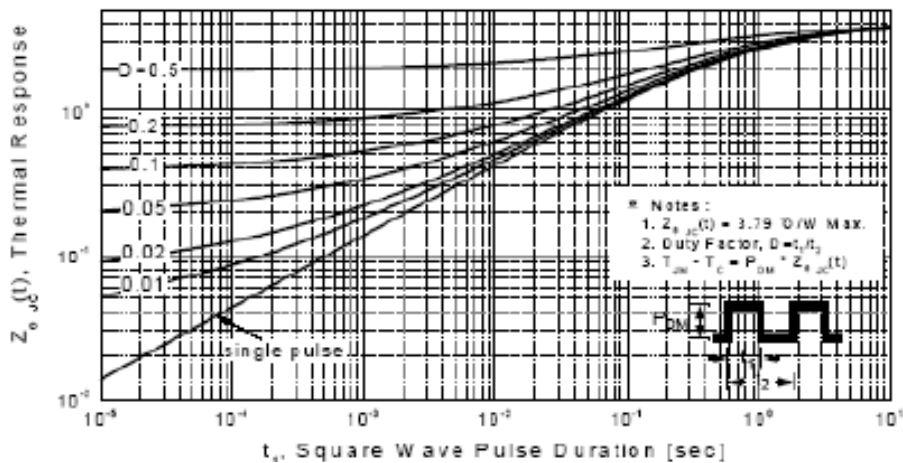
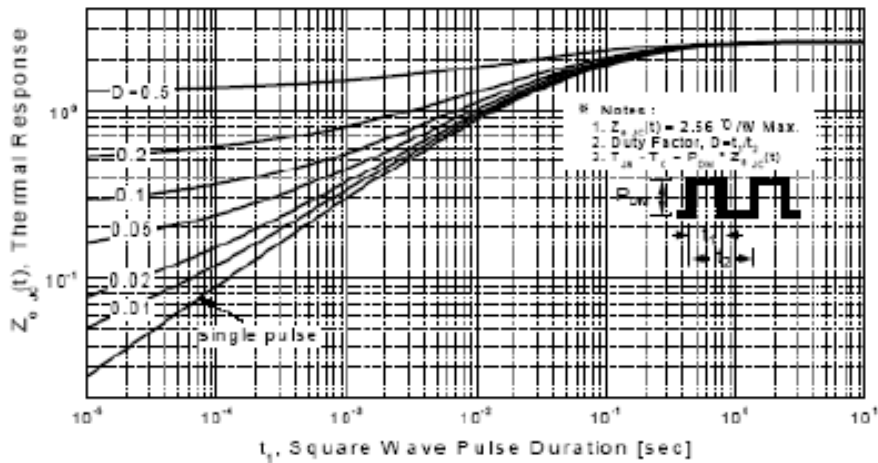

Figure 10. Maximum Drain Current vs Case Temperature

Typical Characteristics (Continued)

Figure 11-1. Transient Thermal Response Curve TO220

Figure 11-2. Transient Thermal Response Curve for TO220F

Figure 11-3. Transient Thermal Response Curve for TO252