

1N60PW, 1N60SW

Schottky Barrier Diode

FEATURES

- High reliability
- Low forward voltage and reverse current

APPLICATIONS

- For electronic calculator, etc.
- Low current rectification and high speed switching

PINNING

PIN	DESCRIPTION
1	Cathode
2	Anode

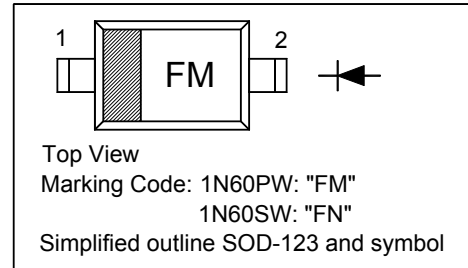

Absolute Maximum Ratings ($T_a = 25\text{ }^\circ\text{C}$)

Parameter	Symbol	Value	Unit
Peak Reverse Voltage	V_{RM}	45	V
Reverse Voltage	V_R	10	V
Peak Forward Current	I_{FM}	150	mA
Average Rectified Output Current	I_O	50	mA
Surge Forward Current	I_{surge}	500	mA
Junction Temperature	T_j	125	$^\circ\text{C}$
Storage Temperature Range	T_S	-55 to +125	$^\circ\text{C}$

Characteristics ($T_a = 25\text{ }^\circ\text{C}$)

Parameter	Symbol	Min.	Max.	Unit
Forward Current at $V_F = 1\text{ V}$	I_F	4	-	mA
Reverse Current at $V_R = 10\text{ V}$	I_R	-	50	μA
		-	100	
Reverse Voltage at $I_R = 100\text{ }\mu\text{A}$	V_R	45	-	V
Junction Capacitance at $f = 1\text{ MHz}$, $V = -1\text{ V}$	C_J	-	1	pF
Rectification efficiency at $V_i = 2\text{ V}_{rms}$, $R = 5\text{ K}\Omega$, $C = 20\text{ pF}$, $f = 40\text{ MHz}$	η	55	-	%

Pair $\Delta I_F \leq 6\text{ mA}$ at 1V, $\Delta I_R \leq 20\text{ }\mu\text{A}$ at 10 V

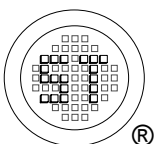

SEMTECH ELECTRONICS LTD.

(Subsidiary of Sino-Tech International Holdings Limited, a company listed on the Hong Kong Stock Exchange, Stock Code: 724)

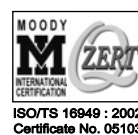

ISO/TS 16949 : 2002
Certificate No. 05103

ISO 14001:2004
Certificate No. 7116

ISO 9001:2000
Certificate No. 0506098

Dated : 07/04/2006

1N60PW, 1N60SW

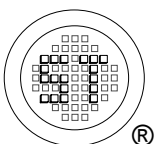
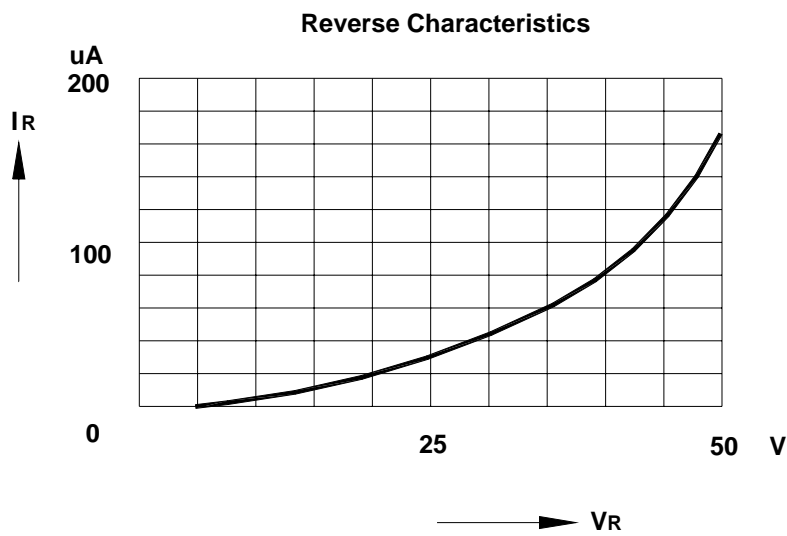
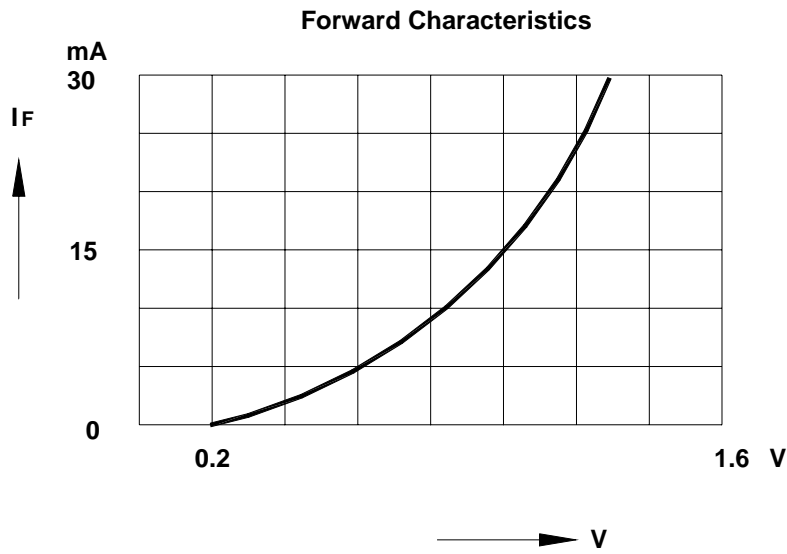

SEMTECH ELECTRONICS LTD.
(Subsidiary of Sino-Tech International Holdings Limited, a company listed on the Hong Kong Stock Exchange, Stock Code: 724)



Dated : 07/04/2006

1N60PW, 1N60SW

PACKAGE OUTLINE

Plastic surface mounted package; 2 leads

SOD-123

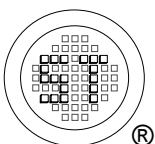
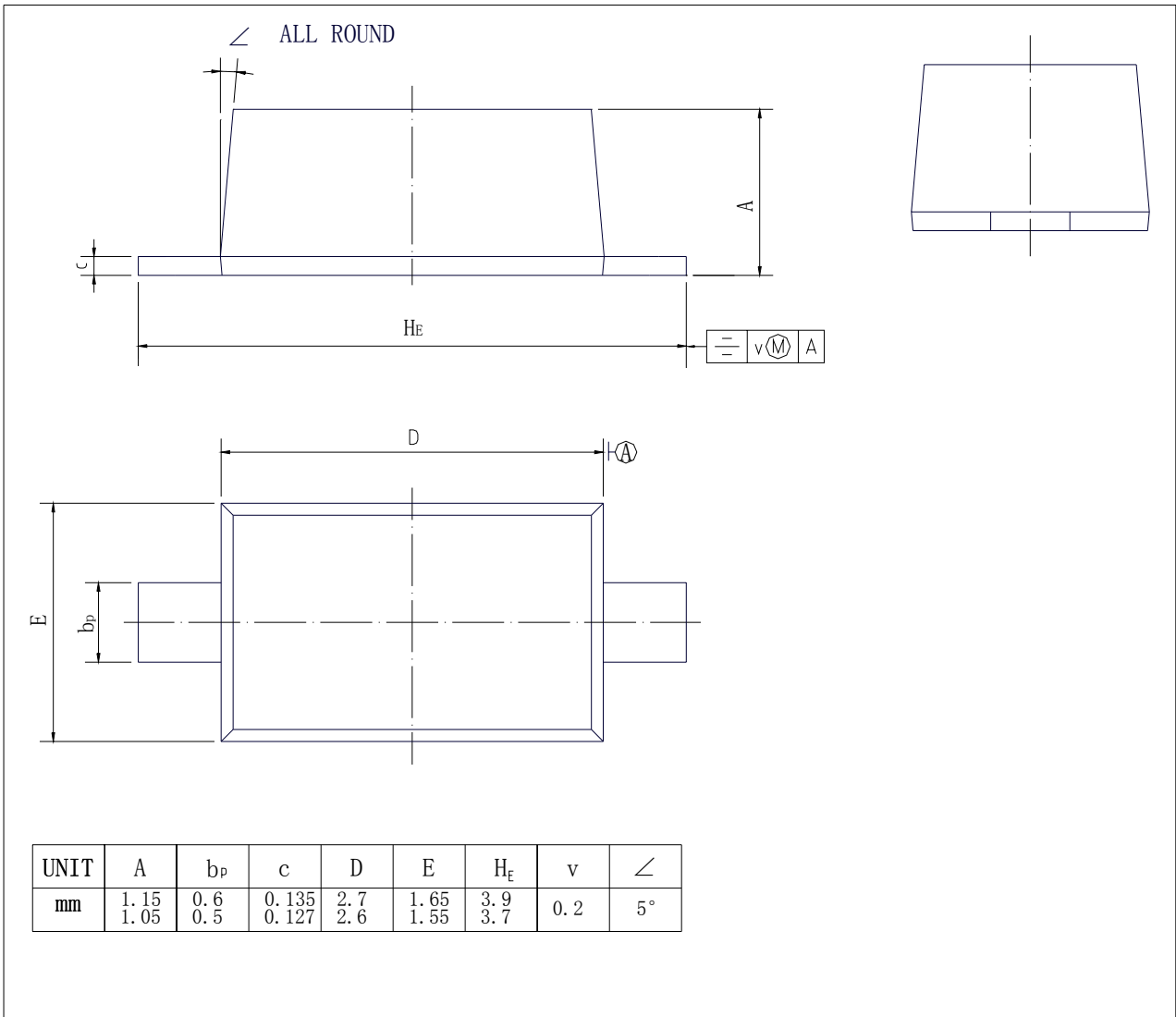

SEMTECH ELECTRONICS LTD.

(Subsidiary of Sino-Tech International Holdings Limited, a company listed on the Hong Kong Stock Exchange, Stock Code: 724)



ISO/TS 16949 : 2002
Certificate No. 05103



ISO 14001:2004
Certificate No. 7116



ISO 9001:2000
Certificate No. 0506098

Dated : 07/04/2006