

RoHS Compliant Product

Description

The SSC2156 positive, linear regulators feature low ground current (30µA typ.) with low dropout voltage, making them ideal for battery applications. The space-saving SOP-8 package is attractive for "Pocket" and "Hand Held" applications. These rugged devices have both Thermal Shutdown and Current Fold-back to prevent device failure under the "Worst" of operating conditions. The SSC2156 is stable with an output capacitance of 2.2µF or greater.

Features

- * Low Temperature Coefficient
- * Over-Temperature Shutdown
- * User Adjustable Output Voltages
- * Very Low Dropout Voltage
- * Accurate to within 1.5%
- * Guaranteed 600mA output
- * Current Limiting
- * Power-Saving Shutdown Mode
- * Short Circuit Current Fold-back

Applications

- * PC Peripherals
- * Wireless Devices
- * Portable Electronics
- * Battery Powered Widgets
- * Instrumentation
- * Cordless Phones

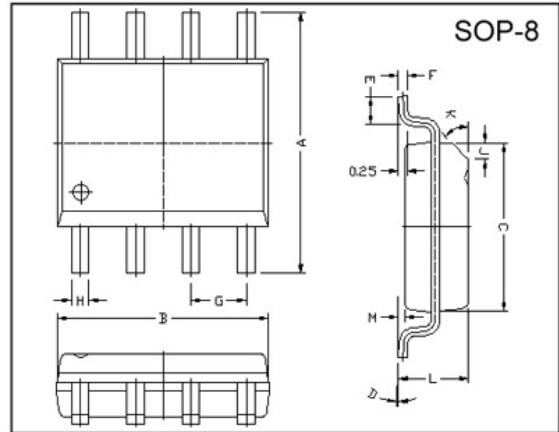

REF.	Millimeter		REF.	Millimeter	
	Min.	Max.		Min.	Max.
A	5.80	6.20	M	0.10	0.25
B	4.80	5.00	H	0.35	0.49
C	3.80	4.00	L	1.35	1.75
D	0"	8"	J	0.375 REF.	
E	0.40	0.90	K	45°	
F	0.19	0.25	G	1.27 TYP.	

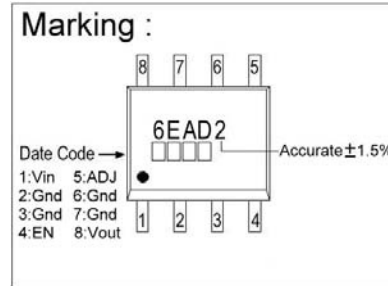

Functional Block Diagram

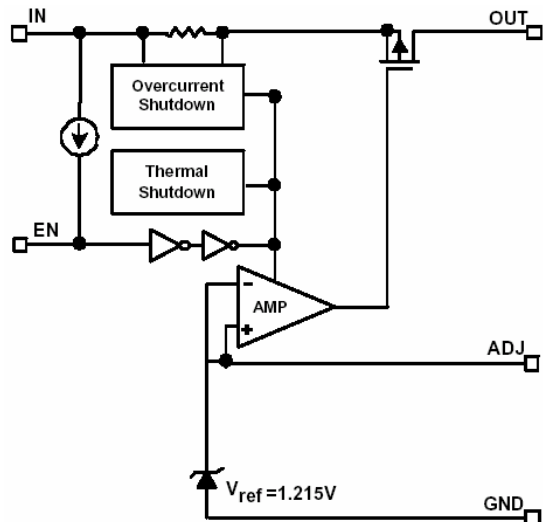

Typical Application Circuit

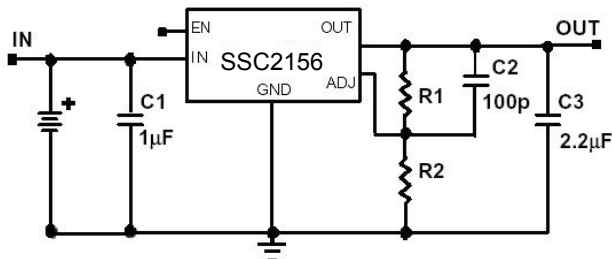

$$V_{OUT} = 1.215 * (1 + R1/R2)$$

C2 is unnecessary if R1 or R2 < 20KΩ

R1 and R2 use resistance value within 1% accuracy for correct V_{OUT}

Absolute Maximum Ratings

Parameter	Symbol	Ratings	Unit
Input Voltage	V_{IN}	8	V
Output Current	I_{OUT}	$P_D/(V_{IN}-V_O)$	mA
Output Voltage	V_{OUT}	Gnd-0.3 to $V_{IN}+0.3$	V
Operating Ambient Temperature	T_{opr}	-40~+85	°C
Junction Temperature	T_j	-40~+125	°C
Max. Junction Temperature	$T_j \text{ Max.}$	150	°C
Power Dissipation ($\Delta T=100^\circ\text{C}$)	P_D	810	mW
EDS Classification		B	

Electrical Characteristics $T_a=25^\circ\text{C}$ unless otherwise noted

Parameter	Symbol	Min.	Typ.	Max.	Unit	Condition
Output Voltage	$V_{OUT(E)}^1$	-1.5%	$V_{OUT(T)}^2$	1.5%	V	$I_O=1\text{mA}, V_{IN}=V_{OUT(T)}+2\text{V}$
Output Current	I_O	600	-	-	mA	$V_O>1.2\text{V}$
Current Limit	I_{LIM}	600	800	-	mA	$V_O>1.2\text{V}$
Load Regulation	REG_{LOAD}	-	0.2	1	%	$V_{IN}=V_{OUT(T)}+2\text{V}, I_O=1\text{mA}\sim 600\text{mA}$
Dropout Voltage	$V_{DROPOUT}$	-	-	1400	mV	$1.5\text{V}<V_{OUT(T)}\leq 2.0\text{V}$
		-	-	800		$2.0\text{V}<V_{OUT(T)}\leq 2.8\text{V}$
		-	-	600		$2.8\text{V}<V_{OUT(T)}$
						$I_O=600\text{mA}$ $V_O=V_{OUT(E)}-2\%$
Ground Pin Current	I_{GND}	-	30	-	uA	$V_{IN}=V_{OUT(T)}+2\text{V}, I_O=1\text{mA}\sim 600\text{mA}$
Line Regulation	REG_{LINE}	-	-	0.15	%	$V_{OUT(T)}< 2.0\text{V}$
		-	0.02	0.1		$2.0\text{V}\geq V_{OUT(T)}$
						$I_O=1\text{mA}$ $V_{IN}=V_{OUT(T)}+1$ to $V_{OUT(T)}+2$
Input Voltage	V_{IN}	Note ³	-	7	V	
Over Temperature Shutdown	O_{TS}	-	150	-	°C	
Over Temperature Hysteresis	O_{TH}	-	30	-	°C	
Output Voltage Temperature Coefficient	T_C	-	30	-	ppm/°C	
Power Supply Rejection	PSRR	-	50	-	dB	f=1kHz
		-	20	-		f=10kHz
		-	15	-		f=100kHz
						$I_O=100\text{mA}$ $C_O=2.2\mu\text{F}$
Output Voltage Noise	eN	-	30	-	uVrms	f=10Hz~100kHz, $I_O=10\text{mA}$ $C_O=2.2\mu\text{F}$
EN Input Threshold	V_{EH}	2	-	V_{IN}	V	$V_{IN}=2.7\text{V}$ to 7V
	V_{EL}	0	-	0.4		
EN Input Bias Current	I_{EH}	-	-	0.1	uA	$V_{EN}=V_{IN}, V_{IN}=2.7\text{V}\sim 7\text{V}$
	I_{EL}	-	-	0.5		$V_{EN}=0\text{V}, V_{IN}=2.7\text{V}\sim 7\text{V}$
Short Circuit Current	I_{SC}	-	30	-		$V_{IN}=V_{OUT(T)}+1\text{V}, V_O<0.8\text{V}$
Shutdown Supply Current	I_{SD}	-	300	600	mA	$V_{IN}=5\text{V}, V_O=0, V_{EN}<V_{EL}$
ADJ Reference Voltage	V_{REF}	1.203	1.215	1.227	V	

Note 1: $V_{OUT(E)}$ =Effective Output Voltage (i.e. the output voltage when " $V_{OUT(T)}+2.0\text{V}$ " is provided at the V_{IN} pin while maintaining a certain I_{OUT} value).

2: $V_{OUT(T)}$ =Specified Output Voltage

3: $V_{IN(MIN)}=V_{OUT}+V_{DROPOUT}$

Ordering Information(contd.)

Part Number	Marking	Output Voltage	Part Number	Marking	Output Voltage
SSC2156-AD	6EAD2 XXXX	Adjustable			

Detailed Description

The SSC2156 of COMS regulators contain a PMOS pass transistor, voltage reference, error amplifier, over-current protection and thermal shutdown. The P-channel pass transistor receives data from the error amplifier, over-current shutdown, and thermal protection circuits. During normal operation, the error amplifier compares the output voltage to a precision reference. Over-current and Thermal shutdown circuits become active when the junction temperature exceeds 150°C, or the current exceeds 600mA. During thermal shutdown, the output voltage remains low. Normal operation is restored when the junction temperature drops below 120° C. The SSC2156 switches from voltage mode when the load exceeds the rated output current. This prevents over-stress. The SSC2156 also incorporates current fold-back to reduce power dissipation when the output is short circuited. This feature becomes active when the output drops below 0.8V, and reduces the current flow by 65%. Full current is restored when the voltage exceeds 0.8V.

External Capacitors

The SSC2156 is stable with an output capacitance to ground of 2.2uF or greater. Ceramic capacitors have the lowest ESR, and will offer the best AC performance. Conversely, Aluminum Electrolytic capacitors exhibit the highest ESR, resulting in the poorest AC response. Unfortunately, large value ceramic capacitors are comparatively expensive. One option is to parallel a 0.1uF ceramic capacitor with a 10uF Aluminum Electrolytic. The benefit is low ESR, high capacitance, and low overall cost. A second capacitor is recommended between the input and ground to stabilize V_{IN} . The input capacitor should be at least 0.1uF to have a beneficial effect. All capacitors should be placed in closed proximity to the pins. A "Quiet" ground termination is desirable. This can be achieved with a "Star" connection.

Enable

The Enable pin normally floats high. When actively, pulled low, the PMOS pass transistor shuts off, and all internal circuits are powered down. In this state, the quiescent current is less than 1uA. This pin behaves much like an electronic switch.

ADJ

The ADJ pin is the positive input to the error amplifier which, due to the PMOS pass element inversion, means it is actually the negative input of the LDO feedback loop. The feedback works to keep the voltage at the ADJ pin 1.215V with respect to ground. Since the internal circuitry at the ADJ pin is essentially an ESD protected CMOS gate the input current at the ADJ pin is virtually zero.

Characteristics Curve

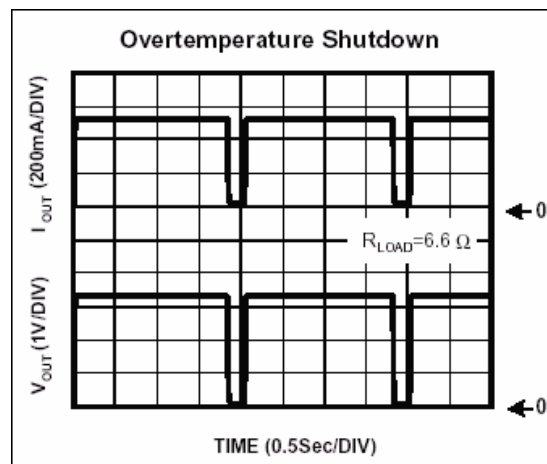
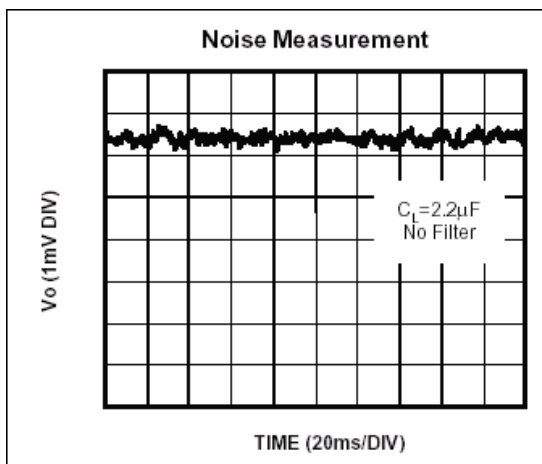
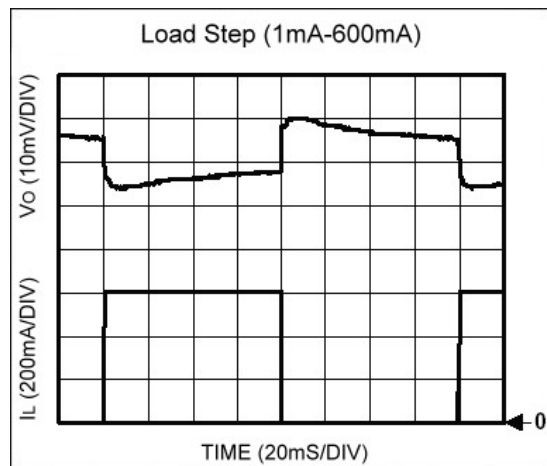
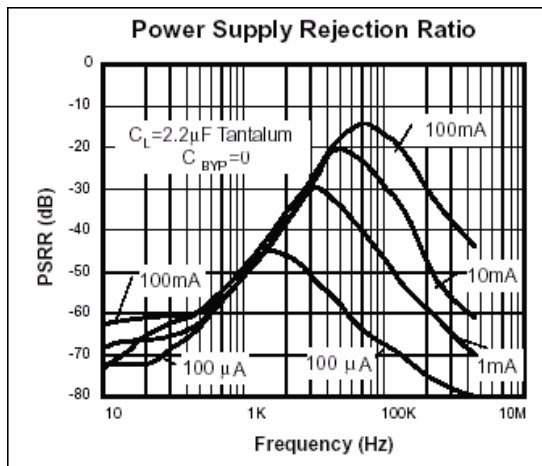
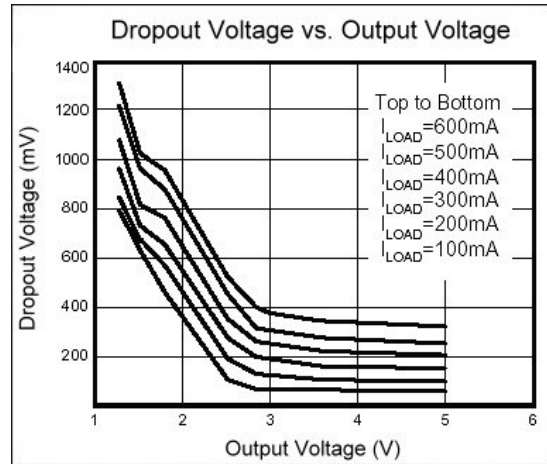
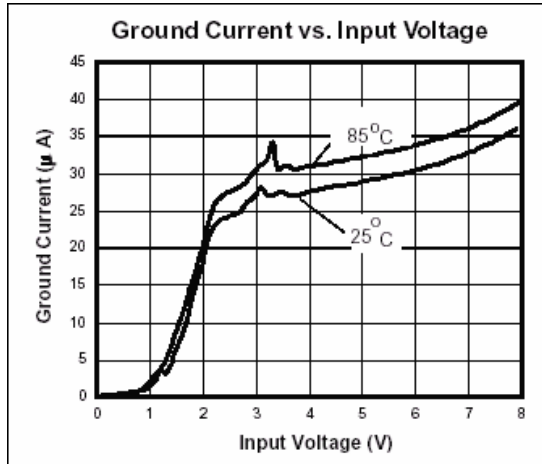

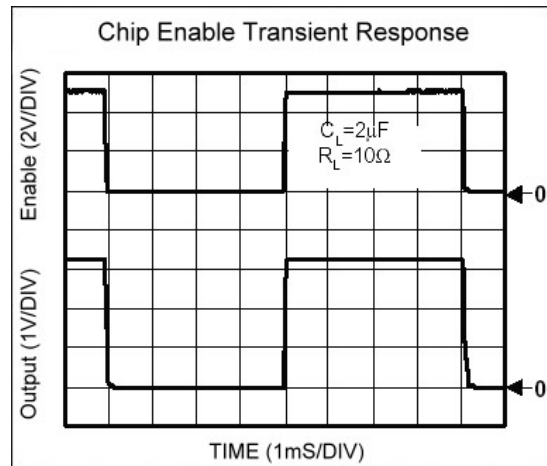
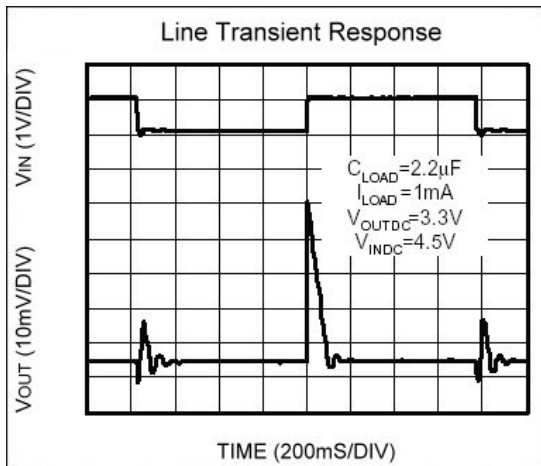
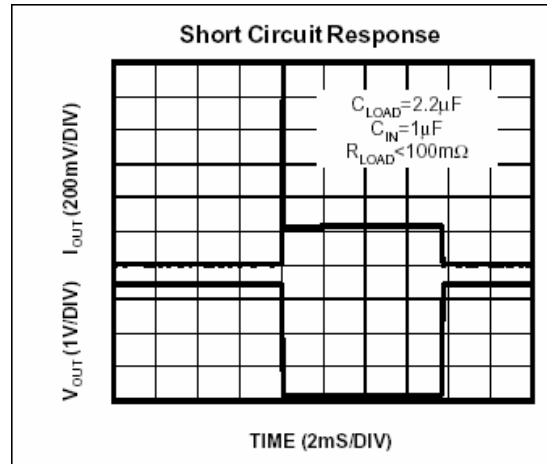
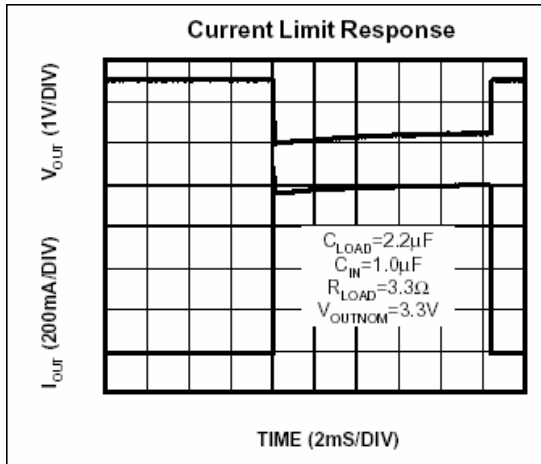



Elektronische Bauelemente

SSC2156

600mA CMOS

Positive Voltage Regulator

External Resistor Divider Table

R1(K Ohm)	1	2	3	4	5	6	7	8	9	10
Vout	$R2(K\ Ohm)=(1.215*R1(K\ Ohm))/(V_{out}-1.215)$									
1.30	14.29	28.59	42.88	57.18	71.47	85.76	100.06	114.35	128.65	142.94
1.35	9.00	18.00	27.00	36.00	45.00	54.00	63.00	72.00	81.00	90.00
1.40	6.57	13.14	19.70	26.27	32.84	39.41	45.97	52.54	59.11	65.68
1.45	5.17	10.34	15.51	20.68	25.85	31.02	36.19	41.36	46.53	51.70
1.50	4.26	8.53	12.79	17.05	21.32	25.58	29.84	34.11	38.37	42.63
1.55	3.63	7.25	10.88	14.51	18.13	21.76	25.39	29.01	32.64	36.27
1.60	3.16	6.31	9.47	12.62	15.78	18.94	22.09	25.25	28.40	31.56
1.65	2.79	5.59	8.38	11.17	13.97	16.76	19.55	22.34	25.14	27.93
1.70	2.51	5.01	7.52	10.02	12.53	15.03	17.54	20.04	22.55	25.05
1.75	2.27	4.54	6.81	9.08	11.36	13.63	15.90	18.17	20.44	22.71
1.80	2.08	4.15	6.23	8.31	10.38	12.46	14.54	16.62	18.69	20.77
1.85	1.91	3.83	5.74	7.65	9.57	11.48	13.39	15.31	17.22	19.13
1.90	1.77	3.55	5.32	7.09	8.87	10.64	12.42	14.19	15.96	17.74
1.95	1.65	3.31	4.96	6.61	8.27	9.92	11.57	13.22	14.88	16.53
2.00	1.55	3.10	4.64	6.19	7.74	9.29	10.83	12.38	13.93	15.48
2.05	1.46	2.91	4.37	5.82	7.28	8.73	10.19	11.64	13.10	14.55
2.10	1.37	2.75	4.12	5.49	6.86	8.24	9.61	10.98	12.36	13.73
2.15	1.30	2.60	3.90	5.20	6.50	7.80	9.10	10.40	11.70	12.99
2.20	1.23	2.47	3.70	4.93	6.17	7.40	8.63	9.87	11.10	12.34
2.25	1.71	2.35	3.52	4.70	5.87	7.04	8.22	9.39	10.57	11.74
2.30	1.12	2.24	3.36	4.48	5.60	6.72	7.84	8.96	10.08	11.20
2.35	1.07	2.14	3.21	4.28	5.35	6.42	7.49	8.56	9.63	10.70
2.40	1.03	2.05	3.08	4.10	5.13	6.15	7.18	8.20	9.23	10.25
2.45	0.98	1.97	2.95	3.94	4.92	5.90	6.89	7.87	8.85	9.84
2.50	0.95	1.89	2.84	3.78	4.73	5.67	6.62	7.56	8.51	9.46
2.55	0.91	1.82	2.73	3.64	4.55	5.46	6.37	7.28	8.19	9.10
2.60	0.88	1.75	2.63	3.51	4.39	5.26	6.14	7.02	7.90	8.77
2.65	0.85	1.69	2.54	3.39	4.23	5.08	5.93	6.77	7.62	8.47
2.70	0.82	1.64	2.45	3.27	4.09	4.91	5.73	6.55	7.36	8.18
2.75	0.79	1.58	2.37	3.17	3.96	4.75	5.54	6.33	7.12	7.92
2.80	0.77	1.53	2.30	3.07	3.83	4.60	5.37	6.13	6.90	7.67
2.85	0.74	1.49	2.23	2.97	3.72	4.46	5.20	5.94	6.69	7.43
2.90	0.72	1.44	2.16	2.88	3.61	4.33	5.05	5.77	6.49	7.21
2.95	0.70	1.40	2.10	2.80	3.50	4.20	4.90	5.60	6.30	7.00
3.00	0.68	1.36	2.04	2.72	3.40	4.08	4.76	5.45	6.13	6.81
3.05	0.66	1.32	1.99	2.65	3.31	3.97	4.63	5.30	5.96	6.62
3.10	0.64	1.29	1.93	2.58	3.22	3.87	4.51	5.16	5.80	6.45
3.15	0.63	1.26	1.88	2.51	3.14	3.77	4.40	5.02	5.65	6.28
3.20	0.61	1.22	1.84	2.45	3.06	3.67	4.28	4.90	5.51	6.12
3.25	0.60	1.19	1.79	2.39	2.99	3.58	4.18	4.78	5.37	5.97
3.30	0.58	1.17	1.75	2.33	2.91	3.50	4.08	4.66	5.24	5.83



Elektronische Bauelemente

SSC2156

600mA CMOS

Positive Voltage Regulator

External Resistor Divider Table

R1(K Ohm)	1	2	3	4	5	6	7	8	9	10
VOUT	$R2(K\ Ohm)=(1.215*R1(K\ Ohm))/(V_{OUT}-1.215)$									
3.35	0.57	1.14	1.71	2.28	2.85	3.41	3.98	4.55	5.12	5.69
3.40	0.56	1.11	1.67	2.22	2.78	3.34	3.89	4.45	5.00	5.56
3.45	0.54	1.09	1.63	2.17	2.72	3.26	3.81	4.35	4.89	5.44
3.50	0.53	1.06	1.60	2.13	2.66	3.19	3.72	4.25	4.79	5.32
3.55	0.52	1.04	1.56	2.08	2.60	3.12	3.64	4.16	4.68	5.20
3.60	0.51	1.02	1.53	2.04	2.55	3.06	3.57	4.08	4.58	5.09
3.65	0.50	1.00	1.50	2.00	2.49	2.99	3.49	3.99	4.49	4.99
3.70	0.49	0.98	1.47	1.96	2.44	2.93	3.42	3.91	4.40	4.89
3.75	0.48	0.96	1.44	1.92	2.40	2.88	3.36	3.83	4.31	4.79
3.80	0.47	0.94	1.41	1.88	2.35	2.82	3.29	3.76	4.23	4.70
3.85	0.46	0.92	1.38	1.84	2.31	2.77	3.23	3.69	4.15	4.61
3.90	0.45	0.91	1.36	1.81	2.26	2.72	3.17	3.62	4.07	4.53
3.95	0.44	0.89	1.33	1.78	2.22	2.67	3.11	3.55	4.00	4.44
4.00	0.44	0.87	1.31	1.75	2.18	2.62	3.05	3.49	3.93	4.36
4.05	0.43	0.86	1.29	1.71	2.14	2.57	3.00	3.43	3.86	4.29
4.10	0.42	0.84	1.26	1.68	2.11	2.53	2.95	3.37	3.79	4.21
4.15	0.41	0.83	1.24	1.66	2.07	2.48	2.90	3.31	3.73	4.14
4.20	0.41	0.81	1.22	1.63	2.04	2.44	2.85	3.26	3.66	4.07
4.25	0.40	0.80	1.20	1.60	2.00	2.40	2.80	3.20	3.60	4.00
4.30	0.39	0.79	1.18	1.58	1.97	2.36	2.76	3.15	3.54	3.94
4.35	0.39	0.78	1.16	1.55	1.94	2.33	2.71	3.10	3.49	3.88
4.40	0.38	0.76	1.14	1.53	1.91	2.29	2.67	3.05	3.43	3.81
4.45	0.38	0.75	1.13	1.50	1.88	2.25	2.63	3.00	3.38	3.76
4.50	0.37	0.74	1.11	1.48	1.85	2.22	2.59	2.96	3.33	3.70
4.55	0.36	0.73	1.09	1.46	1.82	2.19	2.55	2.91	3.28	3.64
4.60	0.36	0.72	1.08	1.44	1.79	2.15	2.51	2.87	3.23	3.59
4.65	0.35	0.71	1.06	1.41	1.77	2.12	2.48	2.83	3.18	3.54
4.70	0.35	0.70	1.05	1.39	1.74	2.09	2.44	2.79	3.14	3.49
4.75	0.34	0.69	1.03	1.37	1.72	2.06	2.41	2.75	3.09	3.44
4.80	0.34	0.68	1.02	1.36	1.69	2.03	2.37	2.71	3.05	3.39
4.85	0.33	0.67	1.00	1.34	1.67	2.01	2.34	2.67	3.01	3.34
4.90	0.33	0.66	0.99	1.32	1.65	1.98	2.31	2.64	2.97	3.30
4.95	0.33	0.65	0.98	1.30	1.63	1.95	2.28	2.60	2.93	3.25
5.00	0.32	0.64	0.96	1.28	1.61	1.93	2.25	2.57	2.89	3.21