

## Non Magnetic SMQ MELF PIN Diode

### Features

- ◆ Non-Magnetic Package Suitable for MRI Applications
- ◆ Rectangular MELF SMQ Ceramic Package
- ◆ Hermetically Sealed
- ◆ Low  $R_s$  for Low Series Loss
- ◆ Long  $\tau_L$  for Lower Intermodulation Distortion
- ◆ Low  $C_j$  for High Series Isolation
- ◆ High Average Incident Power Handling
- ◆ RoHS Compliant

### Description

The MA4P7464F-1072T is a surface mountable PIN diode in a non-magnetic, **Metal Electrode Leadless Faced (MELF)** package. The device incorporates M/A-COM Technology Solutions time proven HIPAX technology to produce a low inductance ceramic package with no ribbons or whisker wires. Incorporated in the package is a hard glass passivated, CERMACHIP™ PIN chip that is full face bonded on both the cathode and anode to maximize surface area for the lowest electrical and thermal resistance. The package utilizes a non-magnetic plating process that provides for a package with extremely low permeability. The MA4P7464F-1072T has been comprehensively characterized both electrically and mechanically to ensure repeatable and predictable performance. The non-magnetic MA4P7464F-1072T is the electrical equivalent of its magnetic counterpart the MA4P7004F-1072T.

### Applications

This diode is well suited for use in low loss, low distortion, high power switching circuits and can be used in high magnetic field environments at HF through UHF frequencies. The low thermal resistance of this device provides excellent performance at high RF power incident levels, up to 100 watts CW. This device is designed to meet the most demanding electrical and mechanical MRI environments.

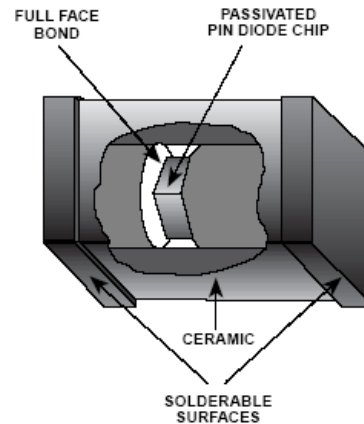

### Designed for Automated Assembly

These SMQ PIN diodes are designed for high volume tape and reel assembly. The rectangular package design provides for highly efficient automatic pick and place assembly techniques. The parallel flat surfaces are suitable for key jaw or vacuum pickup. All solderable surfaces are tin plated and compatible with reflow and vapor phase soldering methods.

### Absolute Maximum Ratings<sup>1</sup> @ 25°C

Parameter	Absolute Maximum
Operating Temperature	-65 °C to +125°C
Storage Temperature	-65 °C to +150°C
Diode Junction Temperature	+175 °C Continuous
Diode Mounting Temperature	+265°C for 10 seconds
RF C.W. Incident Power	+ 50 dBm C.W.
Forward D.C. Current	+ 250 mA
Reverse D.C. Voltage @ -10uA	I - 400 V I

1. Exceeding these limits may cause permanent damage.

## Non Magnetic SMQ MELF PIN Diode

### Electrical Specifications @ +25 °C

Parameter	Symbol	Condition	Unit Value
Forward Voltage (Maximum)	$V_F$	$I_F = +100 \text{ mA}$	$1.0 \text{ V}_{DC}$
Voltage Rating (Minimum)	$V_R$	$I_r = -10 \text{ uA}$	$I - 400 \text{ I V}_{DC}$
Total Capacitance (Maximum)	$C_T$	$-100 \text{ V @ } 100 \text{ MHz}$	$0.8 \text{ pF}$
Series Resistance (Maximum)	$R_S$	$+100 \text{ mA @ } 100 \text{ MHz}$	$0.5 \text{ Ohms}$
Parallel Resistance (Minimum)	$R_P$	$-10 \text{ V @ } 100 \text{ MHz}$	$75 \text{ K } \Omega$
Carrier Lifetime (Nominal)	$\tau_L$	$+6 \text{ mA} / -10 \text{ mA @}$ $(50\% - 90\% \text{ Voltage})$	$4.5 \text{ } \mu\text{s}$
I-Region Length (Nominal)	$\mu\text{m}$	-	$100 \text{ } \mu\text{m}$
C.W. Thermal Resistance (Maximum)	$\theta$	-	$20 \text{ } ^\circ\text{C/W}$
Power Dissipation in Free Air (Maximum)	$W$	$I_F = +100 \text{ mA}$	$2.5 \text{ W}$
Power Dissipation (Maximum)	$P_D$	$I_F = +100 \text{ mA}$	$7.5 \text{ W}$

### Environmental Capability

MELF devices are appropriate for use in industrial and military applications and can be screened to meet the environmental requirements of MIL-STD-750, MIL-STD-202 as well as other military standards. The table below lists some of the MIL-STD 750 tests the device is designed to meet.

Test	Method	Description
High Temperature Storage	1031	$+150^\circ\text{C}$ , for 340 Hours
Temperature Shock	1051	$-65^\circ\text{C}$ to $+150^\circ\text{C}$ , 20 Cycles
HTRB	1038	80% of rated $V_B$ , $+150^\circ\text{C}$ , for 96 Hours
Moisture Resistance	1021	No Initial Conditioning, 85% RH, $+85^\circ\text{C}$
Gross Leak	1071 Cond. E	Dye Penetrant Visual
Vibration Fatigue	2046	20,000G's, 60Hz, x, y, z axis
Solderability	2026	Test Temperature = $+245^\circ\text{C}$

## Non Magnetic SMQ MELF PIN Diode

### Typical Electrical Performance @ +25°C

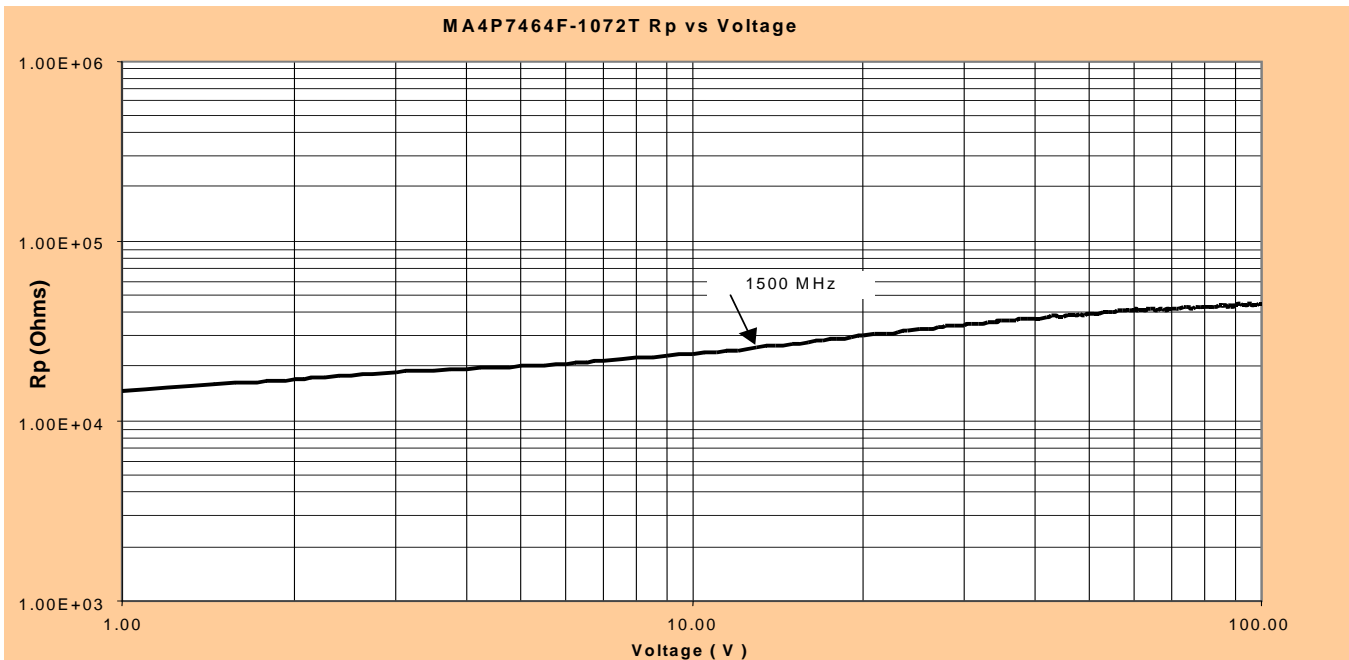
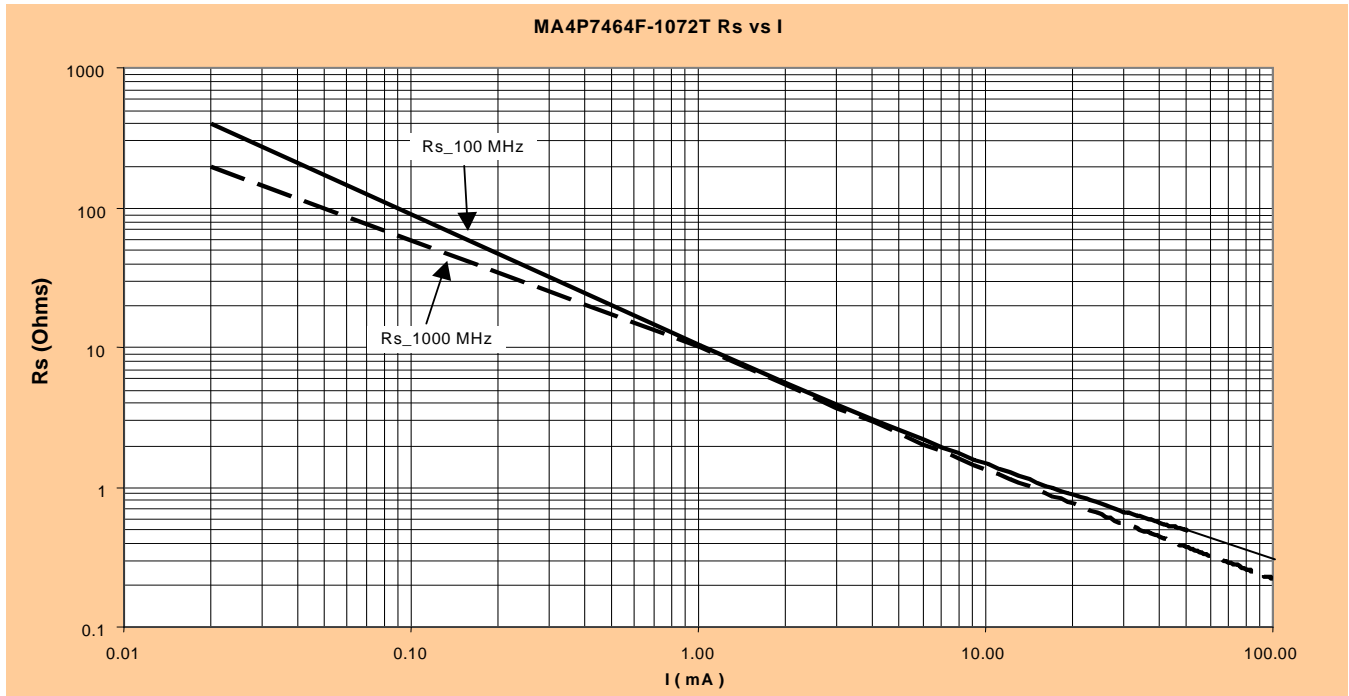

**ADVANCED:** Data Sheets contain information regarding a product M/A-COM is considering for development. Performance is based on target specifications, simulated results, and/or prototype measurements. Commitment to develop is not guaranteed.

**PRELIMINARY:** Data Sheets contain information regarding a product M/A-COM has under development. Performance is based on engineering tests. Specifications are typical. Mechanical outline has been fixed. Engineering samples and/or test data may be available. Commitment to produce in volume is not guaranteed.

- **North America** Tel: 800.366.2266 / Fax: 978.366.2266
- **Europe** Tel: 44.1908.574.200 / Fax: 44.1908.574.300
- **Asia/Pacific** Tel: 81.44.844.8296 / Fax: 81.44.844.8298

Visit [www.macom.com](http://www.macom.com) for additional data sheets and product information.

M/A-COM Inc. and its affiliates reserve the right to make changes to the product(s) or information contained herein without notice.

## Non Magnetic SMQ MELF PIN Diode

### Typical Electrical Performance @ +25°C

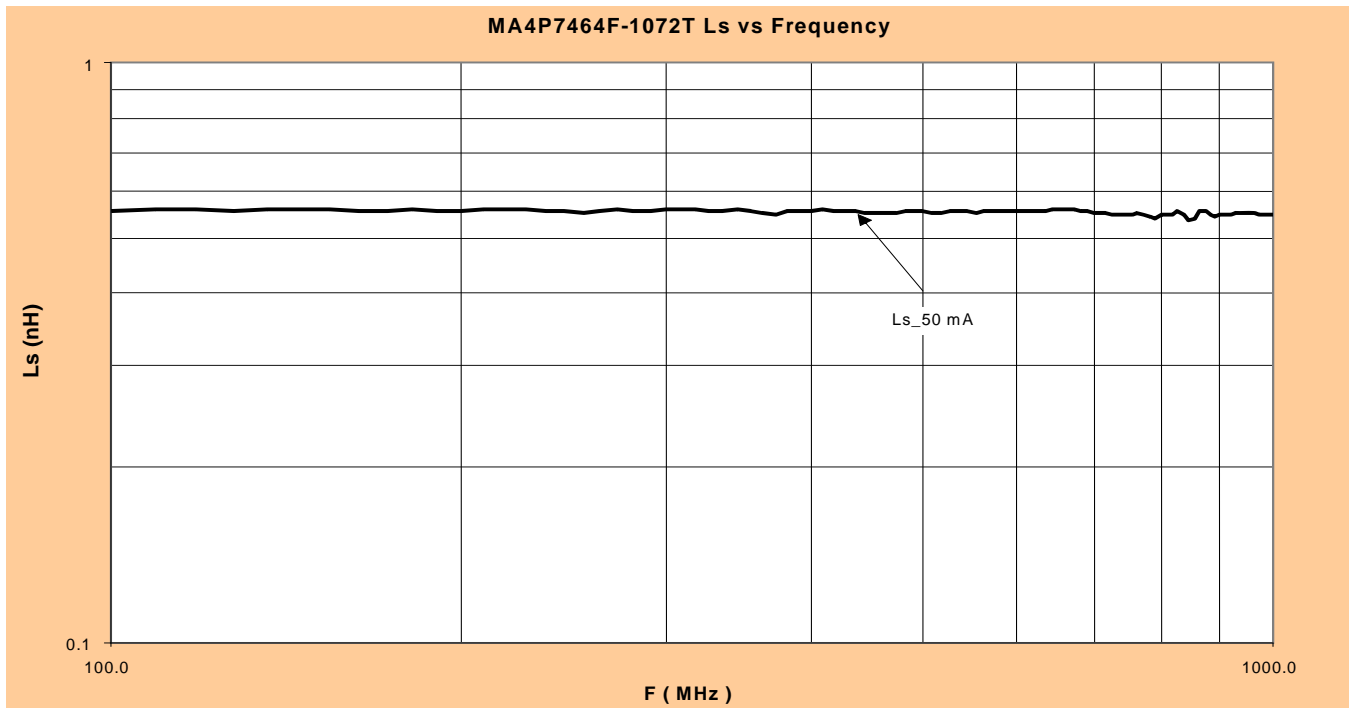
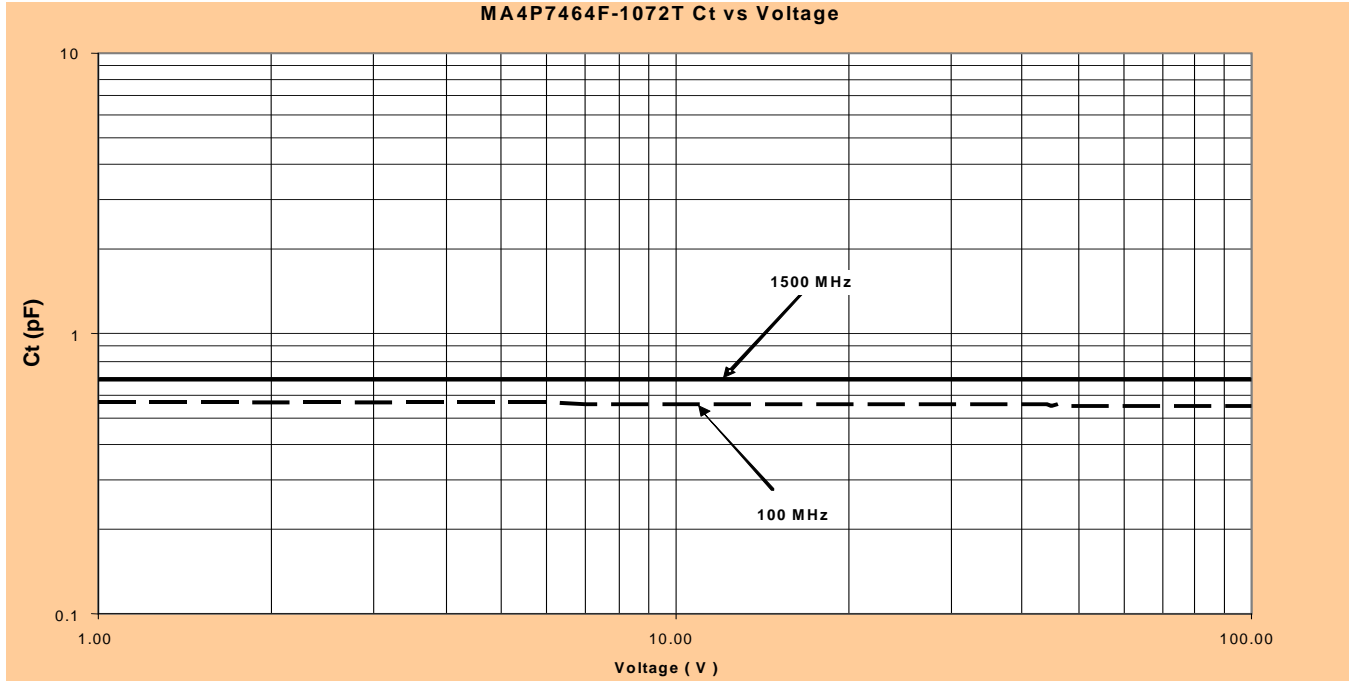

**ADVANCED:** Data Sheets contain information regarding a product M/A-COM is considering for development. Performance is based on target specifications, simulated results, and/or prototype measurements. Commitment to develop is not guaranteed.

**PRELIMINARY:** Data Sheets contain information regarding a product M/A-COM has under development. Performance is based on engineering tests. Specifications are typical. Mechanical outline has been fixed. Engineering samples and/or test data may be available. Commitment to produce in volume is not guaranteed.

- **North America** Tel: 800.366.2266 / Fax: 978.366.2266
- **Europe** Tel: 44.1908.574.200 / Fax: 44.1908.574.300
- **Asia/Pacific** Tel: 81.44.844.8296 / Fax: 81.44.844.8298

Visit [www.macom.com](http://www.macom.com) for additional data sheets and product information.

M/A-COM Inc. and its affiliates reserve the right to make changes to the product(s) or information contained herein without notice.

## Non Magnetic SMQ MELF PIN Diode

### Typical Non-Magnetic Performance

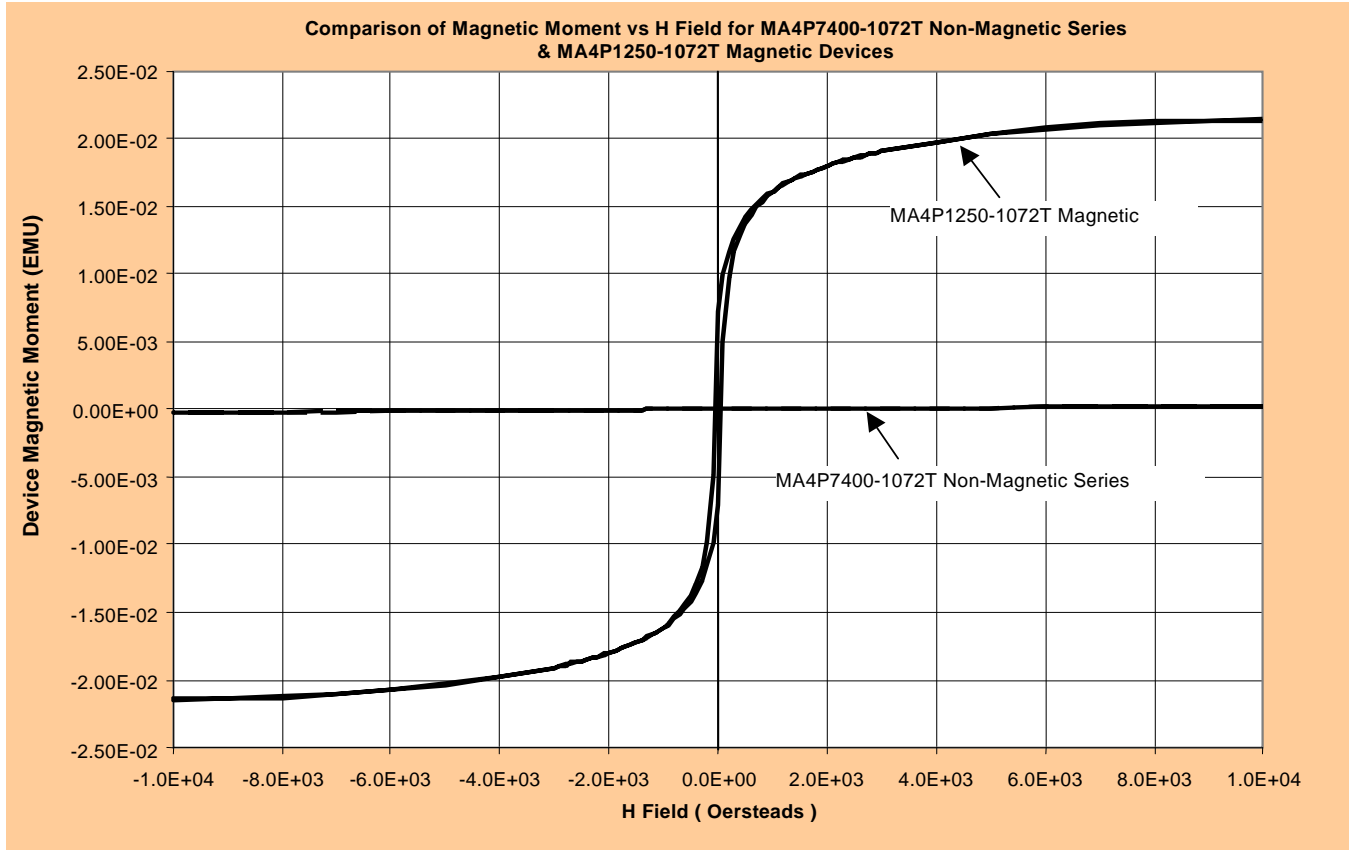

### Typical Magnetic Properties of Non-Magnetic MA4P7464F-1072T Device vs. Conventional MA4P1250-1072T Magnetic Device

Magnetic Property	MA4P7464F-1072T Value	MA4P1250-1072T Value
Saturation Moment (EMU) @ H = H <sub>MAX</sub> Oersteads	2.3 x E-4	2.1 x E-2
Remanance Moment (EMU) @ H = 0 Oersteads	4.2 x E-8	7.1 x E-3
Coercivity (Oersteads) @ EMU = 0 Moment	1	59.2

## Non Magnetic SMQ MELF PIN Diode

### Mechanical Outline

#### 1072 MELF Surface Mount Package

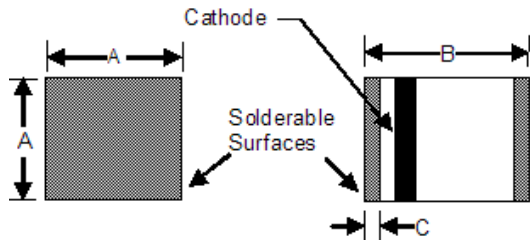

Dimension	Inches	Milimeters
A	0.093	2.36
B	0.050	1.27
C	0.060	1.52

#### Circuit Pad Layout for MELF Diodes

Dimension	Package Style 1072	
	inches	mm
A	0.093	2.36
B	0.050	1.27
C	0.060	1.52

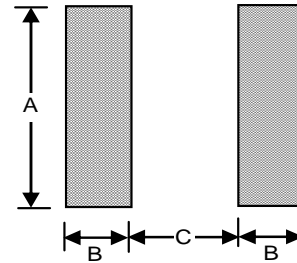

### MELF Assembly Recommendations

- ◆ Devices may be soldered using standard 60Sn/40Pb or RoHS compliant solders. All solderable surfaces of MELF devices are tin plated 50  $\mu\text{M}$  thick to ensure an optimum connection.
- ◆ For recommended Sn/Pb and RoHS soldering profiles See Application Note [M538](#) on the M/A-COM Tech website.

### Ordering Information

Part Number	Package	Quantity per Reel
MA4P7464F-1072T	Tape and Reel	1500pcs