

Features

- High Linear Gain: 22 dB Typical
- High Saturated Output Power: +31.5 dBm Typical
- High Power Added Efficiency: 22% Typical
- 50 Ω Input/Output Broadband Matched
- Integrated Output Power Detector
- Lead-Free Ceramic Bolt Down Package
- RoHS* Compliant and 260°C Reflow Compatible

Description

The AM42-0002 is a three-stage MMIC linear power amplifier in a lead-free, ceramic bolt down style hermetic package. The AM42-0002 employs a fully matched chip with internally decoupled gate and drain bias networks and an output power detector. The AM42-0002 is designed to be operated from a constant voltage drain supply.

The AM42-0002 is designed for use as an output stage or a driver, in applications for VSAT systems. This design is fully monolithic and requires a minimum of external components.

The AM42-0002 is fabricated using a mature 0.5 micron GaAs MESFET process. The process features full passivation for increased performance and reliability. This product is 100% RF tested to ensure compliance to performance specifications.

Ordering Information

Part Number	Package
AM42-0002	Ceramic Bolt Down

Functional Schematic

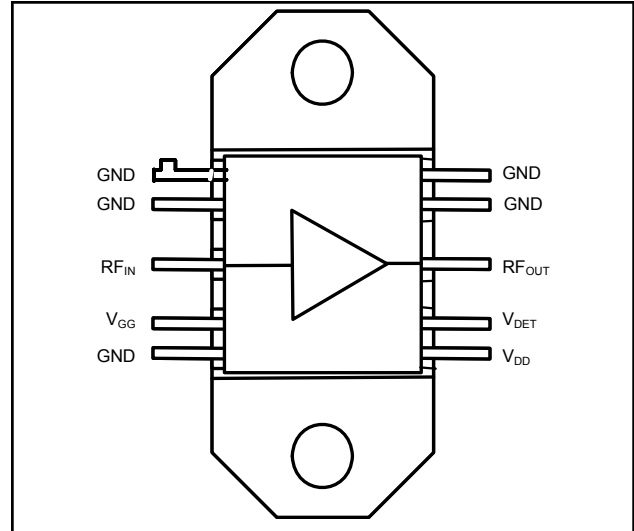

Pin Configuration

Pin No.	Pin Name	Description
1	GND	DC and RF Ground
2	GND	DC and RF Ground
3	RF _{IN}	RF Input
4	V _{GG}	Gate Supply
5	GND	DC and RF Ground
6	V _{DD}	Voltage Drain Supply
7	V _{DET}	Output Power Detector
8	RF _{OUT}	RF Output
9	GND	DC and RF Ground
10	GND	DC and RF Ground

* Restrictions on Hazardous Substances, European Union Directive 2002/95/EC.

Electrical Specifications: $T_A = +25^\circ\text{C}$, $V_{DD} = +9\text{ V}$, $V_{GG} = -5.0\text{ V}$, $Z_0 = 50\Omega$

Parameter	Test Conditions	Units	Min.	Typ.	Max.
Linear Gain	$P_{IN} \leq 0\text{ dBm}$	dB	19	22	—
Input VSWR	$P_{IN} \leq 0\text{ dBm}$	Ratio	—	2.5:1	2.7:1
Output VSWR	$P_{IN} \leq 0\text{ dBm}$	Ratio	—	2.7:1	—
Saturated Output Power	$P_{IN} = +14\text{ dBm}$	dBm	30.5	31.5	—
Output Power at P1dB	—	dBm	31	29.5	—
Output IP3	Two +24 dB, output tones @ 1 MHz spacing	dBm	—	39	—
Power Added Efficiency	$P_{IN} = +14\text{ dBm}$	%	—	22	—
Bias Current	$P_{IN} = +14\text{ dBm}$	mA	—	800	1400
Thermal Resistance	25°C Heat Sink	$^\circ\text{C}/\text{W}$	—	9.5	—
Detector Output Voltage	$R_L = 10\text{ K}\Omega$, $P_{OUT} = +31\text{dBm}$	V	—	+3.5	—

Absolute Maximum Ratings ^{1,2,3}

Parameter	Absolute Maximum
V_{DD}	12 Volts
V_{GG}	-10 Volts
Power Dissipation	13.2 W
RF Input Power	+23 dBm
Channel Temperature	150°C
Storage Temperature	-65°C to $+150^\circ\text{C}$

1. Exceeding any one or combination of these limits may cause permanent damage to this device.
2. M/A-COM Technology does not recommend sustained operation near these survivability limits.
3. Case Temperature (T_C) = $+25^\circ\text{C}$.

Typical Bias Configuration ^{4,5,6,7,8,9}

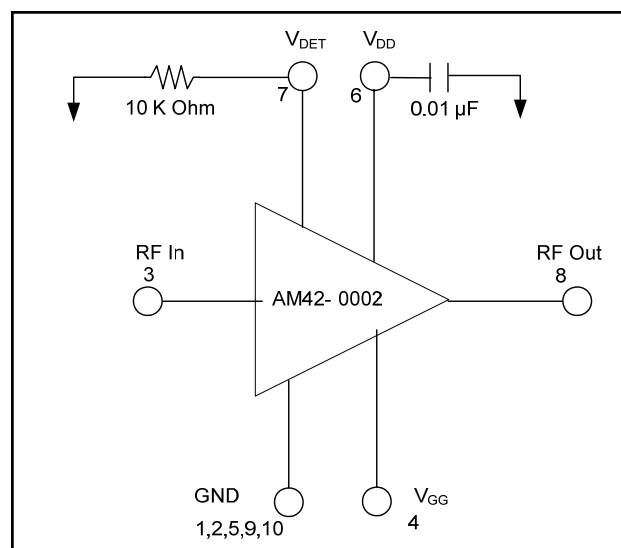

4. Nominal bias is obtained by first connecting -5 volts to pin 4 (V_{GG}), followed by connection $+9\text{ volts}$ to pin 6 (V_{DD}). Note sequence.
5. RF ground and thermal interface is the flange (case bottom). Adequate heat sinking is required.
6. No DC bias voltage appears at the RF ports.
7. The DC resistance at the input port is an open circuit and at the output port is a short circuit.
8. For optimum IP3 performance, the V_{DD} bypass capacitors should be placed within 0.5 inches of pin 6.
9. Resistor and capacitors surrounding the amplifier are suggestions and not included as part of the AM42-0002.

Typical Performance Curves @ +25°C

Linear Gain vs. Frequency

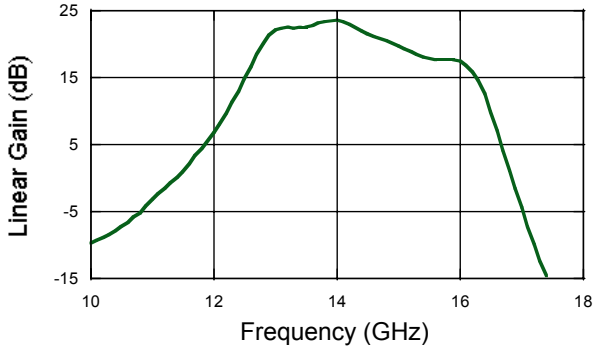

Input and Output Return Loss vs. Frequency

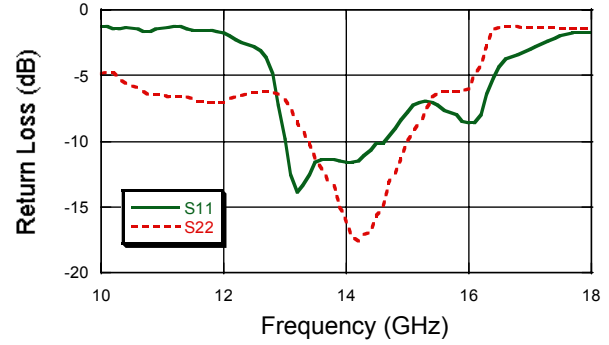

Output Power & PAE vs. Input Power @ 14.25 GHz

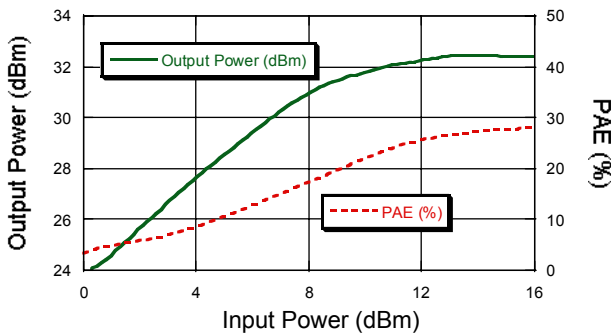

Detector Voltage vs. Output Power @ 14.25 GHz

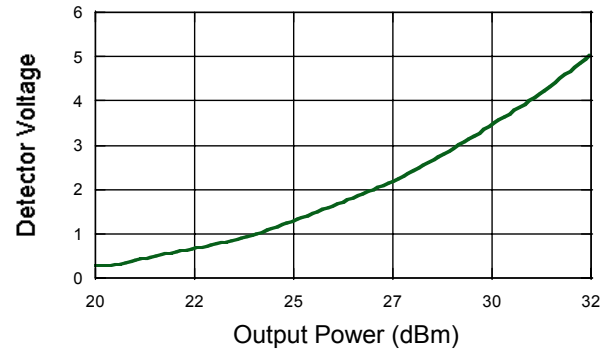

Output Power vs. Frequency @ $P_{IN} = +14$ dBm

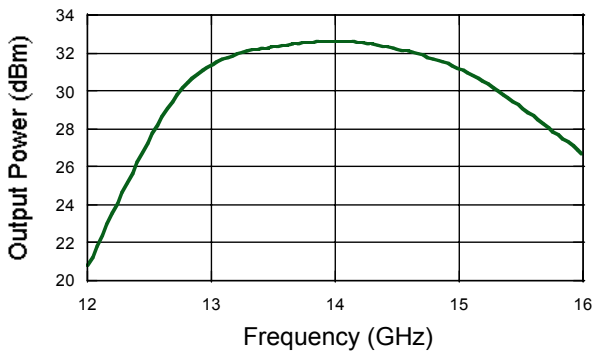

PAE vs. Frequency @ $P_{IN} = +14$ dBm

