

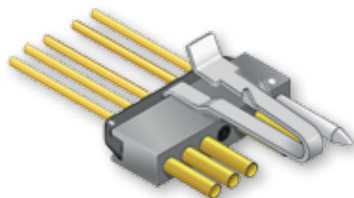

Series 171 MicroStrips Single Row Strips with Solid Wire 171-002



171-002-7S-5C4-1.000-P1CL

MicroStrips with Solid Wire

These .050" pitch single row microstrips are factory-crimped to gold-plated single strand copper wire. Available with 1 to 30 contacts. Can be used for PCB header. Solder-dipped versions have 63/37 tin-lead solder. Optional latching mechanism provides secure connection. Guide pins provide circuit polarization. Contacts are twistpin type and are gold-plated. Housing is molded LCP thermoplastic. Suitable for high-reliability applications where long-term resistance to fretting corrosion is a necessity. 3 A., 600 Vac, -55C to +150C.

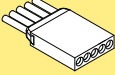
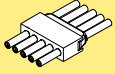
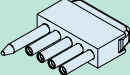
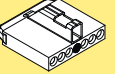
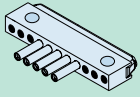
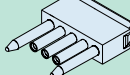
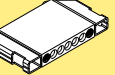
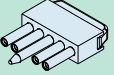
How To Order Microstrips With Solid Wire										
Series	Number of Cavities	Contact Type	Wire Gage	Wire Type	Wire Finish	Wire Length (Inches)	Optional Guide Pin	Optional Latch	Optional Mounting Holes	
171-002 Single Row MicroStrip, .050" Contact Spacing, Solid Wire	-1 TO -30 Total Number of Cavities including guide pins, latches and mounting holes. The number of cavities equals the number of electrical circuits plus 1 cavity for each guide pin and latch, plus 6 cavities for the mounting hole option.	P Pin Contacts 	-4 #24 AWG	C Single Strand Copper	3 Solder Dipped in 63/37 Tin-Lead	.125 .250 .500 1.000 1.500 2.000	Omit For No Guide Pin	Omit For No Latch	Omit For No Mounting Holes	
		S Socket Contacts 	-5 #25 AWG	A-A-59551 Type S	4 Gold-plated	Wire Length In Inches	-P1 Guide Pin in Cav. #1 	CL Center Latch 	MH Mounting Holes 	
			-6 #26 AWG				-PB Guide Pin at Both Ends 	BL Latch at Both Ends 	The three cavities on each end are filled with epoxy. Two .062" (1.57mm) holes are cross-drilled to allow for attachment to a mounting surface.	
						-P(X) Replace (X) with guide pin location. P3 shown below: 				
Sample Part Number										
171-002	-7	S	-5	C	4	-1.000	-P1	CL		



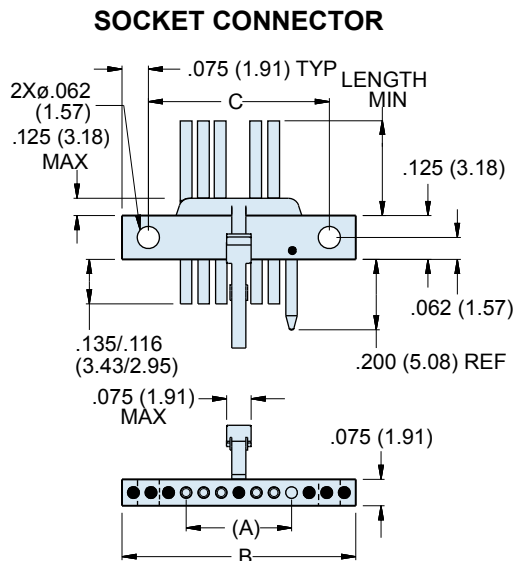
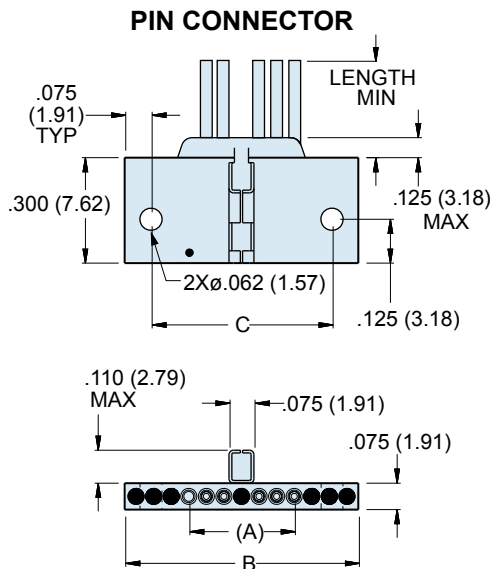

Dimensions

# of Cavities	(A)		B Max.		C		# of Cavities	(A)		B Max.		C	
	In.	mm.	In.	mm.	In.	mm.		In.	mm.	In.	mm.	In.	mm.
1	-	-	.085	2.16	N/A	N/A	16	.750	19.05	.835	21.21	.650	16.51
2	.050	1.27	.135	3.43	N/A	N/A	17	.800	20.32	.885	22.48	.700	17.78
3	.100	2.54	.185	4.70	N/A	N/A	18	.850	21.59	.935	23.75	.750	19.05
4	.150	3.81	.235	5.97	N/A	N/A	19	.900	22.86	.985	25.02	.800	20.32
5	.200	5.08	.285	7.24	N/A	N/A	20	.950	24.13	1.035	26.29	.850	21.59
6	.250	6.35	.335	8.51	N/A	N/A	21	1.000	25.40	1.085	27.56	.900	22.86
7	.300	7.62	.385	9.78	.200	5.08	22	1.050	26.67	1.135	28.83	.950	24.13
8	.350	8.89	.435	11.05	.250	6.35	23	1.100	27.94	1.185	30.10	1.000	25.4
9	.400	10.16	.485	12.32	.300	7.62	24	1.150	29.21	1.235	31.37	1.050	26.67
10	.450	11.43	.535	13.59	.350	8.89	25	1.200	30.48	1.285	32.64	1.100	27.94
11	.500	12.70	.585	14.86	.400	10.16	26	1.250	31.75	1.335	33.91	1.150	29.21
12	.550	13.97	.635	16.13	.450	11.43	27	1.300	33.02	1.385	35.18	1.200	30.48
13	.600	15.24	.685	17.40	.500	12.7	28	1.350	34.29	1.435	36.45	1.250	31.75
14	.650	16.51	.735	18.67	.550	13.97	29	1.400	35.56	1.485	37.72	1.300	33.02
15	.700	17.78	.785	19.94	.600	15.24	30	1.450	36.83	1.535	38.99	1.350	34.29

Center Latch Locations

Even Number of Cavities

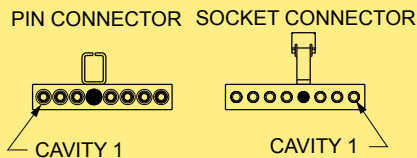

Latch placed on next lower cavity prior to centerline.
 Latch position = (# of Cavities) ÷ 2.

Odd Number of Cavities

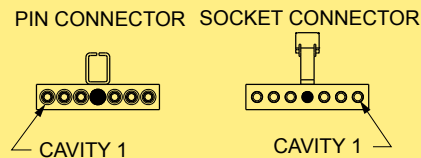

Latch placed in cavity on centerline.
 Latch Position = (# of Cavities+1) ÷ 2.