

890-006 and -007  
**Series 89 Nanominiature Connectors**  
**Single Row Vertical Mount Printed Circuit Board**

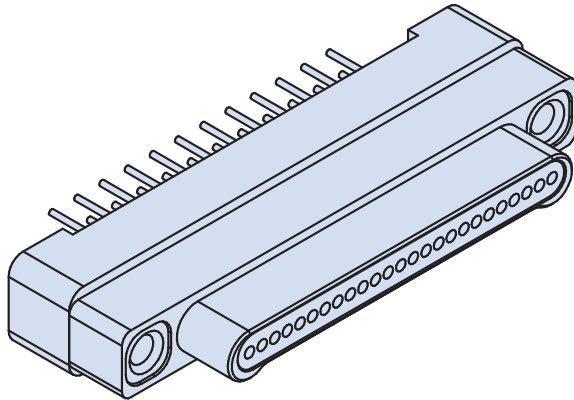

**Vertical Mount PCB Nano Connectors** feature gold alloy TwistPin contacts. These nanominiature connectors offer premium performance and reliability for demanding applications. Available with #0-80 female threads, or with jackscrews for use with flexible circuits.

**Pre-Tinned PC Tails** are coated with Sn63Pb37 tin-lead for excellent solderability.

**Choose Aluminum, Titanium or Stainless Steel Shells** in seven layouts from 9 to 51 contacts. Complies to the requirements of MIL-DTL-32139. These connectors are intermateable with any corresponding Glenair Series 890 single row metal shell nanominiature connector.

**HOW TO ORDER VERTICAL MOUNT PCB CONNECTORS**

Series	Insert Arrangement/ Contact Type	Shell Material and Finish	Termination Type	PC Tail Length	Hardware
<b>890-006</b> Plug, Pin Contacts, Single Row, Vertical PCB Nanominiature	Plugs (890-006) <b>9P</b> <b>15P</b> <b>21P</b> <b>25P</b> <b>31P</b> <b>37P</b> <b>51P</b>	<b>A1</b> Aluminum Shell, Cadmium Plating	<b>BST</b> "Board Straight Thru- Hole"	<b>1</b> .110 Inch (2.79 mm)	<b>J</b> Jackscrew, #0-80
		<b>A2</b> Aluminum Shell, Electroless Nickel Plating		<b>2</b> .172 Inch (4.37 mm)	<b>T</b> #0-80 Female Thread
<b>890-007</b> Receptacle, Socket Contacts, Single Row, Vertical PCB Nanominiature	Receptacles (890-007) <b>9S</b> <b>15S</b> <b>21S</b> <b>25S</b> <b>31S</b> <b>37S</b> <b>51S</b>	<b>T</b> Titanium Shell, Unplated			
		<b>S</b> Stainless Steel Shell, Passivated			
<b>Sample Part Number</b>					
<b>890-007</b>	<b>- 31S</b>	<b>T</b>	<b>- BST</b>	<b>1</b>	<b>T</b>

**MATERIALS AND FINISHES**

Connector Shell	See Ordering Information
Insulator	Liquid Crystal Polymer (LCP), 30% Glass-Filled
Contacts	Gold Alloy, Unplated
Hardware	300 Series Stainless Steel
PC Tails	#30 (.010 Dia.) Copper Wire, Solder Dipped
PCB Trays	Liquid Crystal Polymer (LCP) or Epoxy
Encapsulant	Epoxy

**SPECIFICATIONS**

Durability	200 Cycles Minimum
Current Rating	1 AMP Maximum
Voltage Rating (DWV)	300 VAC RMS Sea Level
Insulation Resistance	5000 Megohms Minimum
Operating Temperature	-55° C. to +125° C.
Contact Resistance	71 mV. @1 AMP #30 AWG Wire
Thermal Vacuum Outgassing	1.0% Max TML, 0.1% Max. VCM

#### SINGLE ROW VERTICAL NANO PCB DIMENSIONS

##### Plug (Pin) Connectors

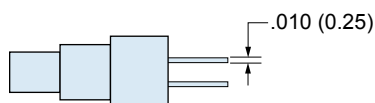
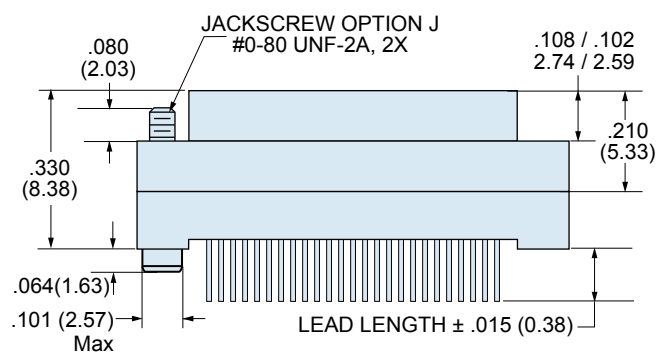
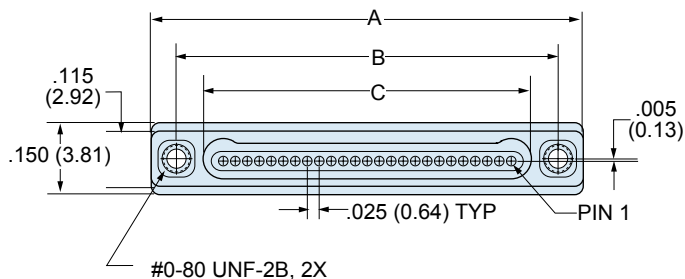

##### Receptacle (Socket) Connectors

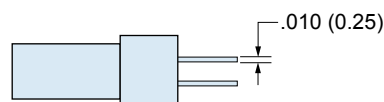
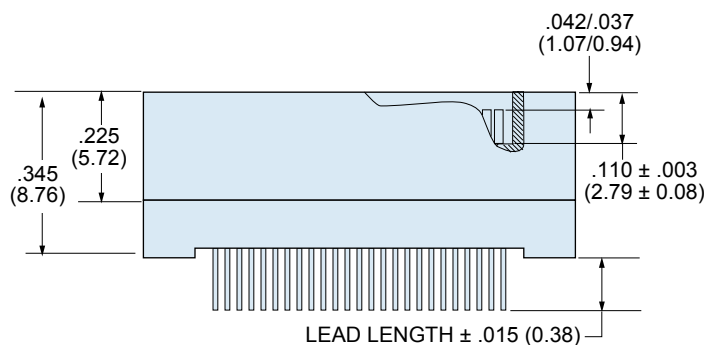
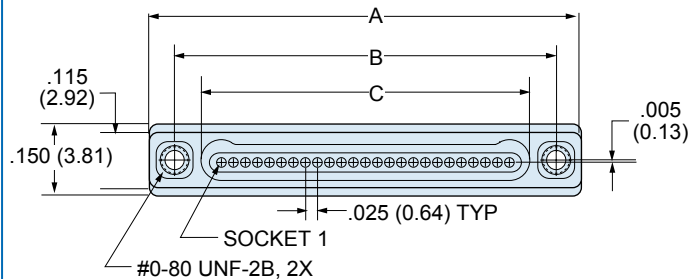

Layout	A		B BSC.		C BSC.	
	In. ± .005	mm. ± 0.13	In.	mm.	In.	mm.
9P	.500	12.70	.395	10.03	.284	7.21
9S	.500	12.70	.395	10.03	.285	7.24
15P	.650	16.51	.545	13.84	.434	11.02
15S	.650	16.51	.545	13.84	.435	11.05
21P	.800	20.32	.695	17.65	.584	14.83
21S	.800	20.32	.695	17.65	.585	14.86
25P	.900	22.86	.795	20.19	.684	17.37
25S	.900	22.86	.795	20.19	.685	17.40
31P	1.050	26.67	.945	24.00	.834	21.18
31S	1.050	26.67	.945	24.00	.835	21.21
37P	1.200	30.48	1.095	27.81	.984	24.99
37S	1.200	30.48	1.095	27.81	.985	24.02
51P	1.550	39.37	1.445	36.70	1.334	33.88
51S	1.550	39.37	1.445	36.70	1.335	33.91

# 890-006 and -007

## Series 89 Nanominiature Connectors

### Single Row Vertical Mount Printed Circuit Board



Single Row Connectors

Patterns shown are for connector mounting side of PC Board.

#### VERTICAL PCB PLUG (PIN) CONNECTOR LAYOUT 890-006

#### 9 Contacts

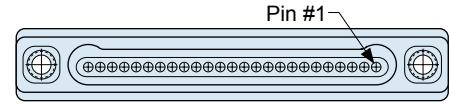
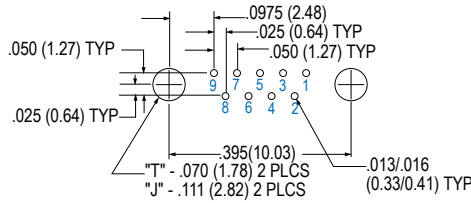

Connector Mating Face

#### 15 Contacts

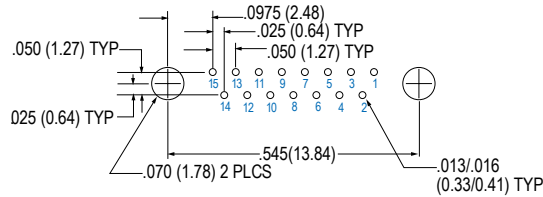

#### 21 Contacts

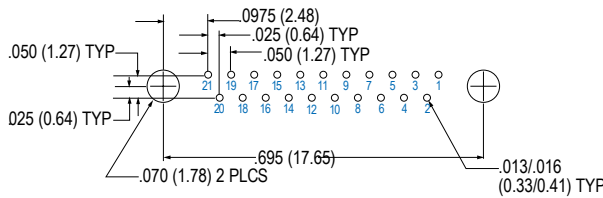

#### 25 Contacts

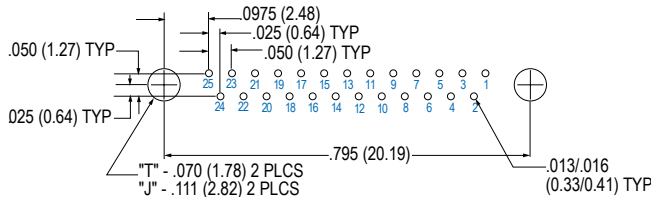

#### 31 Contacts

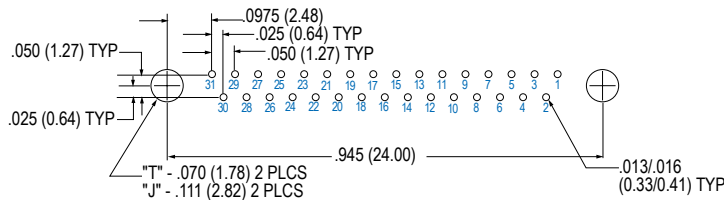

#### 37 Contacts

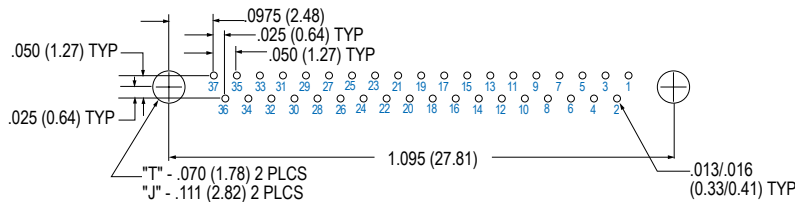

#### 51 Contacts

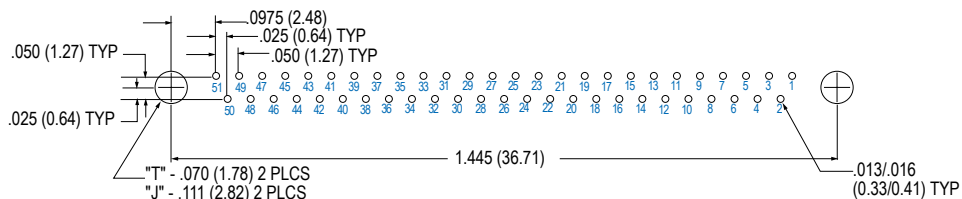

Patterns shown are for connector mounting side of PC Board.

## VERTICAL PCB RECEPTACLE (SOCKET) CONNECTOR LAYOUT 890-007

### 9 Contacts

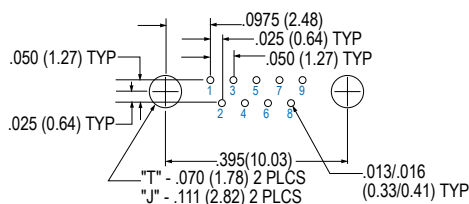

Socket #1

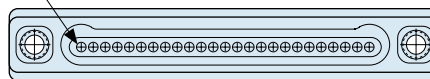

Connector Mating Face

### 15 Contacts

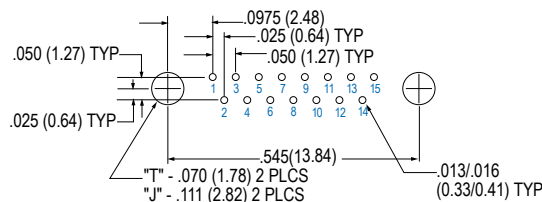

### 21 Contacts

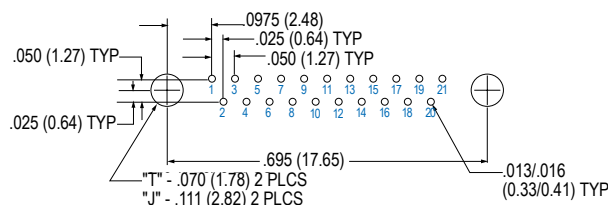

### 25 Contacts

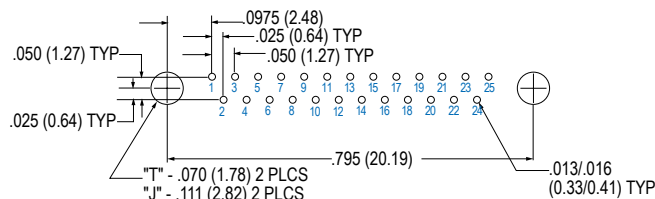

### 31 Contacts

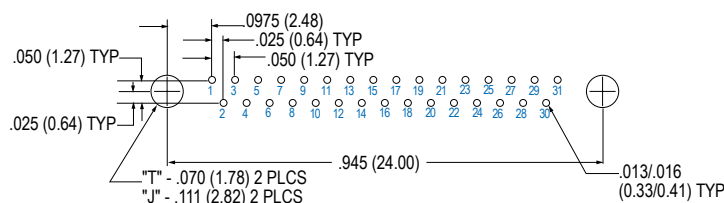

### 37 Contacts

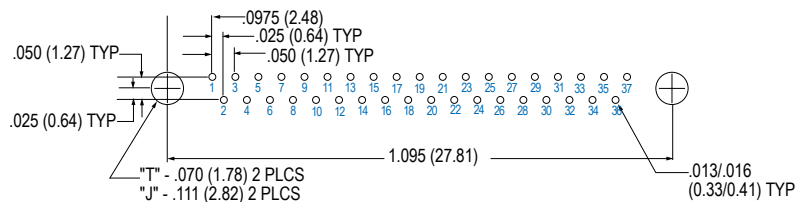

### 51 Contacts

