

**CoolMOS<sup>®</sup> Power Transistor**
**Features**

- New revolutionary high voltage technology
- Extreme dv/dt rated
- High peak current capability
- Qualified according to JEDEC<sup>1)</sup> for target applications
- Pb-free lead plating; RoHS compliant
- Ultra low gate charge
- Ultra low effective capacitances

**CoolMOS<sup>™</sup> 800V designed for:**

- Industrial application with high DC bulk voltage
- Switching Application ( i.e. active clamp forward )

**Product Summary**

|  |      |          |
|--|------|----------|
| $V_{DS}$                                   | 800  | V        |
| $R_{DS(on)max}$ @ $T_j = 25^\circ\text{C}$ | 0.29 | $\Omega$ |
| $Q_{g,typ}$                                | 88   | nC       |

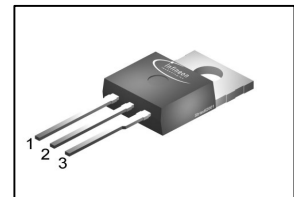
**PG-TO220-3**

| Type       | Package    | Marking |
|------------|------------|---------|
| SPP17N80C3 | PG-TO220-3 | 17N80C3 |

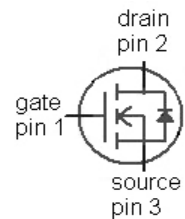
**Maximum ratings, at  $T_j=25^\circ\text{C}$ , unless otherwise specified**

| Parameter   | Symbol         | Conditions                             | Value       | Unit             |
|---|----------------|--|-------------|------------------|
| Continuous drain current                                | $I_D$          | $T_C=25^\circ\text{C}$                 | 17          | A                |
|   |                | $T_C=100^\circ\text{C}$                | 11          |                  |
| Pulsed drain current <sup>2)</sup>                      | $I_{D,pulse}$  | $T_C=25^\circ\text{C}$                 | 51          |                  |
| Avalanche energy, single pulse                          | $E_{AS}$       | $I_D=3.4\text{ A}, V_{DD}=50\text{ V}$ | 670         | mJ               |
| Avalanche energy, repetitive $t_{AR}$ <sup>2),3)</sup>  | $E_{AR}$       | $I_D=17\text{ A}, V_{DD}=50\text{ V}$  | 0.5         |                  |
| Avalanche current, repetitive $t_{AR}$ <sup>2),3)</sup> | $I_{AR}$       |  | 17          | A                |
| MOSFET dv/dt ruggedness                                 | dv/dt          | $V_{DS}=0\dots640\text{ V}$            | 50          | V/ns             |
| Gate source voltage                                     | $V_{GS}$       | static                                 | $\pm 20$    | V                |
|   |                | AC ( $f>1\text{ Hz}$ )                 | $\pm 30$    |                  |
| Power dissipation                                       | $P_{tot}$      | $T_C=25^\circ\text{C}$                 | 227         | W                |
| Operating and storage temperature                       | $T_j, T_{stg}$ |  | -55 ... 150 | $^\circ\text{C}$ |
| Mounting torque   |                | M3 and M3.5 screws                     | 60          | Ncm              |

Maximum ratings, at  $T_j=25\text{ °C}$ , unless otherwise specified

| Parameter                           | Symbol        | Conditions         | Value | Unit |
|-------------------------------------|---------------|--------------------|-------|------|
| Continuous diode forward current    | $I_S$         | $T_C=25\text{ °C}$ | 17    | A    |
| Diode pulse current <sup>2)</sup>   | $I_{S,pulse}$ |                    | 51    |      |
| Reverse diode $dv/dt$ <sup>4)</sup> | $dv/dt$       |                    | 4     | V/ns |

| Parameter | Symbol | Conditions | Values |      |      | Unit |
|-----------|--------|------------|--------|------|------|------|
|           |        |            | min.   | typ. | max. |      |

### Thermal characteristics

|   |            |                                      |   |   |      |     |
|---|------------|--------------------------------------|---|---|------|-----|
| Thermal resistance, junction - case                         | $R_{thJC}$ |                                      | - | - | 0.55 | K/W |
| Thermal resistance, junction - ambient                      | $R_{thJA}$ | leaded                               | - | - | 62   |     |
| Soldering temperature, wave soldering only allowed at leads | $T_{sold}$ | 1.6 mm (0.063 in.) from case for 10s | - | - | 260  | °C  |

Electrical characteristics, at  $T_j=25\text{ °C}$ , unless otherwise specified

### Static characteristics

|                                  |               |   |     |      |      |               |
|----------------------------------|---------------|---|-----|------|------|---------------|
| Drain-source breakdown voltage   | $V_{(BR)DSS}$ | $V_{GS}=0\text{ V}$ , $I_D=250\text{ }\mu\text{A}$                | 800 | -    | -    | V             |
| Avalanche breakdown voltage      | $V_{(BR)DS}$  | $V_{GS}=0\text{ V}$ , $I_D=17\text{ A}$                           | -   | 870  | -    |               |
| Gate threshold voltage           | $V_{GS(th)}$  | $V_{DS}=V_{GS}$ , $I_D=1.0\text{ mA}$                             | 2.1 | 3    | 3.9  |               |
| Zero gate voltage drain current  | $I_{DSS}$     | $V_{DS}=800\text{ V}$ , $V_{GS}=0\text{ V}$ , $T_j=25\text{ °C}$  | -   | -    | 25   | $\mu\text{A}$ |
|                                  |               | $V_{DS}=800\text{ V}$ , $V_{GS}=0\text{ V}$ , $T_j=150\text{ °C}$ | -   | 150  | -    |               |
| Gate-source leakage current      | $I_{GSS}$     | $V_{GS}=20\text{ V}$ , $V_{DS}=0\text{ V}$                        | -   | -    | 100  | nA            |
| Drain-source on-state resistance | $R_{DS(on)}$  | $V_{GS}=10\text{ V}$ , $I_D=11\text{ A}$ , $T_j=25\text{ °C}$     | -   | 0.25 | 0.29 | $\Omega$      |
|                                  |               | $V_{GS}=10\text{ V}$ , $I_D=11\text{ A}$ , $T_j=150\text{ °C}$    | -   | 0.67 | -    |               |
| Gate resistance                  | $R_G$         | $f=1\text{ MHz}$ , open drain                                     | -   | 0.85 | -    | $\Omega$      |

| Parameter | Symbol | Conditions | Values |      |      | Unit |
|-----------|--------|------------|--------|------|------|------|
|           |        |            | min.   | typ. | max. |      |

**Dynamic characteristics**

|  |              |   |   |      |   |    |
|--|--------------|---|---|------|---|----|
| Input capacitance  | $C_{iss}$    | $V_{GS}=0\text{ V}, V_{DS}=100\text{ V},$   | - | 2300 | - | pF |
| Output capacitance   | $C_{oss}$    | $f=1\text{ MHz}$  | - | 94   | - |    |
| Effective output capacitance, energy related <sup>5)</sup> | $C_{o(er)}$  | $V_{GS}=0\text{ V}, V_{DS}=0\text{ V}$<br>to 480 V  | - | 72   | - |    |
| Effective output capacitance, time related <sup>6)</sup>   | $C_{o(tr)}$  |   | - | 210  | - |    |
| Turn-on delay time   | $t_{d(on)}$  | $V_{DD}=400\text{ V},$<br>$V_{GS}=10\text{ V}, I_D=17\text{ A},$<br>$R_G=4.7\ \Omega, T_j=25\text{ }^\circ\text{C}$ | - | 25   | - | ns |
| Rise time  | $t_r$        |   | - | 15   | - |    |
| Turn-off delay time  | $t_{d(off)}$ |   | - | 72   | - |    |
| Fall time  | $t_f$        |   | - | 12   | - |    |

**Gate Charge Characteristics**

|                       |               |   |   |     |     |    |
|-----------------------|---------------|---|---|-----|-----|----|
| Gate to source charge | $Q_{gs}$      | $V_{DD}=640\text{ V}, I_D=17\text{ A},$<br>$V_{GS}=0\text{ to }10\text{ V}$ | - | 12  | -   | nC |
| Gate to drain charge  | $Q_{gd}$      |   | - | 45  | -   |    |
| Gate charge total     | $Q_g$         |   | - | 88  | 117 |    |
| Gate plateau voltage  | $V_{plateau}$ |   | - | 5.5 | -   | V  |

**Reverse Diode**

|                               |           |   |   |     |     |               |
|-------------------------------|-----------|---|---|-----|-----|---------------|
| Diode forward voltage         | $V_{SD}$  | $V_{GS}=0\text{ V}, I_F=I_S=17\text{ A},$<br>$T_j=25\text{ }^\circ\text{C}$         | - | 1   | 1.2 | V             |
| Reverse recovery time         | $t_{rr}$  | $V_R=400\text{ V},$<br>$I_F=I_S=17\text{ A},$<br>$di_F/dt=100\text{ A}/\mu\text{s}$ | - | 550 | -   | ns            |
| Reverse recovery charge       | $Q_{rr}$  |   | - | 15  | -   | $\mu\text{C}$ |
| Peak reverse recovery current | $I_{rrm}$ |   | - | 51  | -   | A             |

<sup>1)</sup> J-STD20 and JESD22

<sup>2)</sup> Pulse width  $t_p$  limited by  $T_{j,max}$

<sup>3)</sup> Repetitive avalanche causes additional power losses that can be calculated as  $P_{AV}=E_{AR} \cdot f$ .

<sup>4)</sup>  $I_{SD}=I_D, di/dt=200\text{ A}/\mu\text{s}, V_{DClink} = 400\text{ V}, V_{peak}<V_{(BR)DSS}, T_j<T_{j,max}$ , identical low side and high side switch

<sup>5)</sup>  $C_{o(er)}$  is a fixed capacitance that gives the same stored energy as  $C_{oss}$  while  $V_{DS}$  is rising from 0 to 80%  $V_{DSS}$ .

<sup>6)</sup>  $C_{o(tr)}$  is a fixed capacitance that gives the same charging time as  $C_{oss}$  while  $V_{DS}$  is rising from 0 to 80%  $V_{DSS}$ .

**1 Power dissipation**

$P_{tot}=f(T_C)$

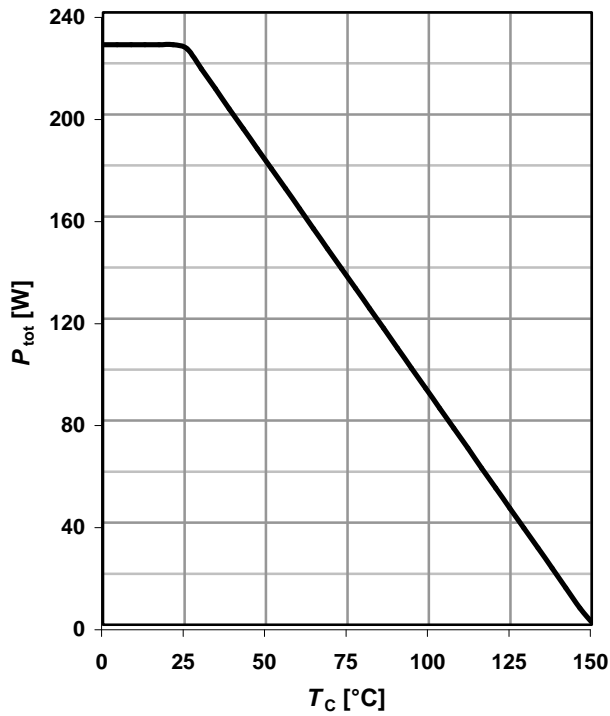

**2 Safe operating area**

$I_D=f(V_{DS}); T_C=25\text{ °C}; D=0$

parameter:  $t_p$

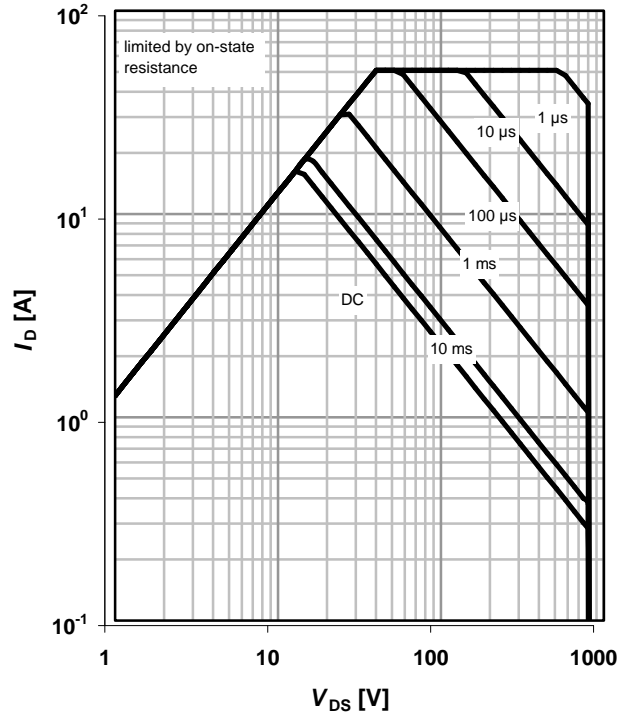

**3 Max. transient thermal impedance**

$Z_{thJC}=f(t_p)$

parameter:  $D=t_p/T$

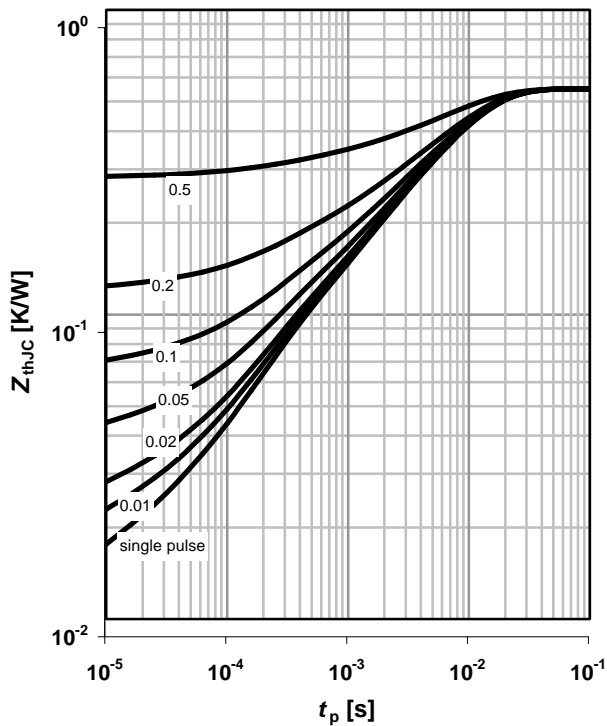

**4 Typ. output characteristics**

$I_D=f(V_{DS}); T_j=25\text{ °C}; t_p=10\text{ μs}$

parameter:  $V_{GS}$

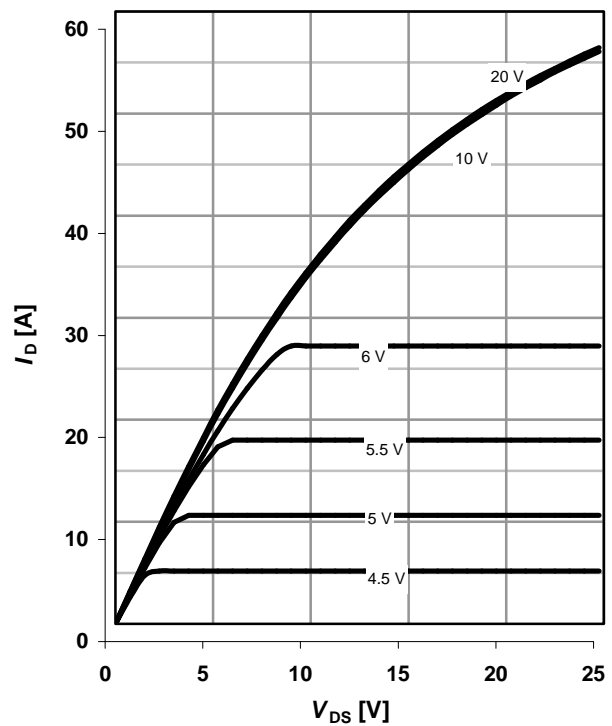

**5 Typ. output characteristics**

$I_D=f(V_{DS}); T_j=150\text{ }^\circ\text{C}; t_p=10\text{ }\mu\text{s}$

parameter:  $V_{GS}$

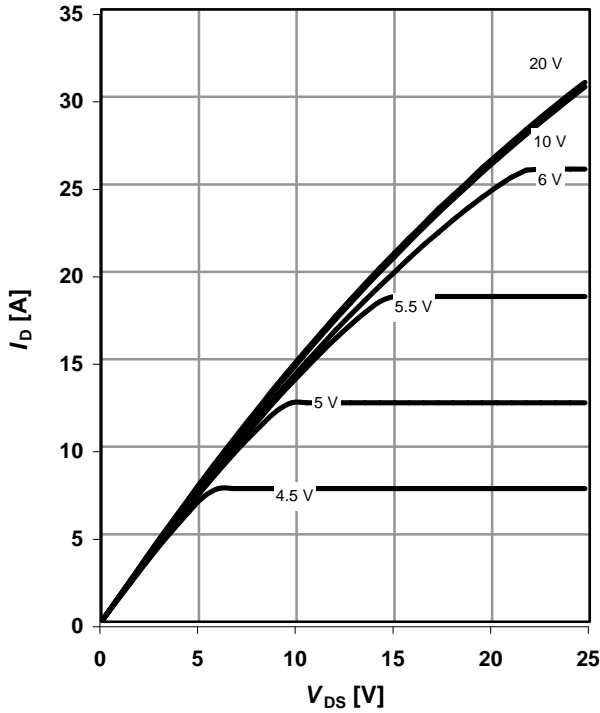

**6 Typ. drain-source on-state resistance**

$R_{DS(on)}=f(I_D); T_j=150\text{ }^\circ\text{C}$

parameter:  $V_{GS}$

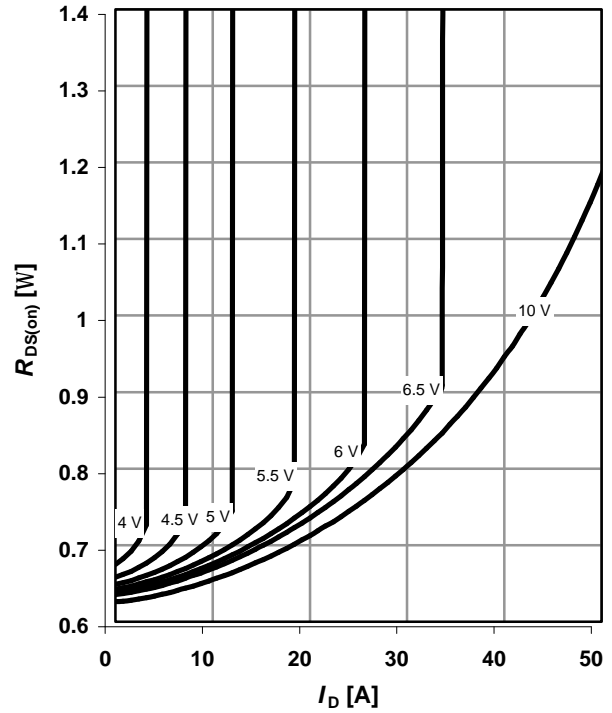

**7 Drain-source on-state resistance**

$R_{DS(on)}=f(T_j); I_D=11\text{ A}; V_{GS}=10\text{ V}$

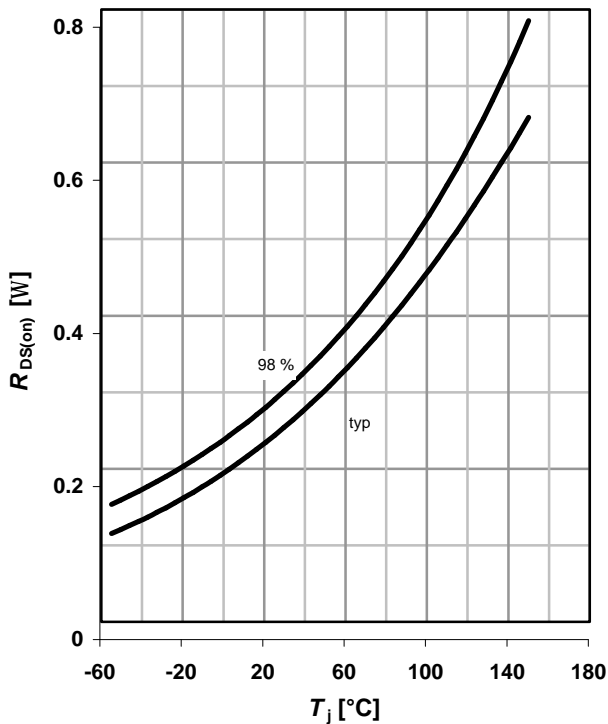

**8 Typ. transfer characteristics**

$I_D=f(V_{GS}); |V_{DS}|>2|I_D|R_{DS(on)max}; t_p=10\text{ }\mu\text{s}$

parameter:  $T_j$

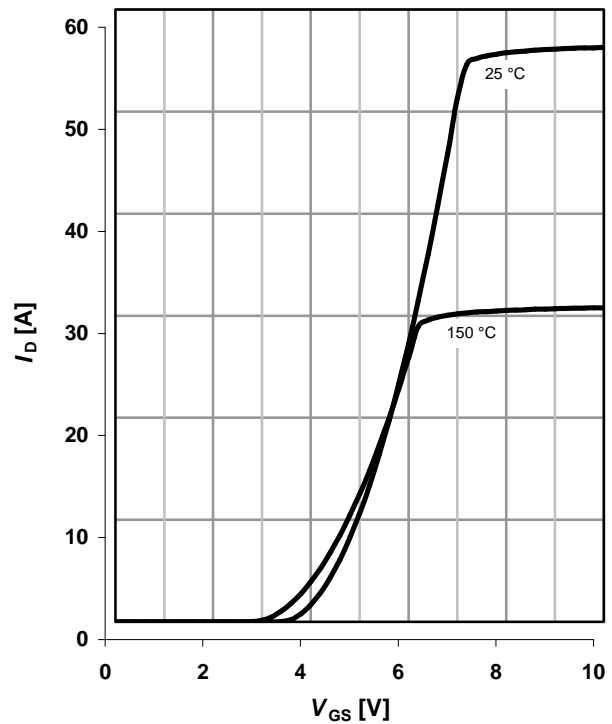

**9 Typ. gate charge**

$V_{GS}=f(Q_{gate}); I_D=17\text{ A pulsed}$

parameter:  $V_{DD}$

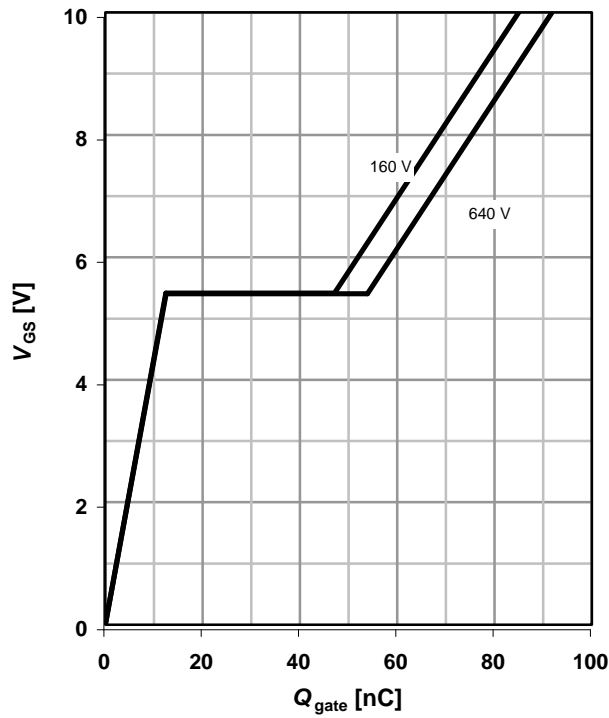

**10 Forward characteristics of reverse diode**

$I_F=f(V_{SD}); t_p=10\ \mu\text{s}$

parameter:  $T_j$

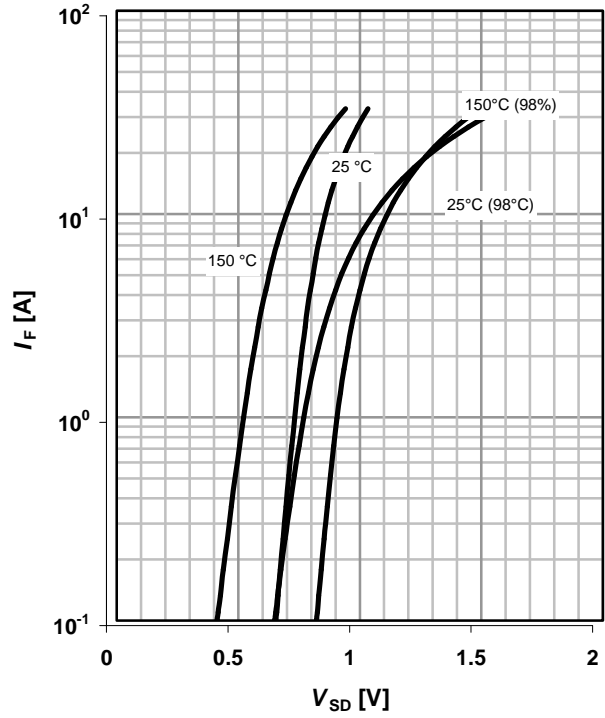

**11 Avalanche energy**

$E_{AS}=f(T_j); I_D=3.4\text{ A}; V_{DD}=50\text{ V}$

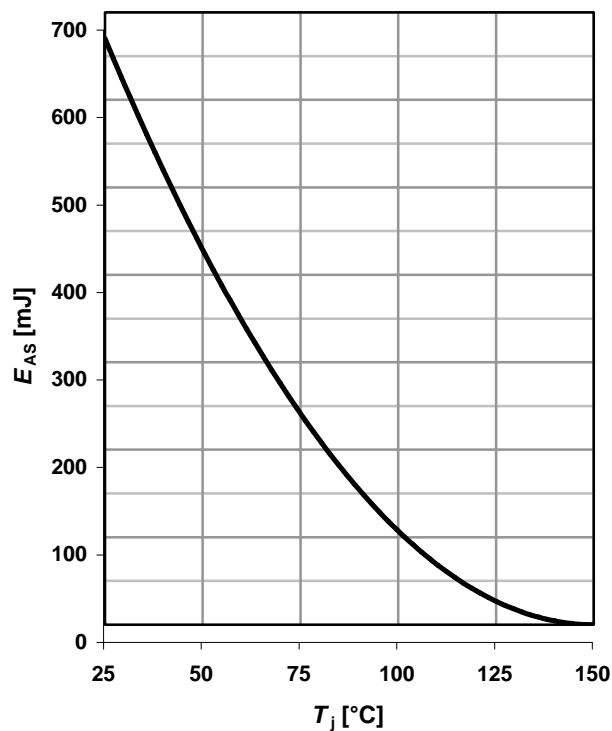

**12 Drain-source breakdown voltage**

$V_{BR(DSS)}=f(T_j); I_D=0.25\text{ mA}$



13 Typ. capacitances

$C=f(V_{DS}); V_{GS}=0\text{ V}; f=1\text{ MHz}$

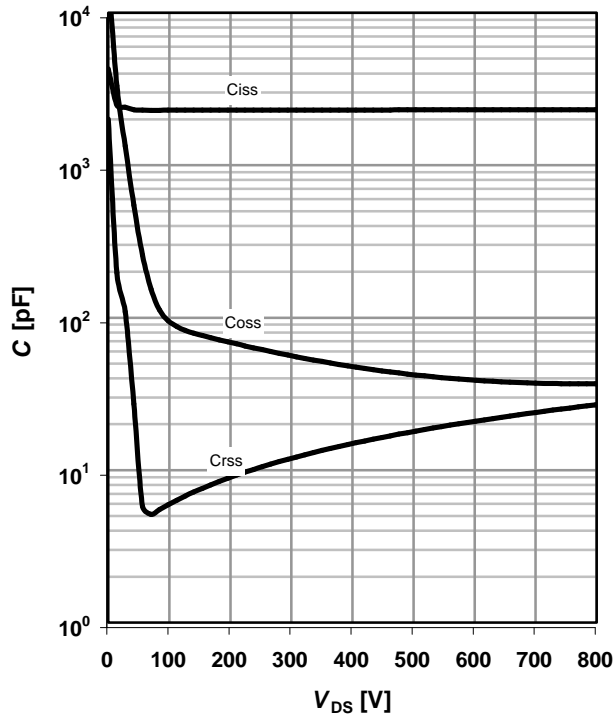

14 Typ. Coss stored energy

$E_{oss}=f(V_{DS})$

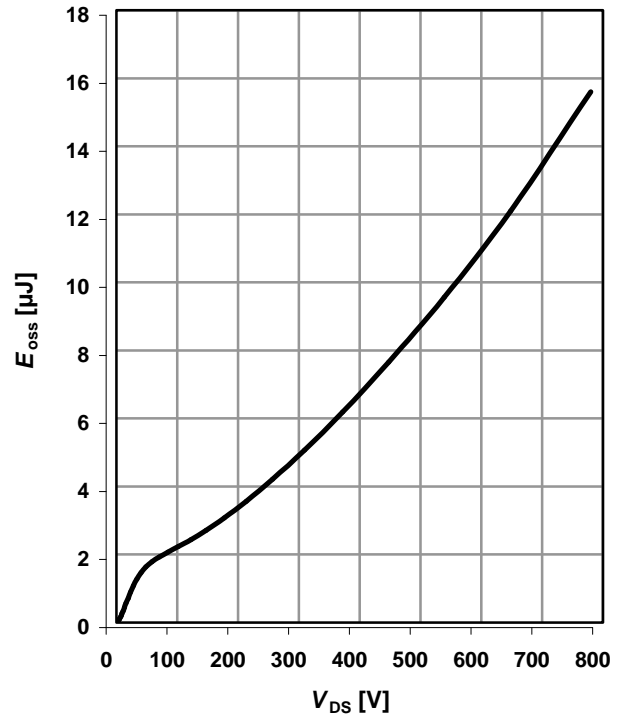

Definition of diode switching characteristics

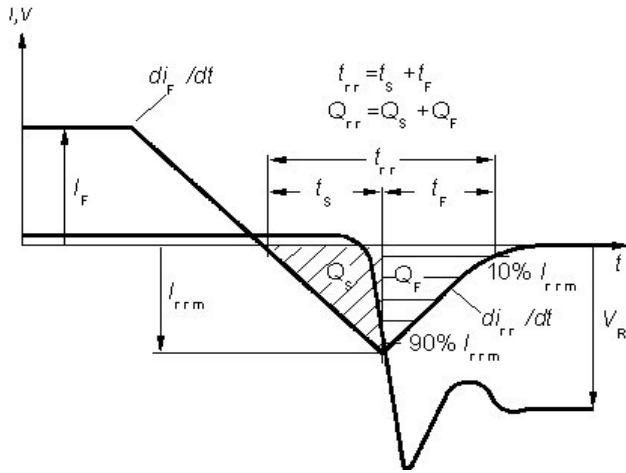



PG-TO220-3: Outline

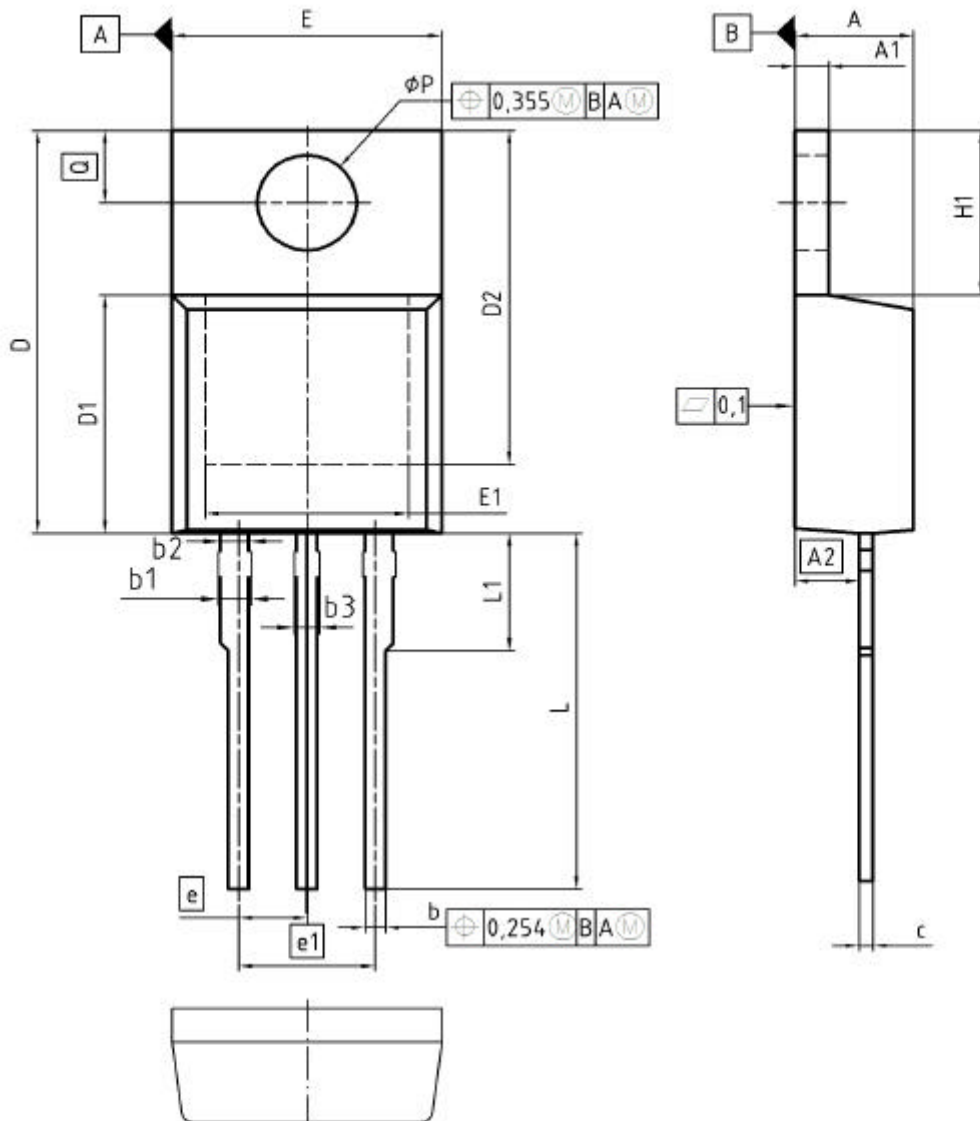

| DIM | MILLIMETERS |       | INCHES |       |
|-----|-------------|-------|--------|-------|
|     | MIN         | MAX   | MIN    | MAX   |
| A   | 4.30        | 4.57  | 0.169  | 0.180 |
| A1  | 1.17        | 1.40  | 0.046  | 0.055 |
| A2  | 2.15        | 2.72  | 0.085  | 0.107 |
| b   | 0.65        | 0.86  | 0.026  | 0.034 |
| b1  | 0.95        | 1.40  | 0.037  | 0.055 |
| b2  | 0.95        | 1.15  | 0.037  | 0.045 |
| b3  | 0.65        | 1.15  | 0.026  | 0.045 |
| c   | 0.33        | 0.60  | 0.013  | 0.024 |
| D   | 14.81       | 15.95 | 0.583  | 0.628 |
| D1  | 8.51        | 9.45  | 0.335  | 0.372 |
| D2  | 12.19       | 13.10 | 0.480  | 0.516 |
| E   | 9.70        | 10.36 | 0.382  | 0.408 |
| E1  | 6.50        | 8.60  | 0.256  | 0.339 |
| e   | 2.54        |       | 0.100  |       |
| e1  | 5.08        |       | 0.200  |       |
| N   | 3           |       | 3      |       |
| H1  | 5.90        | 6.90  | 0.232  | 0.272 |
| L   | 13.00       | 14.00 | 0.512  | 0.551 |
| L1  | -           | 4.80  | -      | 0.189 |
| eP  | 3.60        | 3.89  | 0.142  | 0.153 |
| Q   | 2.60        | 3.00  | 0.102  | 0.118 |

DOCUMENT NO.  
Z8B00003318

SCALE

EUROPEAN PROJECTION

ISSUE DATE  
23-08-2007

REVISION  
05

**Published by**  
**Infineon Technologies AG**  
**81726 Munich, Germany**  
**© 2008 Infineon Technologies AG**  
**All Rights Reserved.**

**Legal Disclaimer**

The information given in this document shall in no event be regarded as a guarantee of conditions or characteristics. With respect to any examples or hints given herein, any typical values stated herein and/or any information regarding the application of the device, Infineon Technologies hereby disclaims any and all warranties and liabilities of any kind, including without limitation, warranties of non-infringement of intellectual property rights of any third party.

**Information**

For further information on technology, delivery terms and conditions and prices, please [contact the nearest Infineon Technologies Office \(www.infineon.com\)](http://www.infineon.com).

**Warnings**

Due to technical requirements, components may contain dangerous substances. For information on the types in question, please contact the nearest Infineon Technologies Office. Infineon Technologies components may be used in life-support devices or systems only with the express written approval of Infineon Technologies, if a failure of such components can reasonably be expected to cause the failure of that life-support device or system or to affect the safety or effectiveness of that device or system. Life support devices or systems are intended to be implanted in the human body or to support and/or maintain and sustain and/or protect human life. If they fail, it is reasonable to assume that the health of the user or other persons may be endangered.