

MMBT589LT1G

High Current Surface Mount PNP Silicon Switching Transistor for Load Management in Portable Applications

Features

- These Devices are Pb-Free, Halogen Free/BFR Free and are RoHS Compliant

MAXIMUM RATINGS ($T_A = 25^\circ\text{C}$)

| Rating | Symbol | Value | Unit |
|--------------------------------|-----------|-------|------|
| Collector - Emitter Voltage | V_{CEO} | -30 | Vdc |
| Collector - Base Voltage | V_{CBO} | -50 | Vdc |
| Emitter - Base Voltage | V_{EBO} | -5.0 | Vdc |
| Collector Current - Continuous | I_C | -1.0 | Adc |
| Collector Current - Peak | I_{CM} | -2.0 | A |

THERMAL CHARACTERISTICS

| Characteristic | Symbol | Max | Unit |
|---|----------------------|-------------|----------------------------|
| Total Device Dissipation FR-5 Board, (Note 1) $T_A = 25^\circ\text{C}$ Derate above 25°C | P_D | 310 2.5 | mW mW/ $^\circ\text{C}$ |
| Thermal Resistance, Junction-to-Ambient (Note 1) | $R_{\theta JA}$ | 403 | $^\circ\text{C}/\text{W}$ |
| Total Device Dissipation Alumina Substrate, (Note 2) $T_A = 25^\circ\text{C}$ Derate above 25°C | P_D | 710 5.7 | mW mW/ $^\circ\text{C}$ |
| Thermal Resistance, Junction-to-Ambient (Note 2) | $R_{\theta JA}$ | 176 | $^\circ\text{C}/\text{W}$ |
| Total Device Dissipation (Ref. Figure 8) (Single Pulse < 10 sec.) | $P_{D\text{single}}$ | 575 | mW |
| Junction and Storage Temperature | T_J, T_{stg} | -55 to +150 | $^\circ\text{C}$ |

Stresses exceeding Maximum Ratings may damage the device. Maximum Ratings are stress ratings only. Functional operation above the Recommended Operating Conditions is not implied. Extended exposure to stresses above the Recommended Operating Conditions may affect device reliability.

1. FR-4 @ Minimum Pad
2. FR-4 @ 1.0 X 1.0 inch Pad



ON Semiconductor®

<http://onsemi.com>

30 VOLTS, 2.0 AMPS PNP TRANSISTORS

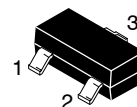
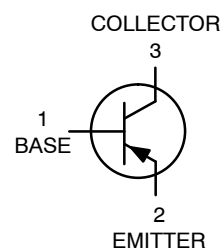

SOT-23 (TO-236)
CASE 318
STYLE 6

MARKING DIAGRAM

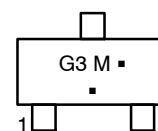

G3 = Device Code
M = Date Code*
■ = Pb-Free Package

(Note: Microdot may be in either location)

*Date Code orientation and/or overbar may vary depending upon manufacturing location.

ORDERING INFORMATION

| Device | Package | Shipping† |
|-------------|---------------------|---------------------|
| MMBT589LT1G | SOT-23 (Pb-Free) | 3,000 / Tape & Reel |

†For information on tape and reel specifications, including part orientation and tape sizes, please refer to our Tape and Reel Packaging Specifications Brochure, BRD8011/D.

MMBT589LT1G

ELECTRICAL CHARACTERISTICS ($T_A = 25^\circ\text{C}$ unless otherwise noted)

| Characteristic | Symbol | Min | Max | Unit |
|--|---------------|------------------------|-------------------------|-----------------|
| OFF CHARACTERISTICS | | | | |
| Collector - Emitter Breakdown Voltage ($I_C = -10 \text{ mA}$, $I_B = 0$) | $V_{(BR)CEO}$ | -30 | - | Vdc |
| Collector - Base Breakdown Voltage ($I_C = -0.1 \text{ mA}$, $I_E = 0$) | $V_{(BR)CBO}$ | -50 | - | Vdc |
| Emitter - Base Breakdown Voltage ($I_E = -0.1 \text{ mA}$, $I_C = 0$) | $V_{(BR)EBO}$ | -5.0 | - | Vdc |
| Collector Cutoff Current ($V_{CB} = -30 \text{ Vdc}$, $I_E = 0$) | I_{CBO} | - | -0.1 | μAdc |
| Collector - Emitter Cutoff Current ($V_{CES} = -30 \text{ Vdc}$) | I_{CES} | - | -0.1 | μAdc |
| Emitter Cutoff Current ($V_{EB} = -4.0 \text{ Vdc}$) | I_{EBO} | - | -0.1 | μAdc |
| ON CHARACTERISTICS | | | | |
| DC Current Gain (Note 3) (Figure 1) ($I_C = -1.0 \text{ mA}$, $V_{CE} = -2.0 \text{ V}$) ($I_C = -500 \text{ mA}$, $V_{CE} = -2.0 \text{ V}$) ($I_C = -1.0 \text{ A}$, $V_{CE} = -2.0 \text{ V}$) ($I_C = 2.0 \text{ A}$, $V_{CE} = -2.0 \text{ V}$) | h_{FE} | 100 100 80 40 | - 300 - - | - |
| Collector - Emitter Saturation Voltage (Note 3) (Figure 3) ($I_C = -0.5 \text{ A}$, $I_B = -0.05 \text{ A}$) ($I_C = -1.0 \text{ A}$, $I_B = 0.1 \text{ A}$) ($I_C = -2.0 \text{ A}$, $I_B = -0.2 \text{ A}$) | $V_{CE(sat)}$ | - - - | -0.25 -0.30 -0.65 | V |
| Base - Emitter Saturation Voltage (Note 3) (Figure 2) ($I_C = -1.0 \text{ A}$, $I_B = -0.1 \text{ A}$) | $V_{BE(sat)}$ | - | -1.2 | V |
| Base - Emitter Turn-on Voltage (Note 3) ($I_C = -1.0 \text{ A}$, $V_{CE} = -2.0 \text{ V}$) | $V_{BE(on)}$ | - | -1.1 | V |
| Cutoff Frequency ($I_C = -100 \text{ mA}$, $V_{CE} = -5.0 \text{ V}$, $f = 100 \text{ MHz}$) | f_T | 100 | - | MHz |
| Output Capacitance ($f = 1.0 \text{ MHz}$) | Cobo | - | 15 | pF |

3. Pulsed Condition: Pulse Width = 300 msec, Duty Cycle $\leq 2\%$

MMBT589LT1G

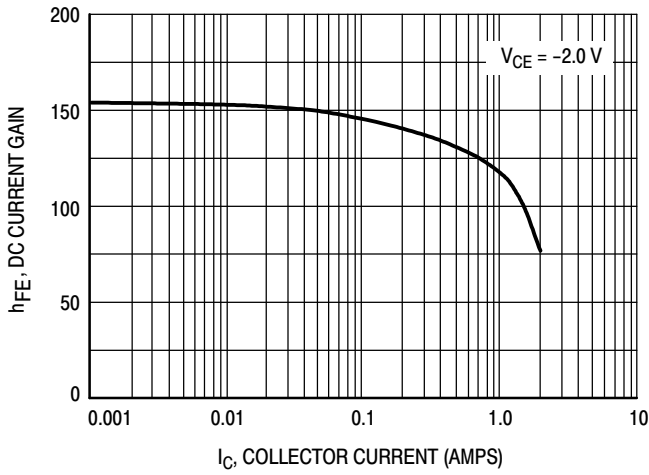

Figure 1. DC Current Gain versus Collector Current

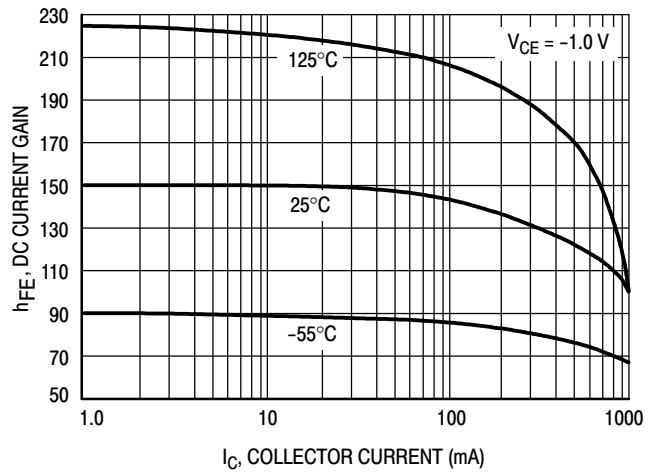

Figure 2. DC Current Gain versus Collector Current

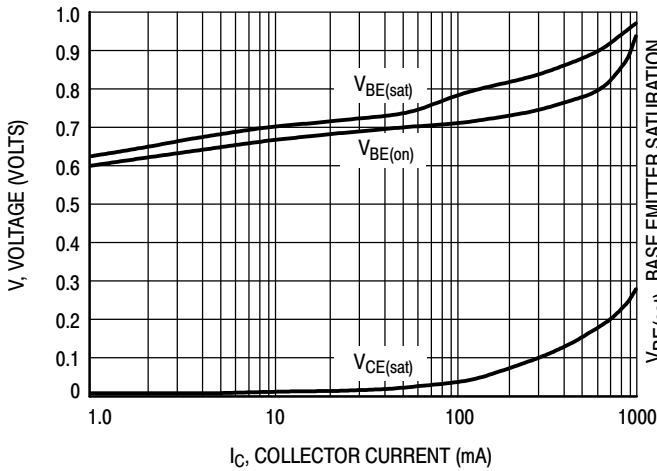

Figure 3. "On" Voltages

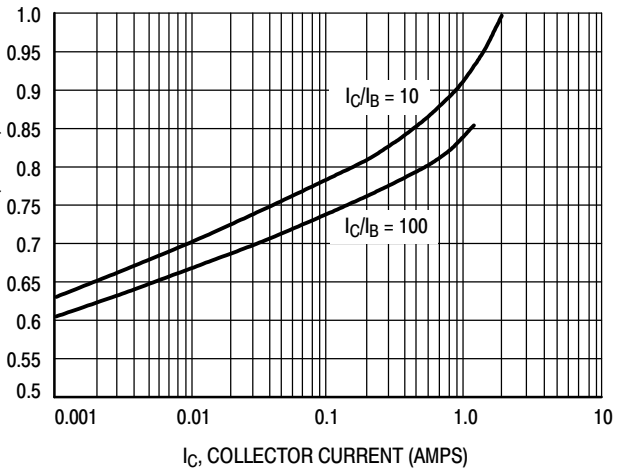

Figure 4. Base Emitter Saturation Voltage versus Collector Current

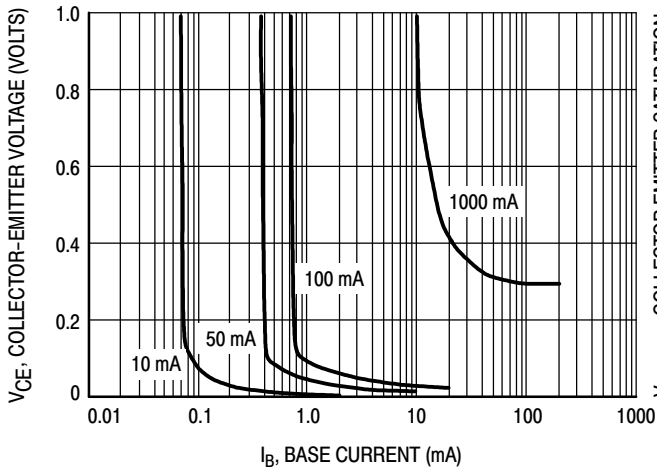

Figure 5. Collector Emitter Saturation Voltage versus Collector Current

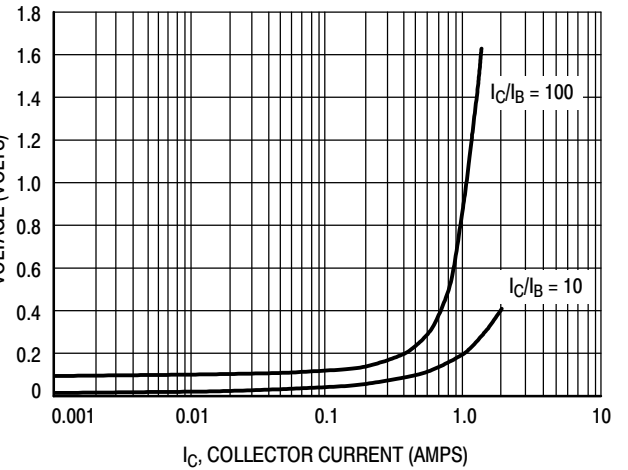

Figure 6. Collector Emitter Saturation Voltage versus Collector Current

MMBT589LT1G

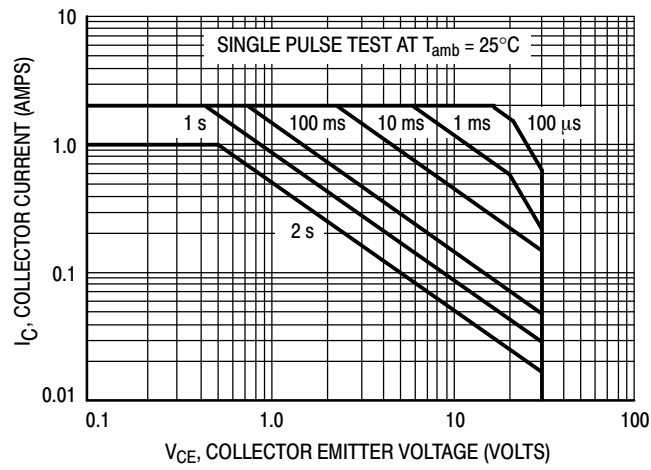

Figure 7. Safe Operating Area

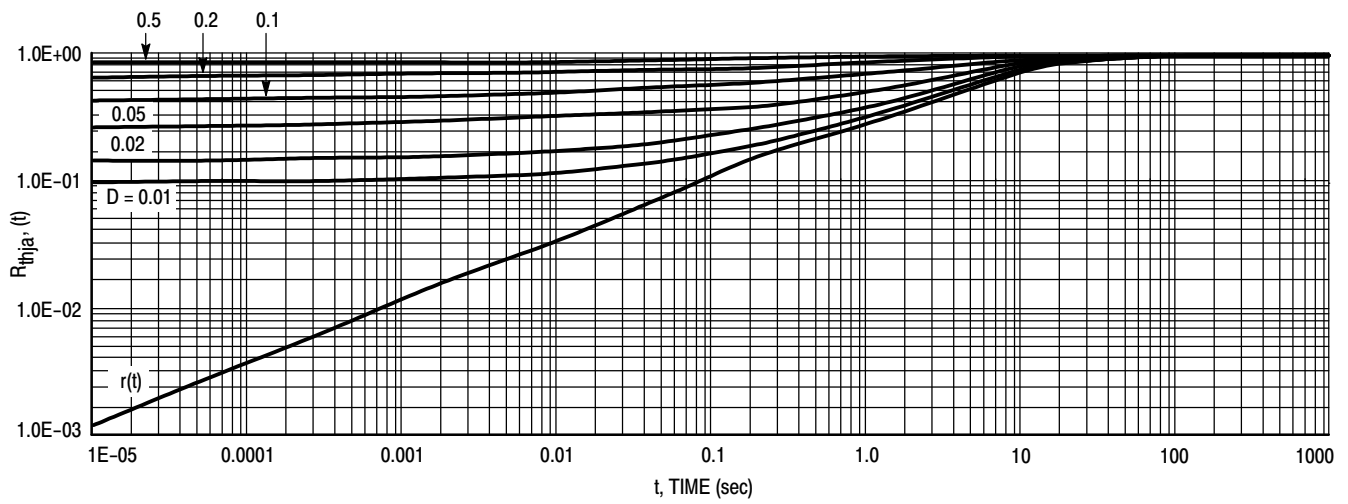
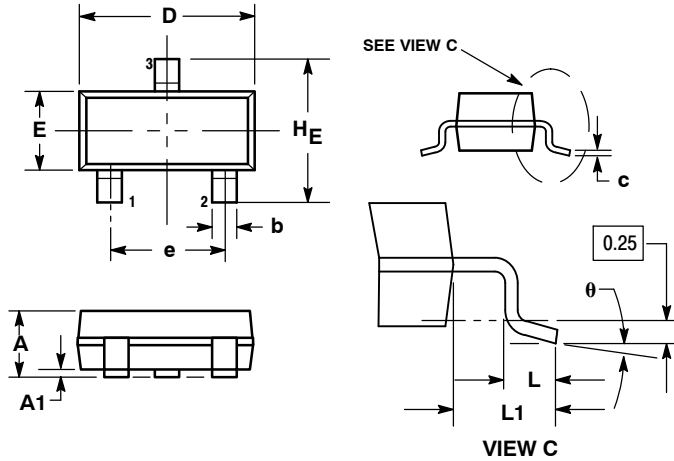

Figure 8. Normalized Thermal Response

MMBT589LT1G

PACKAGE DIMENSIONS

SOT-23 (TO-236)
CASE 318-08
ISSUE AN



NOTES:

1. DIMENSIONING AND TOLERANCING PER ANSI Y14.5M, 1982.
2. CONTROLLING DIMENSION: INCH.
3. MAXIMUM LEAD THICKNESS INCLUDES LEAD FINISH THICKNESS. MINIMUM LEAD THICKNESS IS THE MINIMUM THICKNESS OF BASE MATERIAL.
4. 318-01 THRU -07 AND -09 OBSOLETE, NEW STANDARD 318-08.

| DIM | MILLIMETERS | | | INCHES | | |
|-----|-------------|------|------|--------|-------|-------|
| | MIN | NOM | MAX | MIN | NOM | MAX |
| A | 0.89 | 1.00 | 1.11 | 0.035 | 0.040 | 0.044 |
| A1 | 0.01 | 0.06 | 0.10 | 0.001 | 0.002 | 0.004 |
| b | 0.37 | 0.44 | 0.50 | 0.015 | 0.018 | 0.020 |
| c | 0.09 | 0.13 | 0.18 | 0.003 | 0.005 | 0.007 |
| D | 2.80 | 2.90 | 3.04 | 0.110 | 0.114 | 0.120 |
| E | 1.20 | 1.30 | 1.40 | 0.047 | 0.051 | 0.055 |
| e | 1.78 | 1.90 | 2.04 | 0.070 | 0.075 | 0.081 |
| L | 0.10 | 0.20 | 0.30 | 0.004 | 0.008 | 0.012 |
| L1 | 0.35 | 0.54 | 0.69 | 0.014 | 0.021 | 0.029 |
| HE | 2.10 | 2.40 | 2.64 | 0.083 | 0.094 | 0.104 |

STYLE 6:

1. BASE
2. EMITTER
3. COLLECTOR

SOLDERING FOOTPRINT*

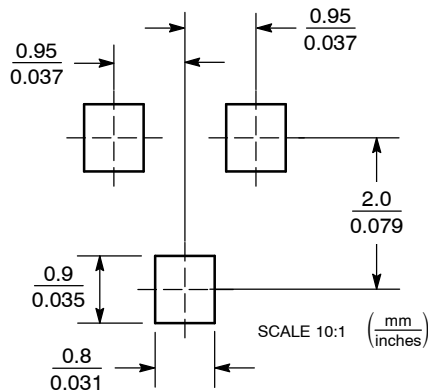

*For additional information on our Pb-Free strategy and soldering details, please download the ON Semiconductor Soldering and Mounting Techniques Reference Manual, SOLDERRM/D.

ON Semiconductor and are registered trademarks of Semiconductor Components Industries, LLC (SCILLC). SCILLC reserves the right to make changes without further notice to any products herein. SCILLC makes no warranty, representation or guarantee regarding the suitability of its products for any particular purpose, nor does SCILLC assume any liability arising out of the application or use of any product or circuit, and specifically disclaims any and all liability, including without limitation special, consequential or incidental damages. "Typical" parameters which may be provided in SCILLC data sheets and/or specifications can and do vary in different applications and actual performance may vary over time. All operating parameters, including "Typicals" must be validated for each customer application by customer's technical experts. SCILLC does not convey any license under its patent rights nor the rights of others. SCILLC products are not designed, intended, or authorized for use as components in systems intended for surgical implant into the body, or other applications intended to support or sustain life, or for any other application in which the failure of the SCILLC product could create a situation where personal injury or death may occur. Should Buyer purchase or use SCILLC products for any such unintended or unauthorized application, Buyer shall indemnify and hold SCILLC and its officers, employees, subsidiaries, affiliates, and distributors harmless against all claims, costs, damages, and expenses, and reasonable attorney fees arising out of, directly or indirectly, any claim of personal injury or death associated with such unintended or unauthorized use, even if such claim alleges that SCILLC was negligent regarding the design or manufacture of the part. SCILLC is an Equal Opportunity/Affirmative Action Employer. This literature is subject to all applicable copyright laws and is not for resale in any manner.

PUBLICATION ORDERING INFORMATION

LITERATURE FULFILLMENT:
Literature Distribution Center for ON Semiconductor
P.O. Box 5163, Denver, Colorado 80217 USA
Phone: 303-675-2175 or 800-344-3860 Toll Free USA/Canada
Fax: 303-675-2176 or 800-344-3867 Toll Free USA/Canada
Email: orderlit@onsemi.com

N. American Technical Support: 800-282-9855 Toll Free
USA/Canada
Europe, Middle East and Africa Technical Support:
Phone: 421 33 790 2910
Japan Customer Focus Center
Phone: 81-3-5773-3850

ON Semiconductor Website: www.onsemi.com

Order Literature: <http://www.onsemi.com/orderlit>

For additional information, please contact your local Sales Representative