

# 32V<sub>IN</sub>, 2A $\mu$ Module Power Tracking Battery Charger

## FEATURES

- Complete Battery Charger System
- Input Supply Voltage Regulation Loop for Peak Power Tracking in MPPT (Maximum Peak Power Tracking) Solar Applications
- Wide Input Voltage Range: 4.95V to 32V (40V Abs Max)
- 2A Charge Current
- Resistor Programmable Float Voltage Up to 14.4V Accommodates Li-Ion/Polymer, LiFePO<sub>4</sub>, SLA
- Integrated Input Reverse Voltage Protection
- User Selectable Termination: C/10 or Termination Timer
- 0.75% Float Voltage Reference Accuracy
- 9mm × 15mm × 4.32mm LGA Package

## APPLICATIONS

- Industrial Handheld Instruments
- 12V to 24V Automotive and Heavy Equipment
- Desktop Cradle Chargers
- Solar Power Battery Charging

## DESCRIPTION

The LTM<sup>®</sup>8062 is a complete 32V<sub>IN</sub>, 2A  $\mu$ Module<sup>®</sup> power tracking battery charger. The LTM8062 provides a constant-current/constant-voltage charge characteristic, a 2A maximum charge current, and employs a 3.3V float voltage feedback reference, so any desired battery float voltage up to 14.4V can be programmed with a resistor divider.

The LTM8062 employs an input voltage regulation loop, which reduces charge current if the input voltage falls below a programmed level, set with a resistor divider. When the LTM8062 is powered by a solar panel, this input regulation loop is used to maintain the panel at peak output power. The LTM8062 also features preconditioning trickle charge, bad battery detection, a choice of termination schemes and automatic restart.

The LTM8062 is packaged in a thermally enhanced, compact (9mm × 15mm × 4.32mm) over-molded land grid array (LGA) package suitable for automated assembly by standard surface mount equipment. The LTM8062 is RoHS compliant.

LT, LT, LTC, LTM, Linear Technology, the Linear logo and  $\mu$ Module are registered trademarks of Linear Technology Corporation. All other trademarks are the property of their respective owners.

## TYPICAL APPLICATION

2A LiFePO<sub>4</sub>  $\mu$ Module Battery Charger

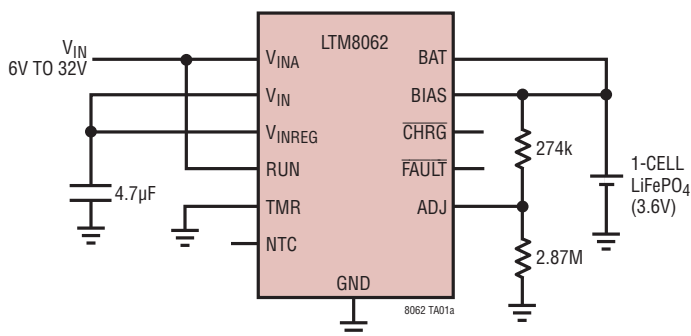

Charge Current vs Battery Voltage

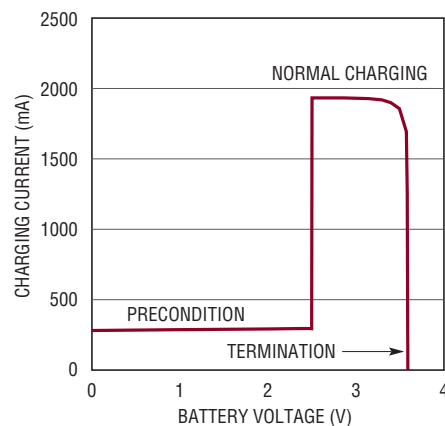

8062 TA01b

# LTM8062

## ABSOLUTE MAXIMUM RATINGS

(Note 1)

$V_{INA}, V_{IN}$ .....	40V
$V_{INREG}, RUN, CHRG, \overline{FAULT}$ .....	$V_{IN} + 0.5, 40V$
TMR, NTC .....	2.5V
BAT .....	15V
BIAS .....	10V
ADJ .....	5V
Maximum Internal Operating Temperature (Note 2).....	125°C
Maximum Body Solder Temperature.....	245°C

## PIN CONFIGURATION

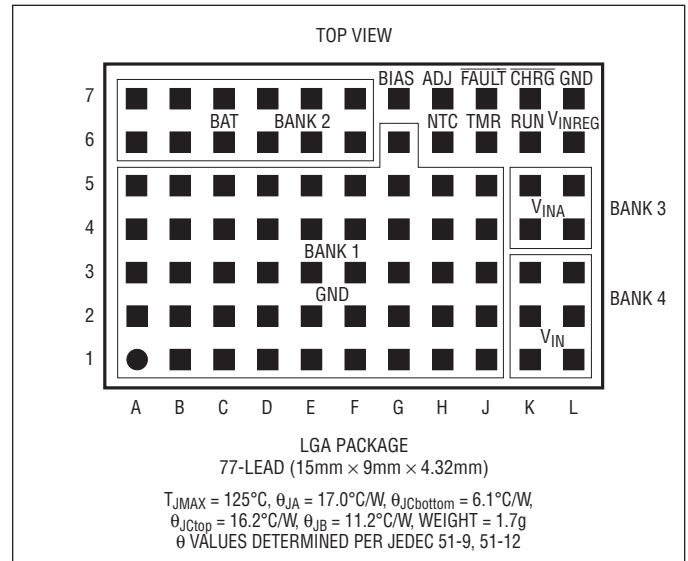

## ORDER INFORMATION

LEAD FREE FINISH	TRAY	PART MARKING*	PACKAGE DESCRIPTION	TEMPERATURE RANGE
LTM8062EV#PBF	LTM8062EV#PBF	LTM8062V	77-Lead (15mm × 9mm × 4.32mm) LGA	-40°C to 125°C
LTM8062IV#PBF	LTM8062IV#PBF	LTM8062V	77-Lead (15mm × 9mm × 4.32mm) LGA	-40°C to 125°C

Consult LTC Marketing for parts specified with wider operating temperature ranges. \*The temperature grade is identified by a label on the shipping container.

For more information on lead free part marking, go to: <http://www.linear.com/leadfree/>

This product is only offered in trays. For more information go to: <http://www.linear.com/packaging/>

## ELECTRICAL CHARACTERISTICS

The ● denotes the specifications which apply over the full internal operating temperature range, otherwise specifications are at  $T_A = 25^\circ\text{C}$ . RUN = 2V.

PARAMETER	CONDITIONS	MIN	TYP	MAX	UNITS
$V_{IN}$ Maximum Operating Voltage				32	V
$V_{IN}$ Start Voltage		● 7.5			V
$V_{IN}$ OVLO Threshold	$V_{IN}$ Rising	32	35	40	V
$V_{IN}$ OVLO Hysteresis			1		V
$V_{IN}$ UVLO Threshold	$V_{IN}$ Rising		4.6		V
$V_{IN}$ UVLO Hysteresis			0.3		V
$V_{INA}$ to $V_{IN}$ Diode Forward Voltage Drop	$V_{INA}$ Current = 2A		0.55		V
Maximum BAT Float Voltage	$I_{BAT} = 2A$			14.7	V
Input Supply Current	Standby Mode RUN = 0, $V_{IN}$ Reg Open		85 18		$\mu\text{A}$ $\mu\text{A}$
Maximum BAT Charging Current	(Note 3)	1.8		2.1	A
ADJ Float Reference Voltage	(Note 4)	● 3.275 3.25	3.3	3.325 3.34	V V
ADJ Recharge Threshold Voltage	Threshold Relative to ADJ Float Reference (Note 3)		82.5		mV
ADJ Precondition Threshold Voltage	ADJ Rising (Note 4)		2.3		V
ADJ Precondition Threshold Hysteresis Voltage	Relative to ADJ Precondition Threshold (Note 4)		95		mV
ADJ Input Bias Current	Charging Terminated CV Operation (Note 5)		65 110		nA nA
$V_{INREG}$ Reference Voltage	ADJ = 3V, $I_{BAT} = 1A$	● 2.61	2.7	2.83	V
$V_{INREG}$ Bias Current	$V_{INREG} = V_{INREG}$ Reference		35	100	nA
NTC Range Limit (High) Voltage	$V_{NTC}$ Rising	1.25	1.36	1.45	V
NTC Range Limit (Low) Voltage	$V_{NTC}$ Falling	0.27	0.29	0.315	V
NTC Disable Impedance		250	500		$k\Omega$
NTC Bias Current	$V_{NTC} = 0.8V$	45		53	$\mu\text{A}$
NTC Threshold Hysteresis	For Both High and Low Range Limits		20		%
RUN Threshold Voltage	$V_{RUN}$ Rising	1.15	1.20	1.25	V
RUN Hysteresis Voltage			120		mV
RUN Input Bias Current			-10		nA
CHRG, FAULT Output Low Voltage	10mA Load			0.4	V
TMR Charge/Discharge Current			25		$\mu\text{A}$
TMR Disable Threshold Voltage			0.25		V
Operating Frequency		0.85	1	1.15	MHz

**Note 1:** Stresses beyond those listed under Absolute Maximum Ratings may cause permanent damage to the device. Exposure to any Absolute Maximum Rating condition for extended periods may affect device reliability and lifetime.

**Note 2:** The LTM8062E is guaranteed to meet performance specifications from  $0^\circ\text{C}$  to  $125^\circ\text{C}$  internal. Specifications over the full  $-40^\circ\text{C}$  to  $125^\circ\text{C}$  internal operating temperature range are assured by design, characterization and correlation with statistical process controls. The LTM8062I is guaranteed to meet specifications over the full  $-40^\circ\text{C}$  to

$125^\circ\text{C}$  internal operating temperature range. Note that the maximum internal temperature is determined by specific operating conditions in conjunction with board layout, the rated package thermal resistance and other environmental factors.

**Note 3:** The maximum BAT charging current is reduced by thermal foldback. See the Typical Performance Characteristics for details.

**Note 4:** ADJ voltages measured through 250k equivalent series resistance.

**Note 5:** Output battery float voltage programming resistor divider equivalent resistance = 250k compensates for input bias current.

**TYPICAL PERFORMANCE CHARACTERISTICS**  $T_A = 25^\circ\text{C}$ , unless otherwise noted.

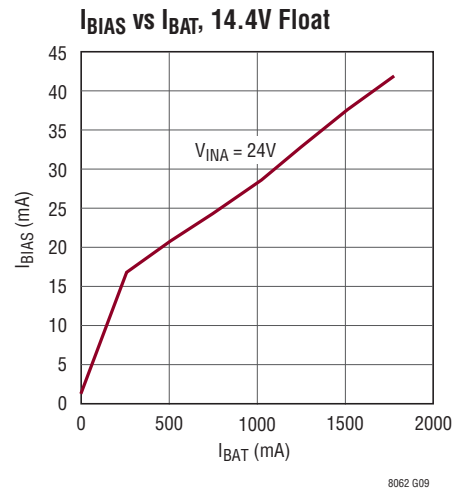
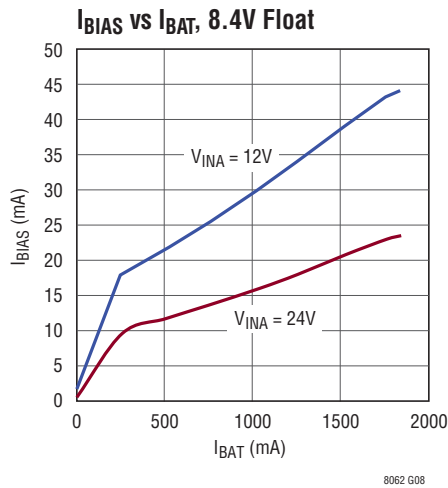
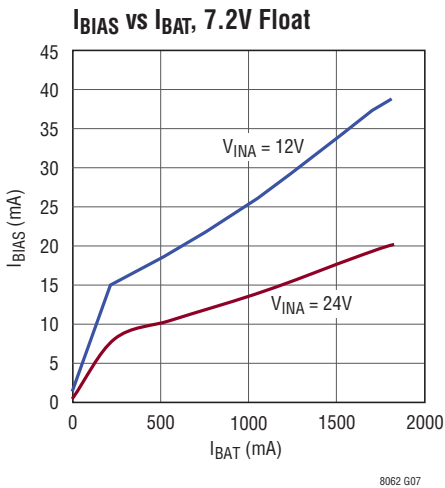
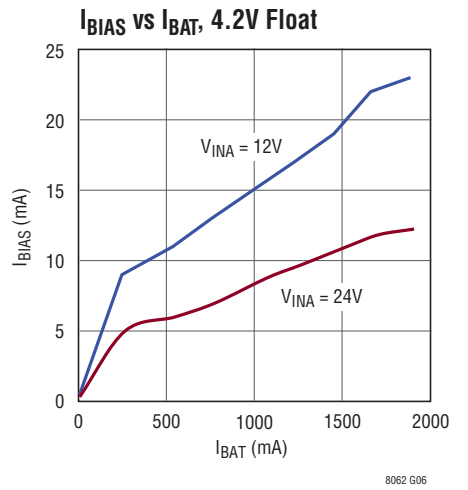
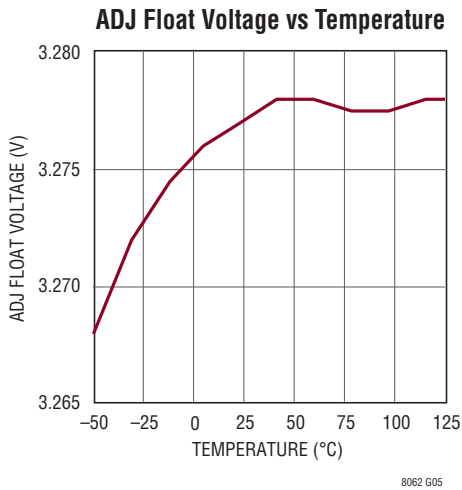
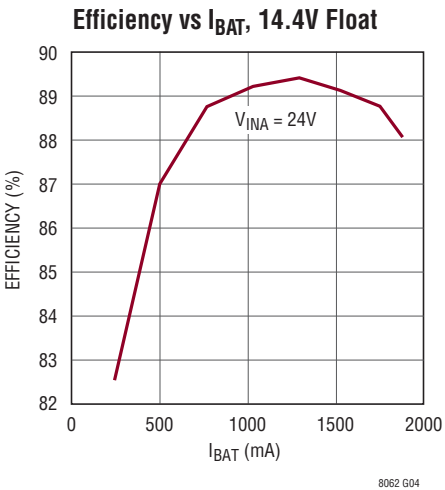
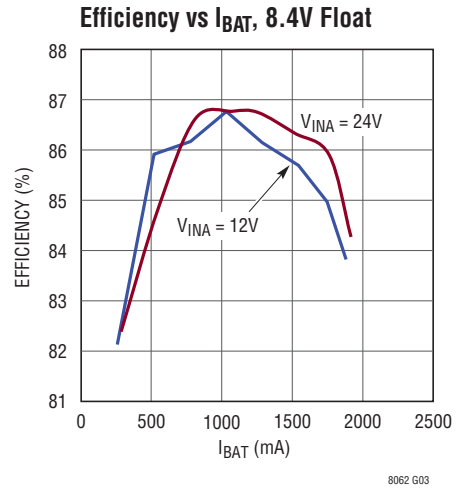
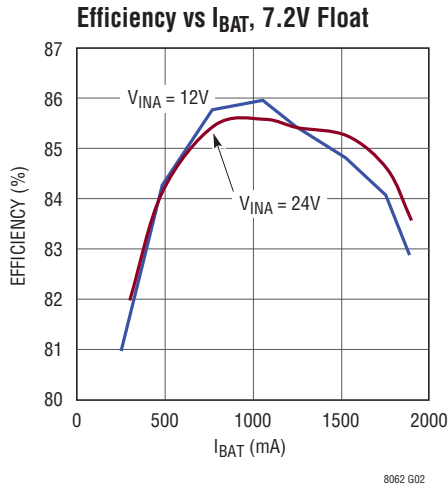
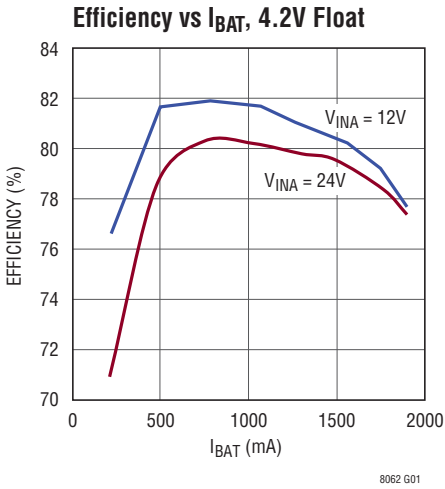

**TYPICAL PERFORMANCE CHARACTERISTICS**  $T_A = 25^\circ\text{C}$ , unless otherwise noted.

**Input Current vs  $I_{BAT}$ , 4.2V Float**

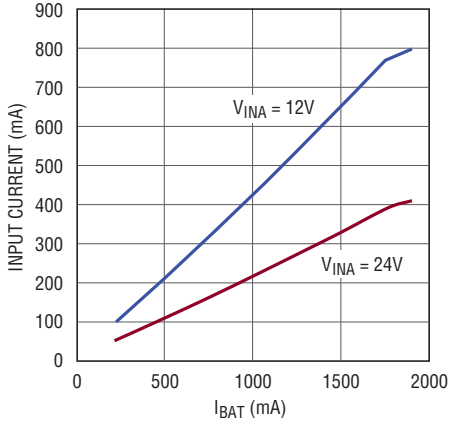

8062 G10

**Input Current vs  $I_{BAT}$ , 7.2V Float**

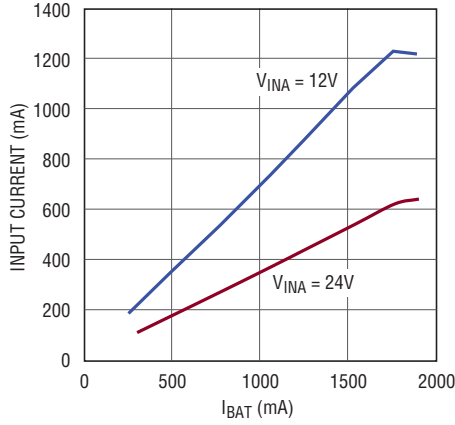

8062 G11

**Input Current vs  $I_{BAT}$ , 8.4V Float**

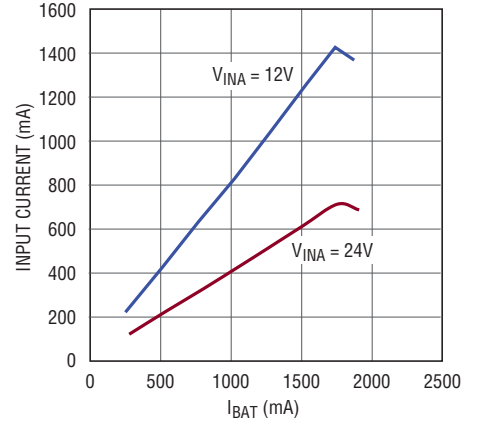

8062 G12

**Input Current vs  $I_{BAT}$ , 14.4V Float**

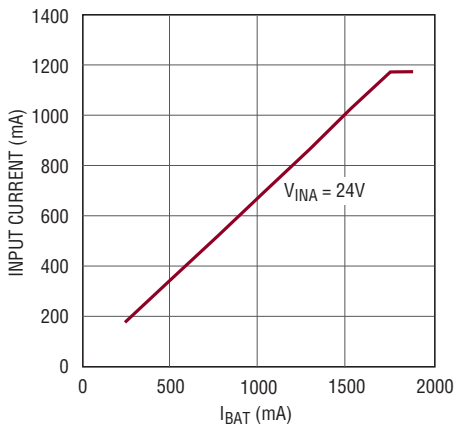

8062 G13

**$I_Q$  vs  $V_{INA}$ , RUN = 0V,  $V_{INREG}$  Open**

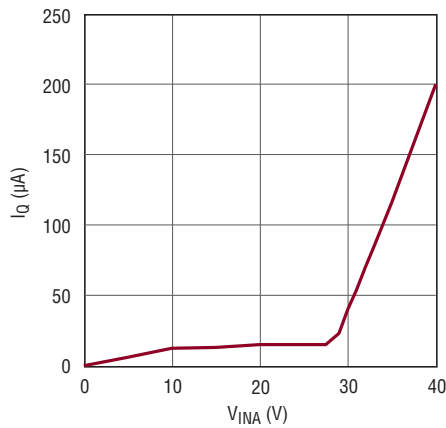

8062 G14

**Maximum  $I_{BAT}$  vs ADJ**

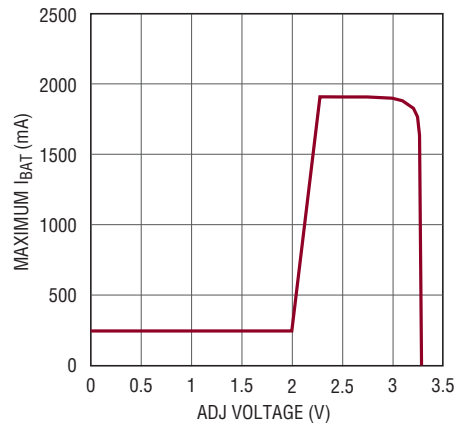

8062 G15

**Maximum  $I_{BAT}$  vs  $V_{INREG}$**

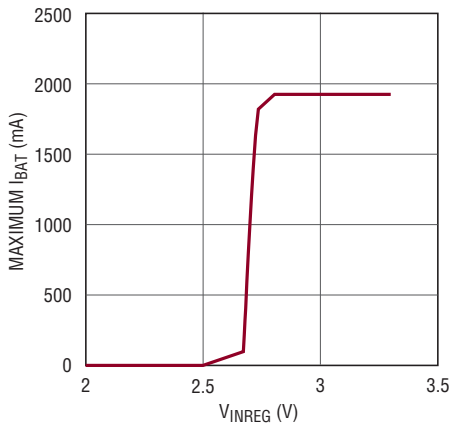

8062 G16

**Maximum Charge Current vs Temperature**

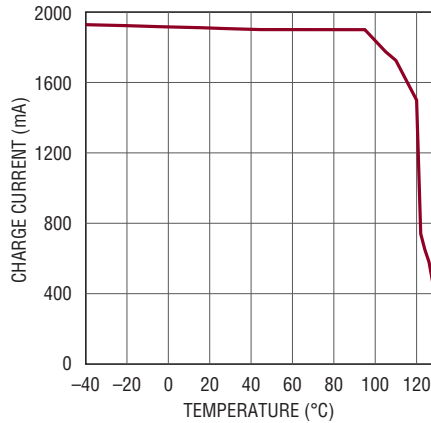

8062 G17

**Temperature Rise vs  $I_{BAT}$ , 4.2V Float Voltage**

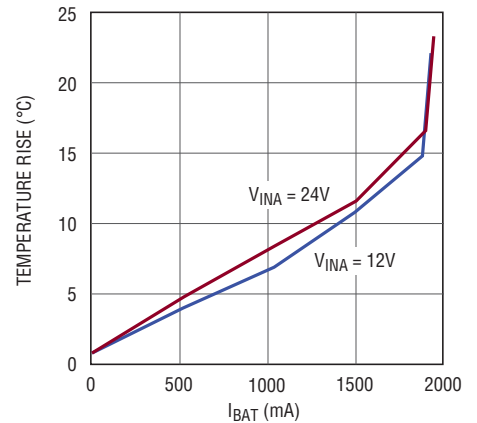

8062 G18

## TYPICAL PERFORMANCE CHARACTERISTICS $T_A = 25^\circ\text{C}$ , unless otherwise noted.

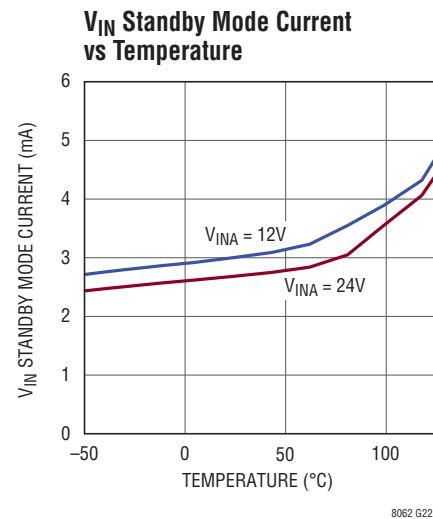
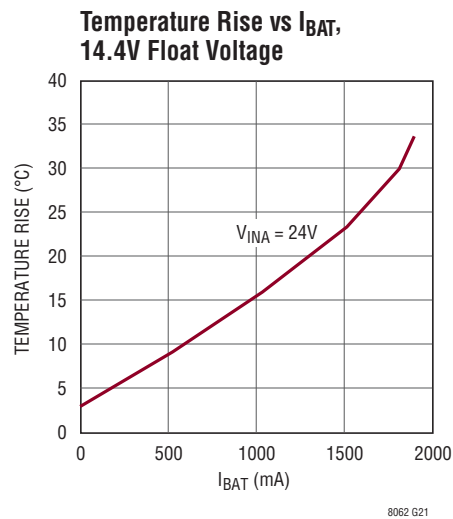
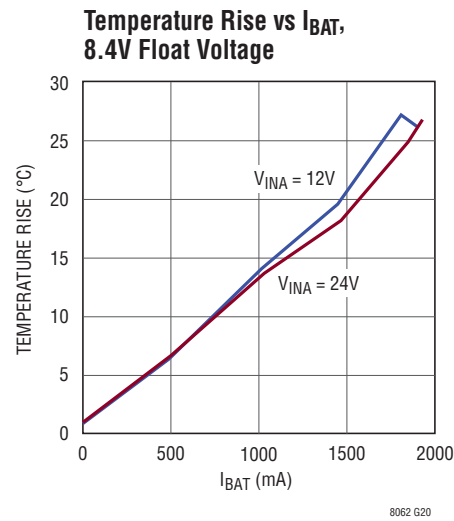
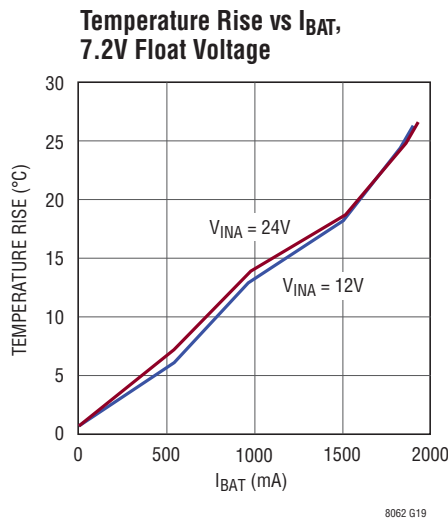

## PIN FUNCTIONS

**GND (Bank 1, Pin L7):** Power and Signal Ground Return.

**BAT (Bank 2):** Battery Charge Current Output Bus. The charge function operates to achieve the final float voltage at this pin. The auto-restart feature initiates a new charging cycle when the voltage at the ADJ pin falls 2.5% below the float voltage. Once the charge cycle is terminated, the input bias current of the BAT pin is reduced to minimize battery discharge while the charger remains connected.

**$V_{\text{INA}}$  (Bank 3):** Anode of input reverse protection Schottky diode. Connect the input power here if input reverse voltage protection is desired.

**$V_{\text{IN}}$  (Bank 4):** Charger Input Supply. Decouple with at least  $4.7\mu\text{F}$  to GND. Connect the input power here if no input reverse voltage protection is needed.

**BIAS (Pin G7):** The BIAS pin connects to the internal power bus. In most cases connect to  $V_{\text{BAT}}$ . If this is not desirable, connect to a power source greater than 2.8V and less than 10V.

**CHRG (Pin K7):** Open-Collector Charger Status Output; typically pulled up through a resistor to a reference voltage. This status pin can be pulled up to voltages as high as  $V_{\text{IN}}$  and can sink currents up to 10mA. During a battery charging cycle, CHRG is pulled low. When the charge current falls below  $C/10$ ,

## PIN FUNCTIONS

the  $\overline{\text{CHRG}}$  pin becomes high impedance. If the internal timer is used for termination, the pin stays low during the charging cycle until the charge current drops below a C/10 rate, approximately 200mA, even though the charger will continue to top off the battery until the end-of-charge timer terminates the charge cycle. A temperature fault also causes this pin to be pulled low (see the Applications Information section).

**NTC (Pin H6):** Battery Temperature Monitor Pin. This pin is the input to the NTC (negative temperature coefficient) thermistor temperature monitoring circuit. This function is enabled by connecting a 10k $\Omega$ , B = 3380 NTC thermistor from the NTC pin to ground. The pin sources 50 $\mu$ A, and monitors the voltage across the 10k $\Omega$  thermistor. When the voltage on this pin is above 1.36V ( $T < 0^\circ\text{C}$ ) or below 0.29V ( $T > 40^\circ\text{C}$ ), charging is disabled and the  $\overline{\text{CHRG}}$  and  $\overline{\text{FAULT}}$  pins are both pulled low. If the internal timer termination is being used, the timer is paused, suspending the charging cycle. Charging resumes when the voltage on NTC returns to within the 0.29V to 1.36V active region. There is approximately 5 $^\circ\text{C}$  of temperature hysteresis associated with each of the temperature thresholds. The temperature monitoring function remains enabled while thermistor resistance to ground is less than 250k $\Omega$ . If this function is not desired, leave the NTC pin unconnected.

**ADJ (Pin H7):** Battery Float Voltage Feedback Input. The charge function operates to achieve a final float voltage of 3.3V on this pin. The output battery float voltage ( $V_{\text{BAT(FLT)}}$ ) is programmed using a resistor divider.  $V_{\text{BAT(FLT)}}$  can be programmed up to 14.4V. The auto-restart feature initiates a new charging cycle when the voltage at the ADJ pin falls 2.5% below the float voltage reference. The ADJ pin input bias current is 110nA. Using a resistor divider with an equivalent input resistance at the ADJ pin of 250k compensates for input bias current error. Required resistor values to program desired  $V_{\text{BAT(FLT)}}$  follow the equations:

$$R1 = \frac{V_{\text{BAT(FLT)}} \cdot 2.5 \cdot 10^5}{3.3} (\Omega)$$

$$R2 = \frac{R1 \cdot 2.5 \cdot 10^5}{R1 - (2.5 \cdot 10^5)} (\Omega)$$

R1 is connected from BAT to ADJ, and R2 is connected from ADJ to ground.

**FAULT (Pin J7):** Open-Collector Fault Status Output; typically pulled up through a resistor to a reference voltage. This status

pin can be pulled up to voltages as high as  $V_{\text{IN}}$  and can sink currents up to 10mA. This pin indicates charge cycle fault conditions during a battery charging cycle. A temperature fault causes this pin to be pulled low. If the internal timer is used for termination, a bad battery fault also causes this pin to be pulled low. If no fault conditions exist, the  $\overline{\text{FAULT}}$  pin remains high impedance (see the Applications Information section).

**TMR (Pin J6):** End-Of-Cycle Timer Programming Pin. If a timer-based charge termination is desired, connect a capacitor from this pin to ground. Full charge end-of cycle time (in hours) is programmed with this capacitor following the equation:

$$t_{\text{EOC}} = C_{\text{TIMER}} \cdot 4.4 \cdot 10^6$$

A bad battery fault is generated if the battery does not reach the precondition threshold voltage within one-eighth of  $t_{\text{EOC}}$ , or:

$$t_{\text{PRE}} = C_{\text{TIMER}} \cdot 5.5 \cdot 10^5$$

A 0.68 $\mu$ F capacitor is often used, which generates a timer EOC at three hours, and a precondition limit time of 22.5 minutes. If a timer-based termination is not desired, the timer function can be disabled by connecting the TMR pin to ground. With the timer function disabled, charging terminates when the charge current drops below a C/10 rate, approximately 200mA.

**$V_{\text{INREG}}$  (Pin L6):** Input Voltage Regulation Reference. The maximum charge current is reduced when this pin is below 2.7V. Connecting a resistor divider from  $V_{\text{IN}}$  to this sets the minimum operational  $V_{\text{IN}}$  voltage. This is typically used to program the peak power voltage for a solar panel. The LTM8062 servos the maximum charge current required to maintain the programmed operational  $V_{\text{IN}}$  voltage, through maintaining the voltage on  $V_{\text{INREG}}$  at or above 2.7V. If the voltage regulation feature is not used, connect the pin to  $V_{\text{IN}}$ .

**RUN (Pin K6):** Precision Threshold Enable Input Pin. The RUN threshold is 1.25V (rising), with 120mV of input hysteresis. When in shutdown mode, all charging functions are disabled. The precision threshold allows use of the RUN pin to incorporate UVLO functions. If the RUN pin is pulled below 0.4V, the IC enters a low current shutdown mode where the  $V_{\text{IN}}$  pin current is reduced to 15 $\mu$ A. Typical RUN pin input bias current is 10nA. If the shutdown function is not desired, connect the pin to the  $V_{\text{IN}}$  pin.

## BLOCK DIAGRAM

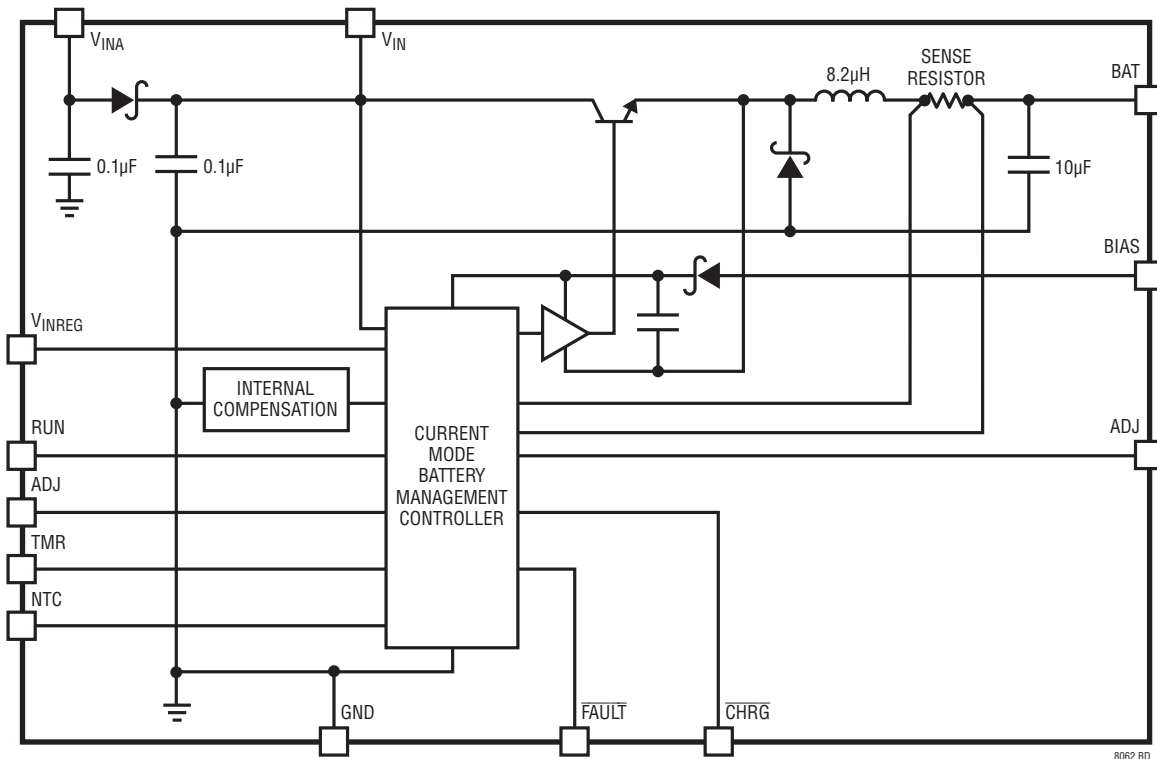

8062 BD

## OPERATION

The LTM8062 is a complete monolithic, mid-power, power tracking battery charger, addressing high input voltage applications with solutions that use a minimum of external components. The product can be programmed for float voltages between 3.3V and 14.4V with just two external resistors, operating under a 1MHz fixed frequency, average current mode step-down architecture. A 2A power Schottky diode is integrated within the  $\mu$ Module for reverse input voltage protection. A wide input range allows the operation to full charge from an input voltage up to 32V. A precision threshold on the RUN pin allows the implementation of a UVLO feature by using a simple resistor network. The charger can also be put into a low current shutdown mode, in which the input supply bias is reduced to only 15µA.

The LTM8062 employs an input voltage regulation loop, which reduces charge current if a monitored input voltage falls below a programmed level. When the LTM8062 is powered by a solar panel, the input regulation loop

is used to maintain the panel at peak output power. The LTM8062 automatically enters a battery precondition mode if the sensed battery voltage is very low. In this mode, the charge current is reduced to 300mA. Once the battery voltage climbs above the internally set precondition threshold (2.3V at the ADJ pin), the  $\mu$ Module automatically increases the maximum charge current to the full programmed value.

The LTM8062 can use a charge current based C/10 termination scheme, which ends a charge cycle when the battery charge current falls to one-tenth the programmed charge current. The LTM8062 also contains an internal charge cycle control timer, for timer-based termination. When using the internal timer, the charge cycle can continue beyond the C/10 level to top-off the battery. The charge cycle terminates when the programmed time elapses, about three hours for a 0.68µF timer capacitor. The  $\overline{\text{CHRG}}$  status pin continues to signal charging at a C/10 or greater rate, regardless of

8062f



## OPERATION

which termination scheme is used. When the timer-based scheme is used, the LTM8062 also supports bad battery detection, which triggers a system fault if a battery stays in precondition mode for more than one-eighth of the total programmed charge cycle time.

Once charging terminates and the LTM8062 is not actively charging, the charger automatically enters a low current standby mode in which supply bias currents are reduced to 85µA. If the battery voltage drops 2.5% from the full charge float voltage, the LTM8062 engages an automatic charge cycle restart. The IC also automatically restarts a new charge cycle after a bad-battery fault once the failed

battery is removed and replaced with another battery. The LTM8062 contains a battery temperature monitoring circuit. This feature, using a thermistor, monitors battery temperature and will not allow charging to begin, or will suspend charging, and signal a fault condition if the battery temperature is outside a safe charging range. The LTM8062 contains two digital open-collector outputs,  $\overline{\text{CHRG}}$  and  $\overline{\text{FAULT}}$ , which provide charger status and signal fault conditions. These binary coded pins signal battery charging, standby or shutdown modes, battery temperature faults and bad battery faults. For reference, C/10 and TMR based charging cycles are shown in Figures 1 and 2.

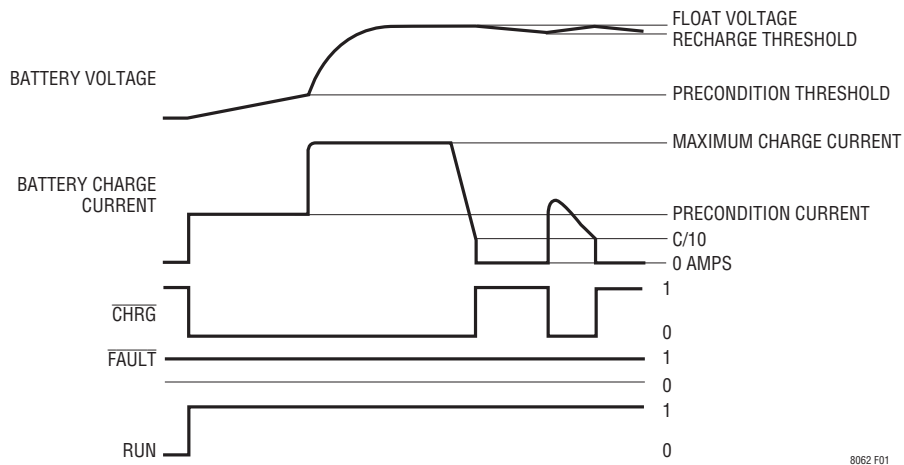

Figure 1. Typical C/10 Terminated Charge Cycle (TMR Grounded, Time Not to Scale)

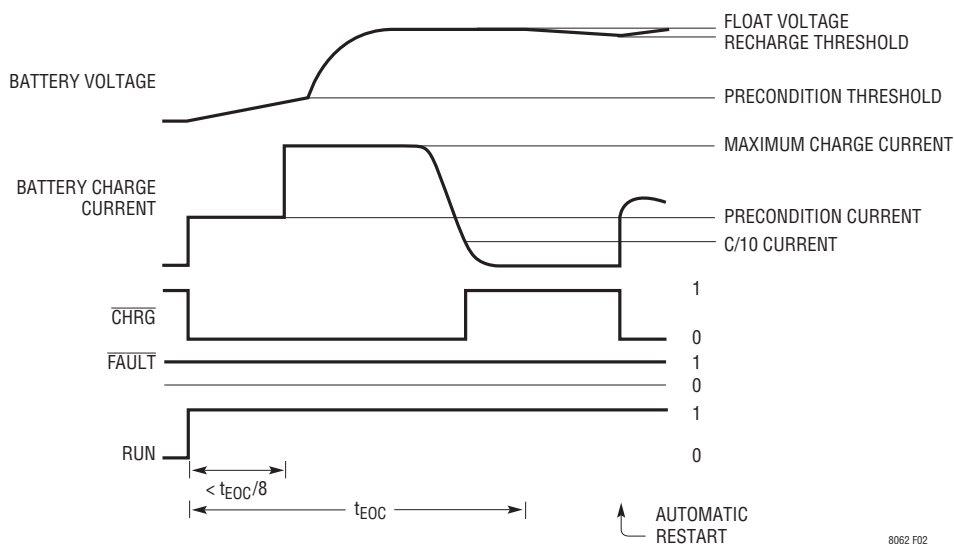

Figure 2. Typical EOC (Timer-Based) Terminated Charge Cycle (Capacitor Connected to TMR, Time Not to Scale)

## APPLICATIONS INFORMATION

For most applications, the design process is straight forward, summarized as follows:

1. Look at Table 1 and find the row that has the desired input voltage range and battery float voltage.
2. Apply the recommended  $C_{IN}$  and  $R_{ADJ}$  values.
3. Connect BIAS as indicated.

While these component combinations have been tested for proper operation, it is incumbent upon the user to verify proper operation over the intended system's line, load and environmental conditions. Bear in mind that the maximum output current is limited by junction temperature, the relationship between the input and output voltage magnitude and polarity and other factors. Please refer to the graphs in the Typical Performance Characteristics section for guidance.

**Table 1. Recommended Component Values and Configuration**  
( $T_A = 25^\circ\text{C}$ )

$V_{IN}$ RANGE (V)*	$V_{BAT}$ (V)	$C_{IN}$	$R_{ADJ1}$ TOP (k $\Omega$ )	$R_{ADJ2}$ BOTTOM (k $\Omega$ )
6 to 32	3.6	4.7 $\mu\text{F}$ 1206 X7R 50V	274	2870
6 to 32	4.1	4.7 $\mu\text{F}$ 1206 X7R 50V	312	1260
6 to 32	4.2	4.7 $\mu\text{F}$ 1206 X7R 50V	320	1150
6.25 to 32	4.7	4.7 $\mu\text{F}$ 1206 X7R 50V	357	835
9.5 to 32	7.05	4.7 $\mu\text{F}$ 1206 X7R 50V	530	464
9.75 to 32	7.2	4.7 $\mu\text{F}$ 1206 X7R 50V	549	459
11 to 32	8.2	4.7 $\mu\text{F}$ 1206 X7R 50V	626	417
11.5 to 32	8.4	4.7 $\mu\text{F}$ 1206 X7R 50V	642	412
12.75 to 32	9.4	4.7 $\mu\text{F}$ 1206 X7R 50V	715	383
16.5 to 32	12.3	4.7 $\mu\text{F}$ 1206 X7R 50V	942	344
17 to 32	12.6	4.7 $\mu\text{F}$ 1206 X7R 50V	965	340
18.25 to 32	13.5	4.7 $\mu\text{F}$ 1206 X7R 50V	1020	328
19 to 32	14.08	4.7 $\mu\text{F}$ 1206 X7R 50V	1090	332
19.5 to 32	14.42	4.7 $\mu\text{F}$ 1206 X7R 50V	1110	328

\* Input bulk capacitance is required.

### $V_{IN}$ Input Supply

The LTM8062 is biased directly from the charger input supply through the  $V_{IN}$  pin. This pin provides large switched currents, so a high quality low ESR decoupling capacitor is recommended to minimize voltage glitches on  $V_{IN}$ . 4.7 $\mu\text{F}$  is typically adequate for most charger applications.

### Reverse Protection Diode

The LTM8062 integrates a high voltage power Schottky diode to provide input reverse voltage protection. The anode of this diode is connected to  $V_{INA}$ , and the cathode is connected to  $V_{IN}$ . There is a small amount of capacitance at each end; please see the Block Diagram.

### Input Supply Voltage Regulation

The LTM8062 contains a voltage monitor pin that enables programming a minimum operational voltage. Connecting a resistor divider from  $V_{IN}$  to the  $V_{INREG}$  pin enables programming of minimum input supply voltage, typically used to program the peak power voltage for a solar panel. Maximum charge current is reduced when the  $V_{INREG}$  pin is below the regulation threshold of 2.7V.

If the  $V_{INREG}$  function is not used, and if the input supply cannot provide enough power to satisfy the requirements of an LTM8062 charger, the input supply voltage will collapse. A minimum operating supply voltage can thus be programmed by monitoring the supply through a resistor divider, such that the desired minimum voltage corresponds to 2.7V at the  $V_{INREG}$  pin. The LTM8062 servos the maximum output charge current to maintain the voltage on  $V_{INREG}$  at or above 2.7V.

Programming of the desired minimum voltage is accomplished by connecting a resistor divider as shown in Figure 3. The ratio of  $R_{IN1}/R_{IN2}$  for a desired minimum voltage ( $V_{IN(MIN)}$ ) is:

$$R_{IN1}/R_{IN2} = (V_{IN(MIN)}/2.7) - 1$$

If the voltage regulation feature is not used, connect the  $V_{INREG}$  pin to  $V_{IN}$ .

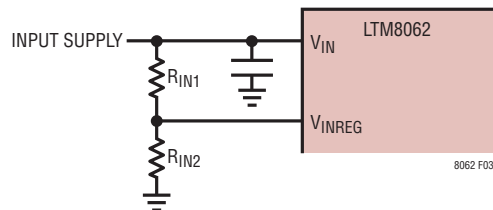

**Figure 3. Resistive Divider Sets Minimum  $V_{IN}$**

### BIAS Pin Considerations

The BIAS pin is used to provide drive power for the internal power switching stage and operate other internal

## APPLICATIONS INFORMATION

circuitry. For proper operation, it must be powered by at least 2.8V and no more than the absolute maximum rating of 10V. In most applications, connect BIAS to BAT. If there is no BIAS supply available or the battery voltage is below 2.8V, the internal switch requires more headroom from  $V_{IN}$  for proper operation. Please refer to the Typical Performance Characteristics curves for minimum start and running requirements under various battery conditions. When charging a 2-cell battery using a relatively high input voltage, the LTM8062 power dissipation can be reduced by connecting BIAS to a voltage between 2.8V and 3.3V.

### Output Capacitance

In many applications, the internal BAT capacitance of the LTM8062 is sufficient for proper operation. There are cases, however, where it may be necessary to add capacitance or otherwise modify the output impedance of the LTM8062. Case 1: the  $\mu$ Module is physically located far from the battery and the added line impedance may interfere with the control loop. Case 2: the battery ESR is very small or very large; the LTM8062 controller is designed for a wide range, but some battery packs have an ESR outside of this range. Case 3: there is no battery at all. As the charger is designed to work with the ESR of the battery, the output may oscillate if no battery is present.

The optimum ESR is about 100m $\Omega$ , but ESR values both higher and lower will work. Table 2 shows a sample of parts successfully tested by Linear Technology:

Table 2

PART NUMBER	DESCRIPTION	MANUFACTURER
16TQC22M	22 $\mu$ F, 16V, POSCAP	Sanyo
35SVPD18M	18 $\mu$ F, 35V, OS-CON	Sanyo
TPSD226M025R0100	22 $\mu$ F, 25V Tantalum	AVX
T495D226K025AS	22 $\mu$ F, 25V, Tantalum	Kemet
TPSC686M006R0150	68 $\mu$ F, 6V, Tantalum	AVX
TPSB476M006R0250	47 $\mu$ F, 6V, Tantalum	AVX
APXE100ARA680ME61G	68 $\mu$ F, 10V Aluminum	Nippon Chemicon
APS-150ELL680MHB5S	68 $\mu$ F, 25V Aluminum	Nippon Chemicon

If system constraints preclude the use of electrolytic capacitors, a series R-C network may be used. Use a ceramic capacitor of at least 22 $\mu$ F and an equivalent resistance of 100m $\Omega$ . An example of this is shown in the Typical Applications section.

### MPPT Temperature Compensation

A typical solar panel is comprised of a number of series-connected cells, each cell being a forward-biased p-n junction. As such, the open-circuit voltage ( $V_{OC}$ ) of a solar cell has a temperature coefficient that is similar to a common p-n diode, or about  $-2\text{mV}/^\circ\text{C}$ . The peak power point voltage ( $V_{MP}$ ) for a crystalline solar panel can be approximated as a fixed voltage below  $V_{OC}$ , so the temperature coefficient for the peak power point is similar to that of  $V_{OC}$ .

Panel manufacturers typically specify the 25 $^\circ\text{C}$  values for  $V_{OC}$ ,  $V_{MP}$ , and the temperature coefficient for  $V_{OC}$ , making determination of the temperature coefficient for  $V_{MP}$  of a typical panel straight forward. The LTM8062 employs a feedback network to program the  $V_{IN}$  input regulation voltage. Manipulation of the network makes for efficient implementation of various temperature compensation schemes for a maximum peak power tracking (MPPT) application. As the temperature characteristic for a typical solar panel  $V_{MP}$  voltage is highly linear, a simple solution for tracking that characteristic can be implemented using a Linear Technology LM234 3-terminal temperature sensor. This creates an easily programmable, linear temperature dependent characteristic.

In the circuit shown in Figure 4,

$$R_{IN1} = -R_{SET} \cdot (TC \cdot 4405), \text{ and}$$

$$R_{IN2} = \frac{R_{IN1}}{V_{MP}(25^\circ\text{C}) + R_{IN1} \cdot (0.0674 / R_{SET})} \cdot (V_{INREG} - 1)$$

where TC = temperature coefficient (in V/ $^\circ\text{C}$ ), and  $V_{MP}(25^\circ\text{C})$  = maximum power voltage at 25 $^\circ\text{C}$ .

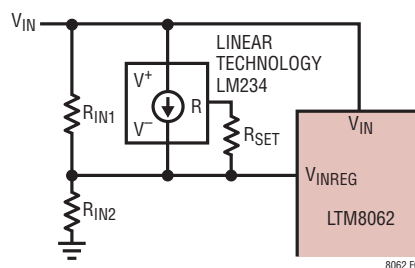

Figure 4. MPPT Temperature Compensation Network

## APPLICATIONS INFORMATION

For example, given a common 36-cell solar panel that has the following specified characteristics:

$$\text{Open Circuit Voltage (V}_{OC}) = 21.7\text{V}$$

$$\text{Maximum Power Voltage (V}_{MP}) = 17.6\text{V}$$

$$\text{Open-Circuit Voltage Temperature Coefficient (V}_{OC}) \\ = -78\text{mV}/^{\circ}\text{C}$$

As the temperature coefficient for  $V_{MP}$  is similar to that of  $V_{OC}$ , the specified temperature coefficient for  $V_{OC}$  (TC) of  $-78\text{mV}/^{\circ}\text{C}$  and the specified peak power voltage ( $V_{MP}(25^{\circ}\text{C})$ ) of  $17.6\text{V}$  can be inserted into the equations to calculate the appropriate resistor values for the temperature compensation network in Figure 4. With  $R_{SET}$  equal to  $1\text{k}$ , then:

$$R_{SET} = 1\text{k}$$

$$R_{IN1} = -1\text{k} \cdot (-0.078 \cdot 4405) = 344\text{k}$$

$$R_{IN2} = \frac{344\text{k}}{\frac{17.6 + 344\text{k} \cdot (0.0674 / 1\text{k})}{2.7} - 1} = 24.4\text{k}$$

### Battery Voltage Temperature Compensation

Some battery chemistries have charge voltage requirements that vary with temperature. Lead-acid batteries in particular experience a significant change in charge voltage requirements as temperature changes. For example, manufacturers of large lead-acid batteries recommend a float charge of  $2.25\text{V}/\text{cell}$  at  $25^{\circ}\text{C}$ . This battery float voltage, however, has a temperature coefficient which is typically specified at  $-3.3\text{mV}/^{\circ}\text{C}$  per cell.

In a manner similar to the MPPT temperature correction outlined previously, implementation of linear battery charge voltage temperature compensation can be accomplished by incorporating a Linear Technology LM234 into the output feedback network. For example, a 6-cell lead acid battery has a float charge voltage that is commonly specified at  $2.25\text{V}/\text{cell}$  at  $25^{\circ}\text{C}$ , or  $13.5\text{V}$ , and a  $-3.3\text{mV}/^{\circ}\text{C}$  per cell temperature coefficient, or  $-19.8\text{mV}/^{\circ}\text{C}$ . Using the feedback network shown in Figure 5, with the desired temperature coefficient (TC) and  $25^{\circ}\text{C}$  float voltage ( $V_{FLOAT}(25^{\circ}\text{C})$ ) specified, and using a convenient value of  $2.4\text{k}$  for  $R_{SET}$ , necessary resistor values follow the relations:

$$R_{FB1} = -R_{SET} \cdot (\text{TC} \cdot 4405) \\ = -2.4\text{k} \cdot (-0.0198 \cdot 4405) = 210\text{k}$$

$$R_{FB2} = \frac{R_{FB1}}{\frac{V_{FLOAT}(25^{\circ}\text{C}) + R_{FB1} \cdot (0.0674 / R_{SET})}{V_{FB}} - 1} \\ = \frac{210\text{k}}{\frac{13.5 + 210\text{k} \cdot (0.0674 / 2.4\text{k})}{3.3} - 1} \\ = 43\text{k}$$

$$R_{FB3} = 250\text{k} - R_{FB1} || R_{FB2} \\ = 250\text{k} - 210\text{k} || 43\text{k} = 215\text{k}$$

(see the Battery Float Voltage Programming section)

While the circuit in Figure 5 creates a linear temperature characteristic that follows a typical  $-3.3\text{mV}/^{\circ}\text{C}$  per cell lead-acid specification, the theoretical float charge

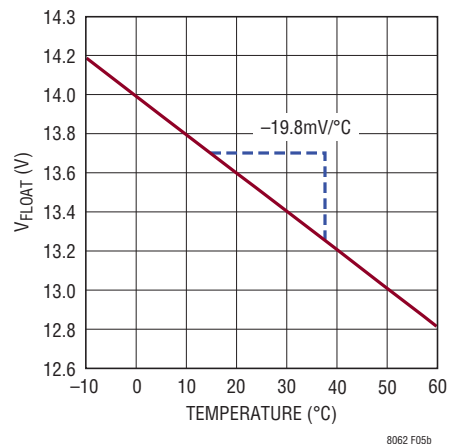
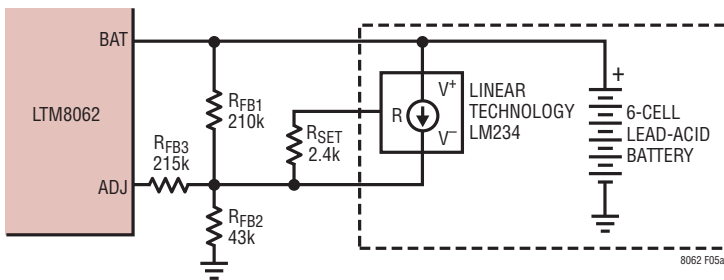
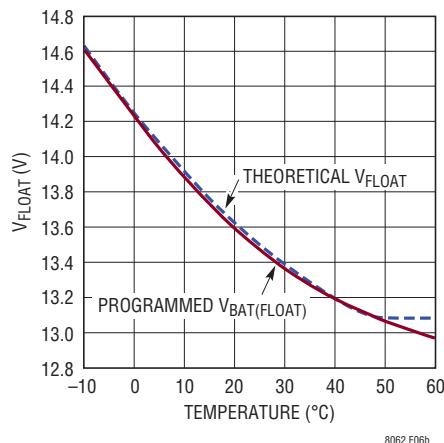
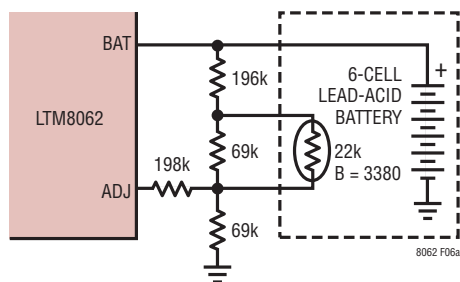

Figure 5. Lead-Acid 6-Cell Float Charge Voltage vs Temperature with a  $-19.8\text{mV}/^{\circ}\text{C}$  Temperature Coefficient Using LM234 with the Feedback Network

## APPLICATIONS INFORMATION



**Figure 6. Thermistor-Based Temperature Compensation Network Programs  $V_{\text{FLOAT}}$  to Closely Match Ideal Lead-Acid Float Charge Voltage for 6-Cell Charger**

voltage characteristic is slightly nonlinear. This nonlinear characteristic follows the relation:

$$V_{\text{FLOAT}} = 4 \cdot 10^{-5} (T^2) - 6 \cdot 10^{-3} (T) + 2.375$$

(with a 2.18V minimum)

where  $T$  = temperature in  $^{\circ}\text{C}$ . A thermistor-based network can be used to approximate the nonlinear ideal temperature characteristic across a reasonable operating range, as shown in Figure 6.

### Status Pins

The LTM8062 reports charger status through two open-collector outputs, the  $\overline{\text{CHRG}}$  and  $\overline{\text{FAULT}}$  pins. These pins can be pulled up as high as  $V_{\text{IN}}$ , and can sink up to 10mA. The  $\overline{\text{CHRG}}$  pin indicates that the charger is delivering current at greater than a C/10 rate, or one-tenth of the programmed charge current. The  $\overline{\text{FAULT}}$  pin signals bad-battery and NTC faults. These pins are binary coded, as shown in Table 3.

**Table 3. Status Pin State**

$\overline{\text{CHRG}}$	$\overline{\text{FAULT}}$	STATUS
High	High	Not Charging—Standby or Shutdown Mode
High	Low	Bad-Battery Fault (Precondition Timeout/EOC Failure)
Low	High	Normal Charging at C/10 or Greater
Low	Low	NTC Fault (Pause)

If the battery is removed from an LTM8062 charger that is configured for C/10 termination, a low amplitude sawtooth waveform appears at the charger output, due to cycling between termination and recharge events. This cycling

results in pulsing at the  $\overline{\text{CHRG}}$  output. An LED connected to this pin will exhibit a blinking pattern, indicating to the user that a battery is not present. The frequency of this blinking pattern is dependent on the output capacitance.

### C/10 Charge Termination

The LTM8062 supports a low current based termination scheme, where a battery charge cycle terminates when the charge current falls below one-tenth the programmed charge current, or approximately 200mA. This termination mode is engaged by shorting the TMR pin to ground. When C/10 termination is used, an LTM8062 charger sources battery charge current as long as the average current level remains above the C/10 threshold. As the full-charge float voltage is achieved, the charge current falls until the C/10 threshold is reached, at which time the charger terminates and the LTM8062 enters standby mode. The  $\overline{\text{CHRG}}$  status pin follows the charger cycle and is high impedance when the charger is not actively charging. There is no provision for bad-battery detection if C/10 termination is used.

### Timer Charge Termination

The LTM8062 supports a timer-based termination scheme, where a battery charge cycle terminates after a specific amount of time elapses. Timer termination is engaged when a capacitor ( $C_{\text{TIMER}}$ ) is connected from the TMR pin to ground. The timer cycle time span ( $t_{\text{EOC}}$ ) is determined by  $C_{\text{TIMER}}$  in the equation:

$$C_{\text{TIMER}} = t_{\text{EOC}} \cdot 2.27 \cdot 10^{-7} \text{ (Hours)}$$

## APPLICATIONS INFORMATION

When charging at a 1C rate,  $t_{EOC}$  is commonly set to three hours, which requires a 0.68 $\mu$ F capacitor.

The  $\overline{\text{CHRG}}$  status pin continues to signal charging, regardless of which termination scheme is used. When timer termination is used, the  $\overline{\text{CHRG}}$  status pin is pulled low during a charge cycle until the charge current falls below the C/10 threshold. The charger continues to top off the battery until timer EOC, when the LTM8062 terminates the charge cycle and enters standby mode.

Termination at the end of the timer cycle only occurs if the charge cycle was successful. A successful charge cycle occurs when the battery is charged to within 2.5% of the full-charge float voltage. If a charge cycle is not successful at EOC, the timer cycle resets and charging continues for another full timer cycle. When  $V_{\text{BAT}}$  drops 2.5% from the full-charge float voltage, whether by battery loading or replacement of the battery, the charger automatically resets and starts charging.

### Preconditioning and Bad-Battery Fault

The LTM8062 has a precondition mode, where the charge current is limited to 15% of the maximum charge current, or approximately 300mA. Precondition mode is engaged if the voltage on the BAT pin is below the precondition threshold, or approximately 70% of the float voltage. Once the BAT voltage rises above the precondition threshold, normal full-current charging can commence. The LTM8062 incorporates 90mV hysteresis to avoid spurious mode transitions.

Bad-battery detection is engaged when the internal timer is used for termination (capacitor tied to TMR). This fault detection feature is designed to identify failed cells. A bad-battery fault is triggered when the voltage on BAT remains below the precondition threshold for greater than one-eighth of a full timer cycle (one-eighth EOC). A bad-battery fault is also triggered if a normally charging battery re-enters precondition mode after one-eighth EOC.

When a bad-battery fault is triggered, the charge cycle is suspended, and the  $\overline{\text{CHRG}}$  status pin becomes high impedance. The  $\overline{\text{FAULT}}$  pin is pulled low to signal that a fault has been detected.

Cycling the charger's power or shutdown function initiates a new charge cycle, but the LTM8062 charger does not require a manual reset. Once a bad-battery fault is detected,

a new timer charge cycle initiates if the BAT pin exceeds the precondition threshold voltage. During a bad-battery fault, a small current is sourced from the charger; removing the failed battery allows the charger output voltage to rise above the preconditioning threshold voltage and initiate a charge cycle reset. A new charge cycle is started by connecting another battery to the charger output.

### Battery Temperature Fault: NTC

The LTM8062 can accommodate battery temperature monitoring by using an NTC (negative temperature coefficient) thermistor close to the battery pack. The temperature monitoring function is enabled by connecting a 10k $\Omega$ ,  $\beta \approx 3380$  NTC thermistor from the NTC pin to ground. If the NTC function is not desired, leave the pin open. The NTC pin sources 50 $\mu$ A, and monitors the voltage dropped across the 10k $\Omega$  thermistor. When the voltage on this pin is above 1.36V (0 $^{\circ}$ C) or below 0.29V (40 $^{\circ}$ C), the battery temperature is out of range, and the LTM8062 triggers an NTC fault. The NTC fault condition remains until the voltage on the NTC pin corresponds to a temperature within the 0 $^{\circ}$ C to 40 $^{\circ}$ C range. Both hot and cold thresholds incorporate 20% hysteresis, which equates to about 5 $^{\circ}$ C. If higher operational charging temperatures are desired, the temperature range can be expanded by adding series resistance to the 10k NTC resistor. Adding a 909 $\Omega$  resistor will increase the effective temperature threshold to 45 $^{\circ}$ C, for example.

During an NTC fault, charging is halted and both status pins are pulled low. If timer termination is enabled, the timer count is suspended and held until the fault condition is cleared.

### Thermal Foldback

The LTM8062 contains a thermal foldback protection feature that reduces charge current as the IC junction temperature approaches 125 $^{\circ}$ C. In most cases, on-chip temperatures servo such that any overtemperature conditions are relieved with only slight reductions in maximum charge current. In some cases, the thermal foldback protection feature can reduce charge currents below the C/10 threshold. In applications that use C/10 termination (TMR = 0V), the LTM8062 will suspend charging and enter standby mode until the overtemperature condition is relieved.

## APPLICATIONS INFORMATION

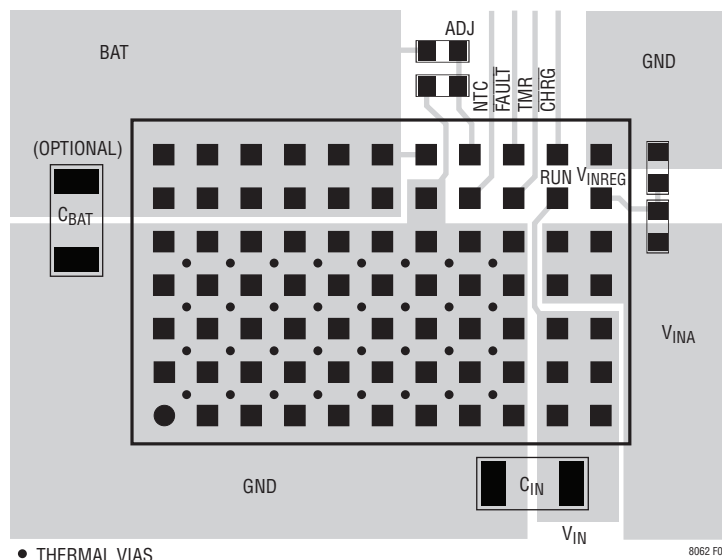

Figure 7. Suggested Layout and Via Placement

### PCB Layout

Most of the headaches associated with PCB layout have been alleviated or even eliminated by the high level of LTM8062 integration. The LTM8062 is nevertheless a switching power supply, and care must be taken to minimize EMI and ensure proper operation. Even with the high level of integration, you may fail to achieve specified operation with a haphazard or poor layout. See Figure 7 for a suggested layout. Ensure that the grounding and heat sinking are acceptable.

1. Place the  $C_{IN}$  capacitor as close as possible to the  $V_{IN}$  and GND connection of the LTM8062.
2. If used, place the  $C_{BAT}$  capacitor as close as possible to the BAT and GND connection of the LTM8062.
3. Place the  $C_{IN}$  and  $C_{BAT}$  (if used) capacitors such that their ground current flows directly adjacent or underneath the LTM8062.
4. Connect all of the GND connections to as large a copper pour or plane area as possible on the top layer. Avoid breaking the ground connection between the external components and the LTM8062.
5. For good heat sinking, use vias to connect the GND copper area to the board's internal ground planes. Liberally distribute these GND vias to provide both a good ground connection and thermal path to the internal planes of the

printed circuit board. Pay attention to the location and density of the thermal vias in Figure 5. The LTM8062 can benefit from the heat-sinking afforded by vias that connect to internal GND planes at these locations, due to their proximity to internal power handling components. The optimum number of thermal vias depends upon the printed circuit board design. For example, a board might use very small via holes. It should employ more thermal vias than a board that uses larger holes.

### Hot-Plugging Safely

The small size, robustness and low impedance of ceramic capacitors make them an attractive option for the input bypass capacitor of LTM8062. However, these capacitors can cause problems if the LTM8062 is plugged into a live input supply (see Application Note 88 for a complete discussion). The low loss ceramic capacitor combined with stray inductance in series with the power source forms an underdamped tank circuit, and the voltage at the  $V_{IN}$  pin of the LTM8062 can ring to more than twice the nominal input voltage, possibly exceeding the LTM8062's rating and damage the part. If the input supply is poorly controlled or the user will be plugging the LTM8062 into an energized supply, the input network should be designed to prevent this overshoot. This can be accomplished by installing a small resistor in series with  $V_{IN}$ , but the most popular method of controlling input voltage overshoot is

## APPLICATIONS INFORMATION

to add an electrolytic bulk capacitor to the  $V_{IN}$  net. This capacitor's relatively high equivalent series resistance damps the circuit and eliminates the voltage overshoot. The extra capacitor improves low frequency ripple filtering and can slightly improve the efficiency of the circuit, though it is physically large.

### Thermal Considerations

The thermal performance of the LTM8062 is given in the Typical Performance Characteristics section. These curves were generated by the LTM8062 mounted to a 58cm<sup>2</sup> 4-layer FR4 printed circuit board. Boards of other sizes and layer count can exhibit different thermal behavior, so it is incumbent upon the user to verify proper operation over the intended system's line, load and environmental operating conditions.

For increased accuracy and fidelity to the actual application, many designers use FEA to predict thermal performance. To that end, the Pin Configuration section of the data sheet typically gives four thermal coefficients:

1.  $\theta_{JA}$ : Thermal resistance from junction to ambient.
2.  $\theta_{JCbottom}$ : Thermal resistance from junction to the bottom of the product case.
3.  $\theta_{JCTop}$ : Thermal resistance from junction to top of the product case.
4.  $\theta_{JB}$ : Thermal resistance from junction to the printed circuit board.

While the meaning of each of these coefficients may seem to be intuitive, JEDEC has defined each to avoid confusion and inconsistency. These definitions are given in JESD 51-12, and are quoted or paraphrased below:

1.  $\theta_{JA}$  is the natural convection junction-to-ambient air thermal resistance measured in a one cubic foot sealed enclosure. This environment is sometimes referred to as "still air" although natural convection causes the air to move. This value is determined with the part mounted to a JESD 51-9 defined test board, which does not reflect an actual application or viable operating condition.
2.  $\theta_{JCbottom}$  is the junction-to-board thermal resistance with all of the component power dissipation flowing through the bottom of the package. In the typical  $\mu$ Module, the bulk of the heat flows out the bottom

of the package, but there is always heat flow out into the ambient environment. As a result, this thermal resistance value may be useful for comparing packages but the test conditions don't generally match the user's application.

3.  $\theta_{JCTop}$  is determined with nearly all of the component power dissipation flowing through the top of the package. As the electrical connections of the typical  $\mu$ Module are on the bottom of the package, it is rare for an application to operate such that most of the heat flows from the junction to the top of the part. As in the case of  $\theta_{JCbottom}$ , this value may be useful for comparing packages but the test conditions don't generally match the user's application.
4.  $\theta_{JB}$  is the junction-to-board thermal resistance where almost all of the heat flows through the bottom of the  $\mu$ Module and into the board, and is really the sum of the  $\theta_{JCbottom}$  and the thermal resistance of the bottom of the part through the solder joints and through a portion of the board. The board temperature is measured a specified distance from the package, using a two sided, two layer board. This board is described in JESD 51-9.

The most appropriate way to use the coefficients is when running a detailed thermal analysis, such as FEA, which considers all of the thermal resistances simultaneously. None of them can be individually used to accurately predict the thermal performance of the product, so it would be inappropriate to attempt to use any one coefficient to correlate to the junction temperature versus load graphs given in the LTM8033 data sheet.

A graphical representation of these thermal resistances is given in Figure 8.

The blue resistances are contained within the  $\mu$ Module, and the green are outside.

The die temperature of the LTM8062 must be lower than the maximum rating of 125°C, so care should be taken in the layout of the circuit to ensure good heat sinking of the LTM8062. The bulk of the heat flow out of the LTM8062 is through the bottom of the module and the LGA pads into the printed circuit board. Consequently a poor printed circuit board design can cause excessive heating, resulting in impaired performance or reliability. Please refer to the PCB Layout section for printed circuit board design suggestions.



## APPLICATIONS INFORMATION

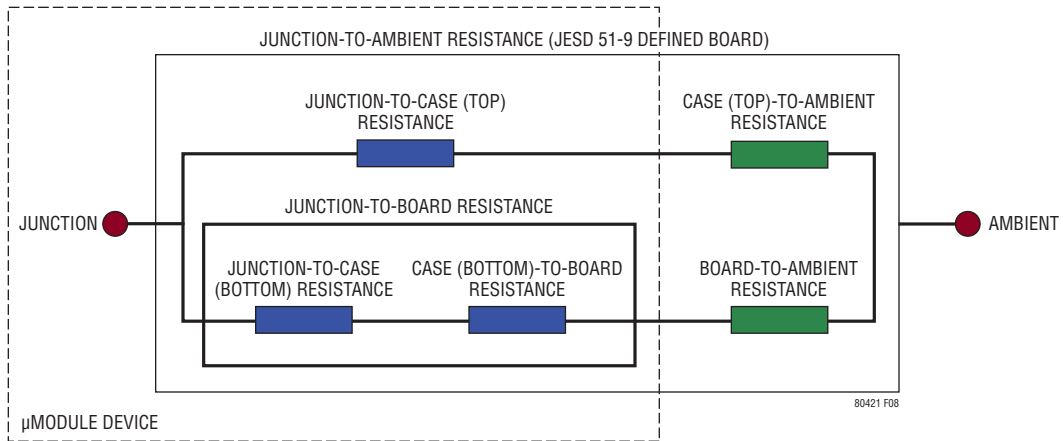
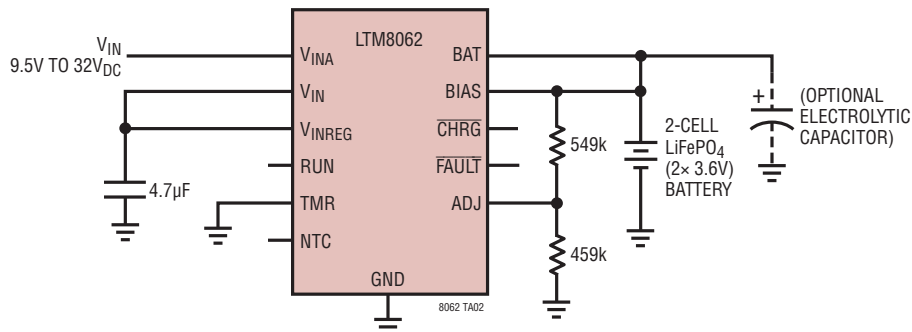

Figure 8. Thermal Resistances Among  $\mu$ Module Device Printed Circuit Board and Ambient Environment

## TYPICAL APPLICATIONS

### Basic 2A, 2-Cell LiFePO<sub>4</sub> Battery Charger with C/10 Termination



### 2A Solar Panel Power Manager with 8.4V Lithium Ion Battery Pack and 16V Peak Power Tracking

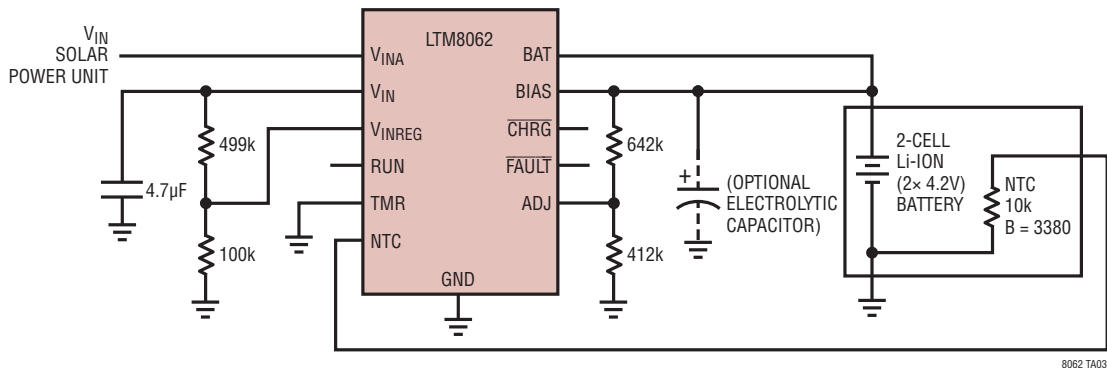

PACKAGE DESCRIPTION

**LGA Package**  
**77-Lead (15mm × 9mm × 4.32mm)**  
 (Reference LTC DWG # 05-08-1856 Rev A)

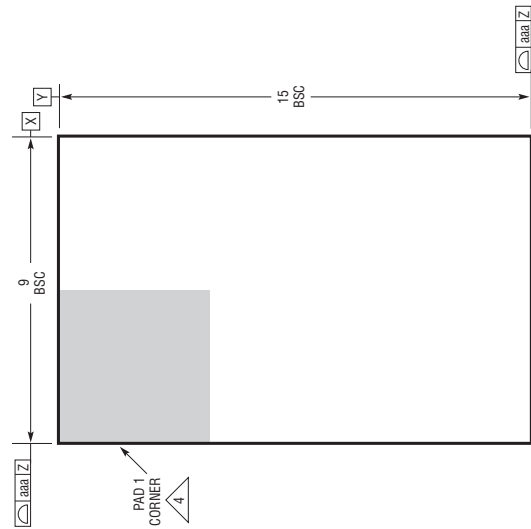
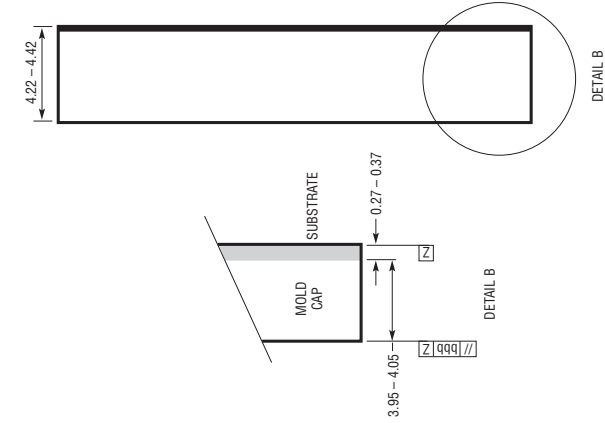
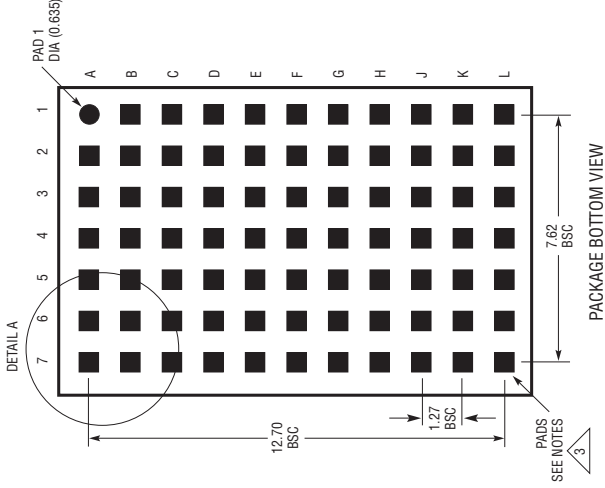

PACKAGE TOP VIEW

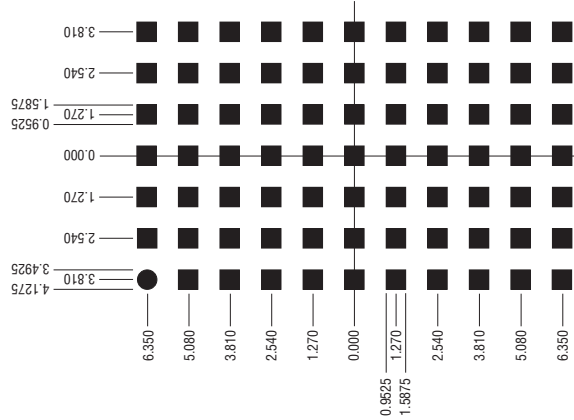

SUGGESTED PCB LAYOUT  
TOP VIEW

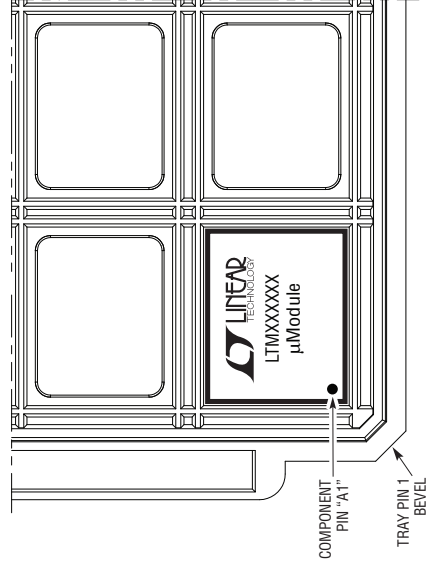

PACKAGE IN TRAY LOADING ORIENTATION

LGA 77 0609 REV A

- NOTES:
1. DIMENSIONING AND TOLERANCING PER ASME Y14.5M-1994
  2. ALL DIMENSIONS ARE IN MILLIMETERS
  3. LAND DESIGNATION PER JEDEC MO-222, SPP-010
  4. DETAILS OF PAD #1 IDENTIFIER ARE OPTIONAL, BUT MUST BE LOCATED WITHIN THE ZONE INDICATED. THE PAD #1 IDENTIFIER MAY BE EITHER A MOLD OR MARKED FEATURE
  5. PRIMARY DATUM -Z- IS SEATING PLANE
  6. THE TOTAL NUMBER OF PADS: 77

SYMBOL	TOLERANCE
aaa	0.15
bbb	0.10
eee	0.05

## PACKAGE DESCRIPTION

**Table 3. Pin Assignment Table  
(Arranged by Pin Number)**

PIN	NAME	PIN	NAME	PIN	NAME	PIN	NAME	PIN	NAME	PIN	NAME
A1	GND	B1	GND	C1	GND	D1	GND	E1	GND	F1	GND
A2	GND	B2	GND	C2	GND	D2	GND	E2	GND	F2	GND
A3	GND	B3	GND	C3	GND	D3	GND	E3	GND	F3	GND
A4	GND	B4	GND	C4	GND	D4	GND	E4	GND	F4	GND
A5	GND	B5	GND	C5	GND	D5	GND	E5	GND	F5	GND
A6	BAT	B6	BAT	C6	BAT	D6	BAT	E6	BAT	F6	BAT
A7	BAT	B7	BAT	C7	BAT	D7	BAT	E7	BAT	F7	BAT

PIN	NAME	PIN	NAME	PIN	NAME	PIN	NAME	PIN	NAME
G1	GND	H1	GND	J1	GND	K1	V <sub>IN</sub>	L1	V <sub>IN</sub>
G2	GND	H2	GND	J2	GND	K2	V <sub>IN</sub>	L2	V <sub>IN</sub>
G3	GND	H3	GND	J3	GND	K3	V <sub>IN</sub>	L3	V <sub>IN</sub>
G4	GND	H4	GND	J4	GND	K4	V <sub>INA</sub>	L4	V <sub>INA</sub>
G5	GND	H5	GND	J5	GND	K5	V <sub>INA</sub>	L5	V <sub>INA</sub>
G6	GND	H6	NTC	J6	TMR	K6	RUN	L6	V <sub>INREG</sub>
G7	BIAS	H7	ADJ	J7	FAULT	K7	CHRG	L7	GND

## PACKAGE PHOTO

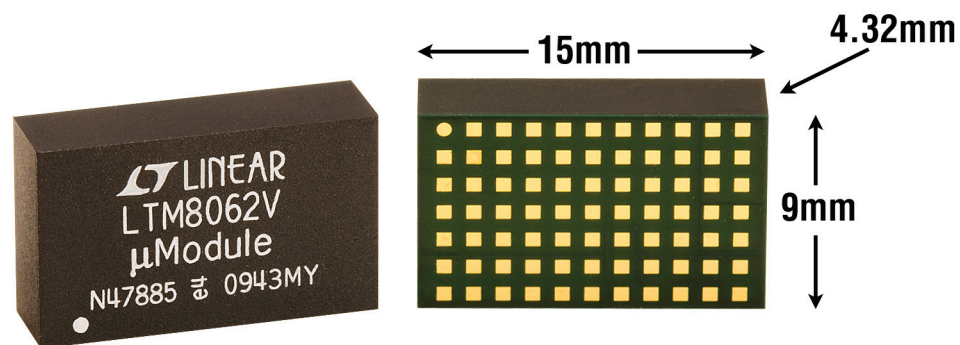

## TYPICAL APPLICATION

2A Solar Panel Power Manager for Charging 2-Cell 8.4V Lithium-Ion Battery, Featuring Three Hour Charge Time and 16V Peak Power Tracking. Battery Powers Two  $\mu$ Module Regulators

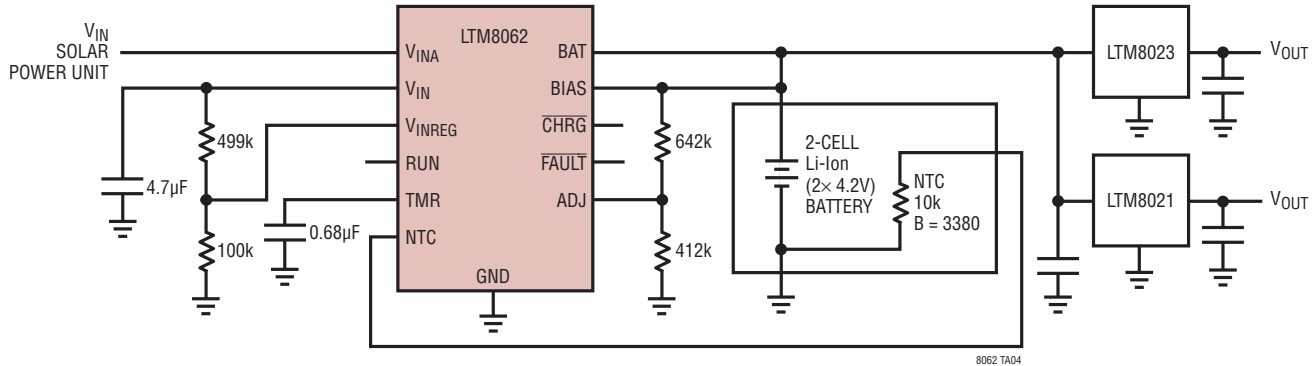

## RELATED PARTS

PART NUMBER	DESCRIPTION	COMMENTS
LTM4600	10A DC/DC $\mu$ Module Regulator	Basic 10A DC/DC $\mu$ Module, 15mm $\times$ 15mm $\times$ 2.8mm LGA
LTM4600HVMPV	Military Plastic 10A DC/DC $\mu$ Module Regulator	-55°C to 125°C Operation, 15mm $\times$ 15mm $\times$ 2.8mm LGA
LTM4601/ LTM4601A	12A DC/DC $\mu$ Module Regulator with PLL, Output Tracking/Margining and Remote Sensing	Synchronizable, PolyPhase Operation, LTM4601-1 Version has no Remote Sensing
LTM4602	6A DC/DC $\mu$ Module Regulator	Pin Compatible with the LTM4600
LTM4603	6A DC/DC $\mu$ Module Regulator with PLL and Output Tracking/Margining and Remote Sensing	Synchronizable, PolyPhase Operation, LTM4603-1 Version has no Remote Sensing, Pin Compatible with the LTM4601
LTM4604A	4A Low $V_{IN}$ DC/DC $\mu$ Module Regulator	$2.375V \leq V_{IN} \leq 5V$ , $0.8V \leq V_{OUT} \leq 5V$ , 9mm $\times$ 15mm $\times$ 2.3mm LGA
LTM4608A	8A Low $V_{IN}$ DC/DC $\mu$ Module Regulator	$2.375V \leq V_{IN} \leq 5V$ , $0.8V \leq V_{OUT} \leq 5V$ , 9mm $\times$ 15mm $\times$ 2.8mm LGA
LTM8020	200mA, 36V DC/DC $\mu$ Module Regulator	EN55022 Class B Compliant, Fixed 450kHz Frequency, $1.25V \leq V_{OUT} \leq 5V$ , 6.25mm $\times$ 6.25mm $\times$ 2.32mm LGA
LTM8022	1A, 36V DC/DC $\mu$ Module Regulator	Adjustable Frequency, $0.8V \leq V_{OUT} \leq 5V$ , 9mm $\times$ 11.25mm $\times$ 2.82mm LGA, Pin Compatible to the LTM8023
LTM8023	2A, 36V DC/DC $\mu$ Module Regulator	Adjustable Frequency, $0.8V \leq V_{OUT} \leq 5V$ , 9mm $\times$ 11.25mm $\times$ 2.82mm LGA, Pin Compatible to the LTM8022
LTM8025	3A, 36V DC/DC $\mu$ Module Regulator	$0.8V \leq V_{OUT} \leq 24V$ , 9mm $\times$ 15mm $\times$ 4.32mm LGA
LTM8021	500mA, 36V DC/DC $\mu$ Module Regulator	EN55022 Class B Compliant, Fixed 1.1MHz Frequency, $0.8V \leq V_{OUT} \leq 5V$ , 6.25mm $\times$ 11.25mm $\times$ 2.82mm LGA