

Triple Balanced Mixer

Model MM9xxN-1

Ultra-Broadband

RF 2.0 to 19.0 GHz

Electrical Specifications ⁽¹⁾:

Parameter	Conditions			Specifications			
	RF (GHz)	LO (GHz)	IF (GHz)	Min	Typical	Max	
SSB Conversion loss: ^{(2) (3)}	3.0-17.0	3.0-17.0	2.0-6.0		7.0 dB	9.5 dB	
	3.0-19.0	3.0-19.0	2.0-8.0		7.5 dB	11.0 dB	
	3.0-19.0	3.0-19.0	1.0-9.0		8.0 dB	12.5 dB	
	2.0-19.0	2.0-19.0	1.0-9.0		8.0 dB	13.5 dB	
Isolation LO to RF: LO to IF: RF to IF: IF to RF:	2.0-19.0	2.0-19.0		15 dB	24 dB		
		2.0-19.0		17 dB	30 dB		
			1.0-9.0		22 dB		
			1.0-9.0		25 dB		
Input 1 dB Compression Point:	2.0-19.0	2.0-19.0	1.0-9.0		+5 dBm +8 dBm +12 dBm +15 dBm	MM94 MM96 MM97 MM98	
Input Third Order Intercept Point:	2.0-19.0	2.0-19.0	1.0-9.0		+14 dBm +17 dBm +21 dBm +24 dBm	MM94 MM96 MM97 MM98	
LO Power: ⁽⁴⁾	2.0-19.0	2.0-19.0	1.0-9.0		+10 dBm +13 dBm +17 dBm +21 dBm	MM94 MM96 MM97 MM98	

Model MM9xxN-1

LO Power ←

4 = +10 dBm
6 = +13 dBm
7 = +17 dBm
8 = +21 dBm

Drop-In Module or With SMA(F) Connectors

M = Module
P = With Connectors

Notes:

- Specifications are guaranteed when tested as a downconverter in a 50 Ohm system from -55°C to +100°C with the nominal LO power. Specifications indicated as typical are not guaranteed.
- Noise figure is typically within ±0.5 dB of conversion loss.
- Conversion loss typically degrades less than 0.5 dB at +100°C and improves less than 0.5 dB at -55°C.
- Usable LO drives are up to 2 dB below and 3 dB above nominal.

Typical Performance at 25°C

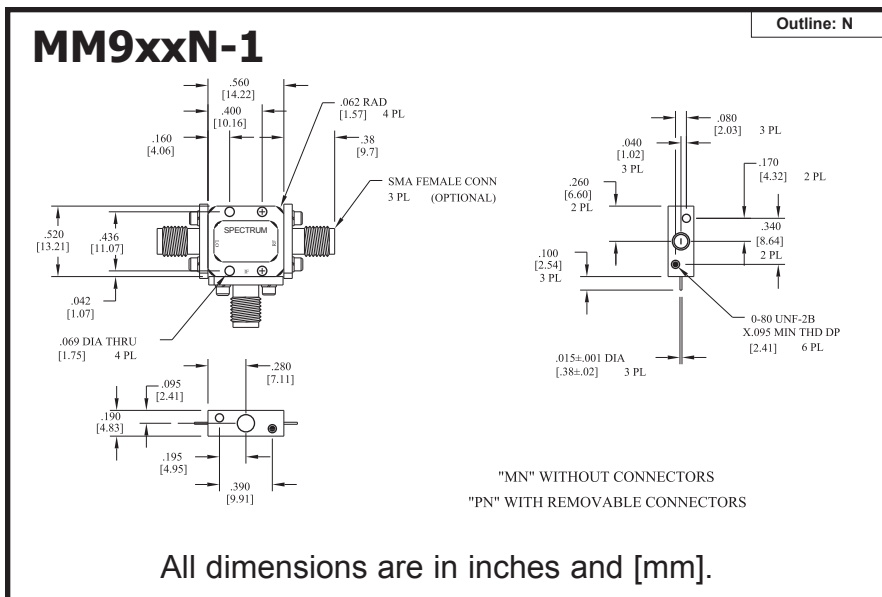
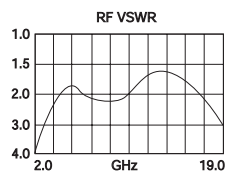
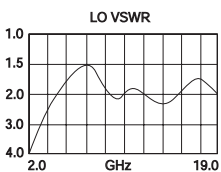
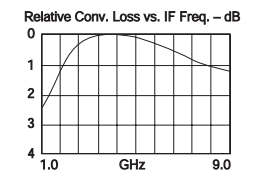
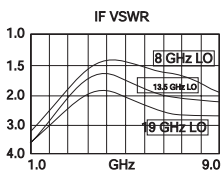
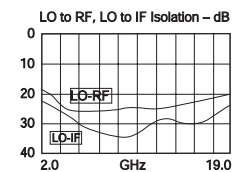
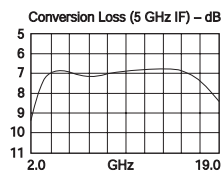
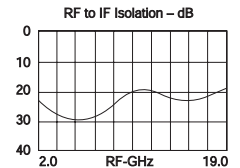

Spectrum Microwave · 2144 Franklin Drive N.E. · Palm Bay, FL 32905 · PH (888) 553-7531 · Fax (888) 553-7532

www.SpectrumMicrowave.com Spectrum Microwave (Europe) · 2707 Black Lake Place · Philadelphia, PA 19154 · PH (215) 464-4000 · Fax (215) 464-4001