

Typical Applications

The HMC925LC5 is ideal for:

- Point-to-Point and Point-to-Multi-Point Radio
- Military Radar, EW & ELINT
- Satellite Communications
- Sensors

Features

- High Conversion Gain: 16.5 dB
- Excellent Sideband Rejection: -30 dBc
- LO / RF Rejection: 22 dBc
- High Output IP3: +29 dBm
- 32 Lead 5x5 mm SMT Ceramic Package: 25 mm²

Functional Diagram

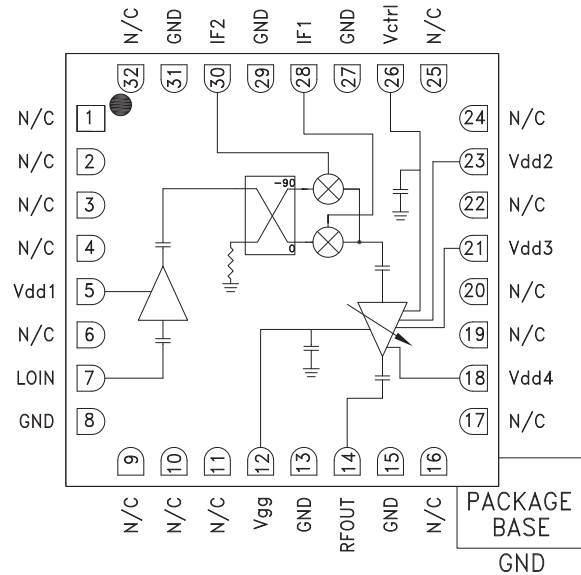

General Description

The HMC925LC5 is a compact GaAs MMIC I/Q upconverter in a leadless RoHS compliant SMT package. This device provides a small signal conversion gain of 16.5 dB with 30 dBc of sideband rejection. The HMC925LC5 utilizes a RF amplifier preceded by an I/Q mixer where the LO is driven by a driver amplifier. IF1 and IF2 mixer inputs are provided and an external 90° hybrid is needed to select the required sideband. The I/Q mixer topology reduces the need for filtering of the unwanted sideband. The HMC925LC5 is a much smaller alternative to hybrid style single sideband upconverter assemblies and it eliminates the need for wire bonding by allowing the use of surface mount manufacturing techniques.

Electrical Specifications ^{[1][2]}, T_A = +25°C, IF = 2000 MHz,

LO = +0 dBm, Vdd1, 2, 3, 4 = +5V, Idd2 + Idd3 + Idd4 = 130 mA LSB ^{[1][2]}, Idd1 = 114 mA

Parameter	Min.	Typ.	Max.	Units
Frequency Range, RF		5.5 - 8.6		GHz
Frequency Range, LO		5 - 11.1		GHz
Frequency Range, IF		0 - 3		GHz
Conversion Gain	14	16.5		dB
Sideband Rejection		-30		dBc
1 dB Compression (Output)		21		dBm
IP3 (Output)		29		dBm
LO / RF Rejection ^[3]		22		dBc
Supply Current Idd1		114		mA
Supply Current Idd2 + Idd3 + Idd4 ^[2]		130		mA

[1] Unless otherwise noted all measurements performed with high side LO, IF = 2000 MHz and external IF 90° hybrid.

[2] Adjust Vgg between -2 to 0V to achieve Idd2 + Idd3 + Idd4 = 130 mA Typical.

[3] The LO / RF Rejection is defined as the LO signal level at the RF output port relative to the desired RF output signal level.



Data Taken as SSB Upconverter with External IF 90° Hybrid, IF = 2000 MHz

Conversion Gain, LSB vs. Temperature

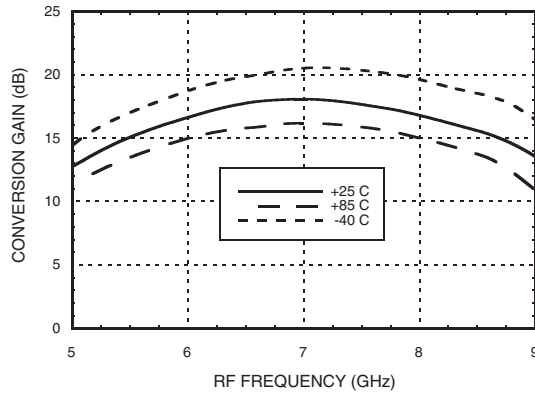

Conversion Gain, LSB vs. LO Drive

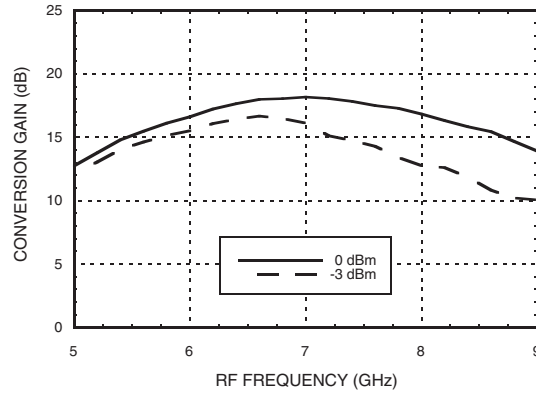

RF Return Loss vs. Temperature

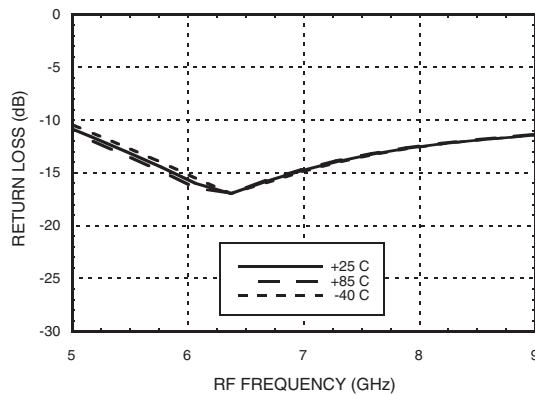

LO Return Loss vs. Temperature

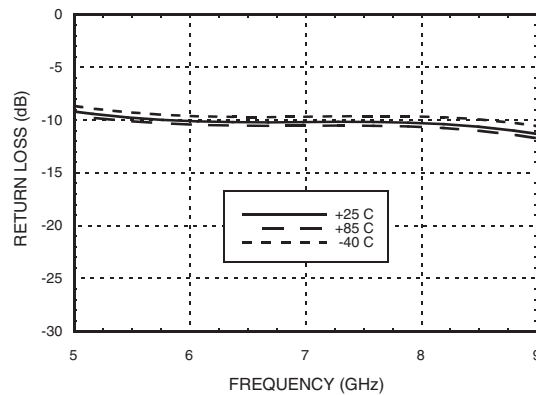

IF Return Loss [1]

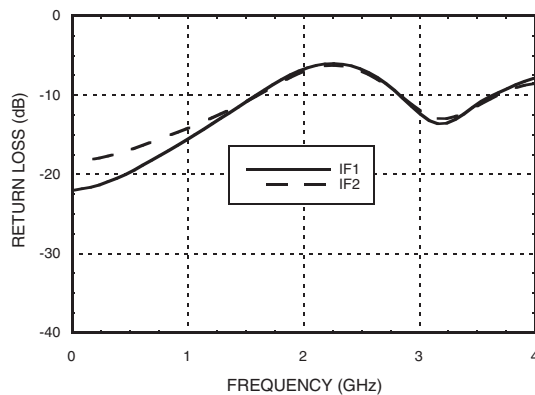

Sideband Rejection vs. Temperature

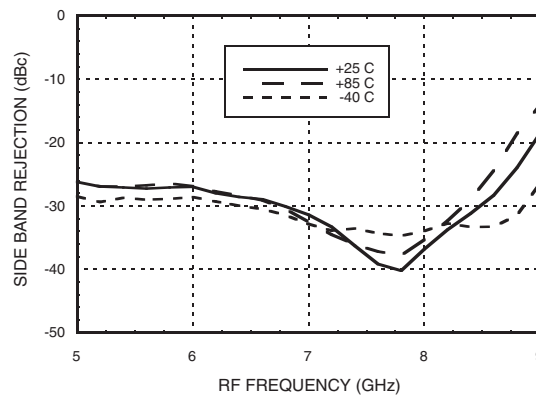

[1] Data taken without external IF 90° hybrid



Data Taken as SSB Upconverter with External IF 90° Hybrid, IF = 2000 MHz

Input P1dB, LSB vs. Temperature

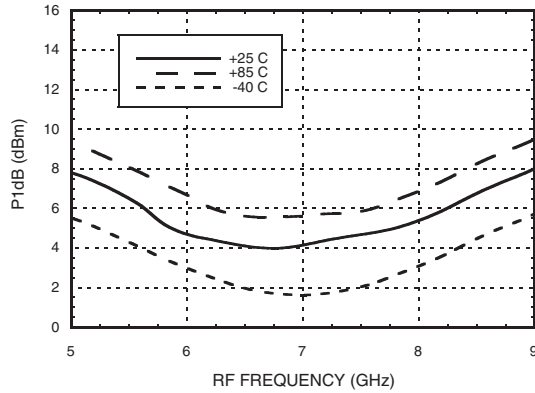

Output P1dB, LSB vs. Temperature

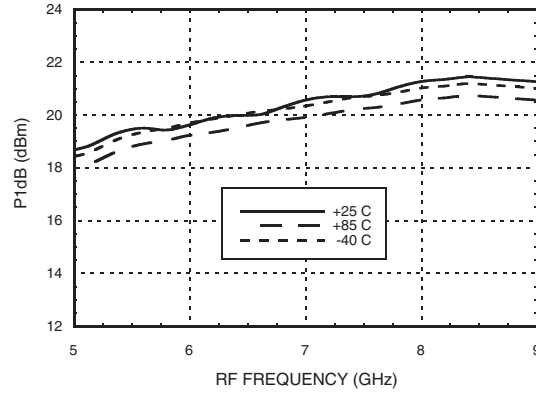

Input IP3, LSB vs. Temperature

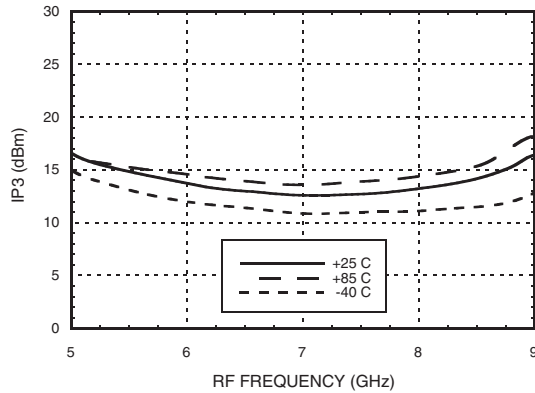

Output IP3, LSB vs. Temperature

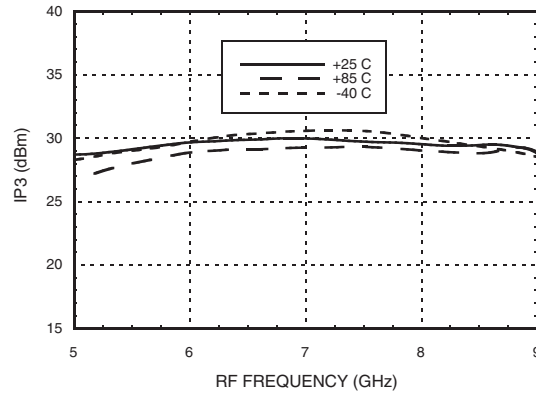

Conversion Gain, LSB vs. Control Voltage

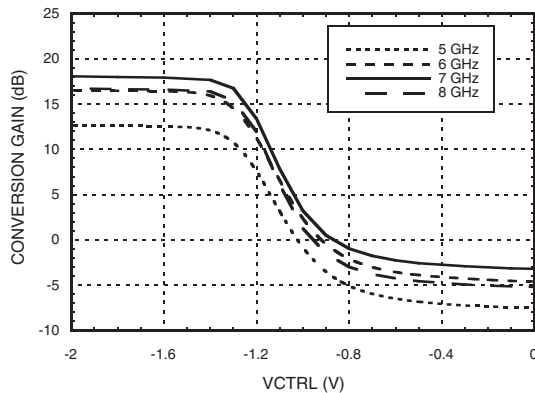

Input IP3, LSB vs. Control Voltage

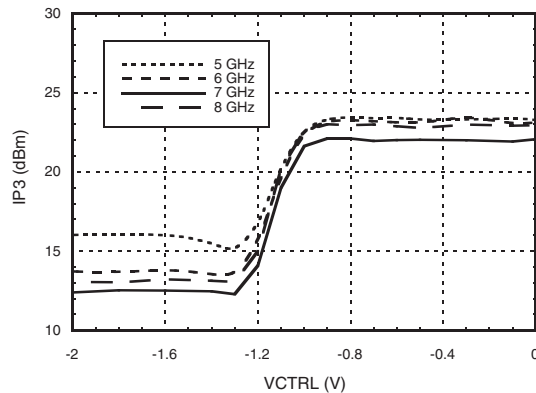

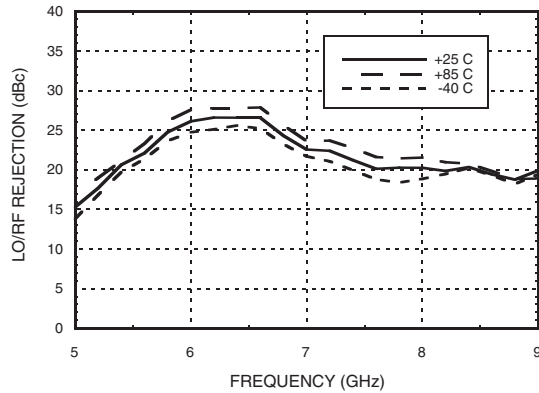
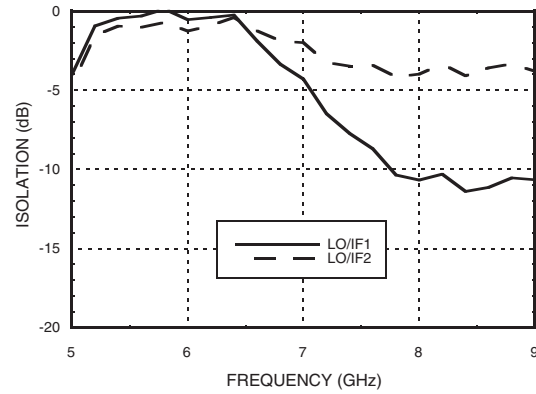

Data Taken as SSB Upconverter with External IF 90° Hybrid, IF = 2000 MHz

LO/RF Rejection, LSB

Isolation

[1] Data taken without external IF 90° hybrid

Data Taken as SSB Upconverter with External IF 90° Hybrid, IF = 3000 MHz

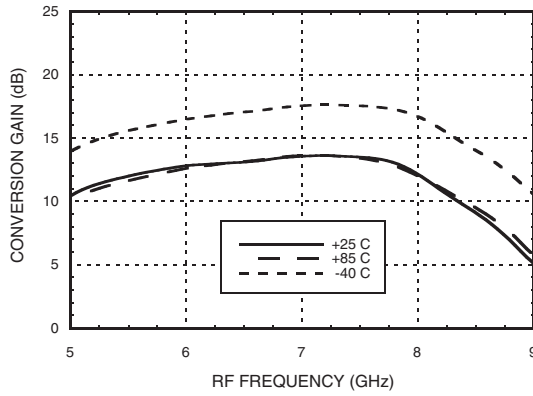
Conversion Gain, LSB vs. Temperature



Conversion Gain, LSB vs. LO Drive

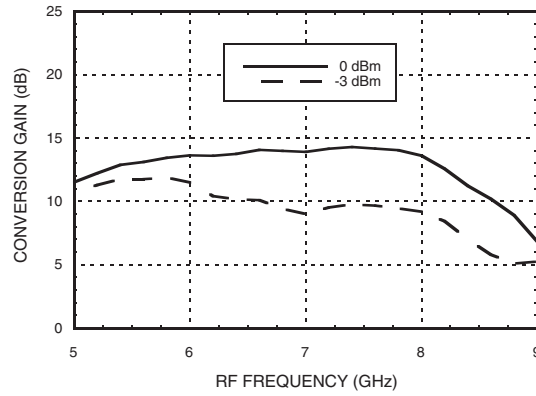

Sideband Rejection vs. Temperature

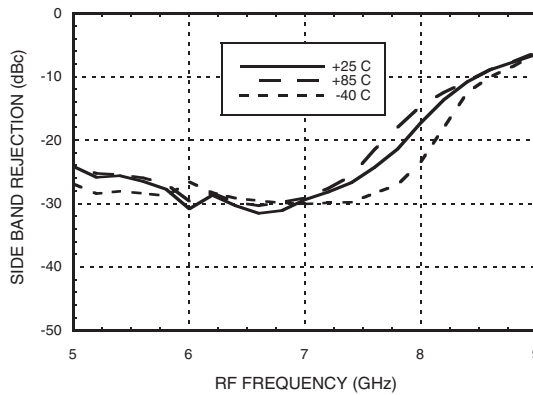

Input P1dB, LSB vs. Temperature

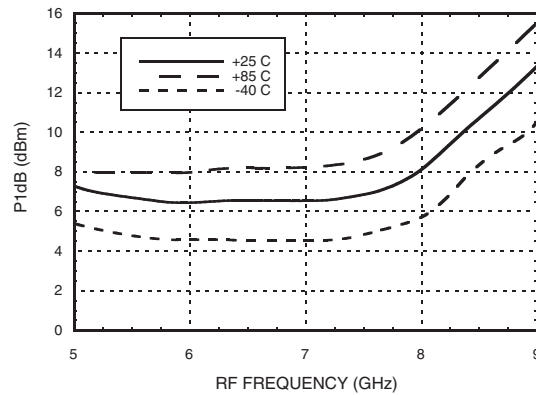

Output P1dB, LSB vs. Temperature

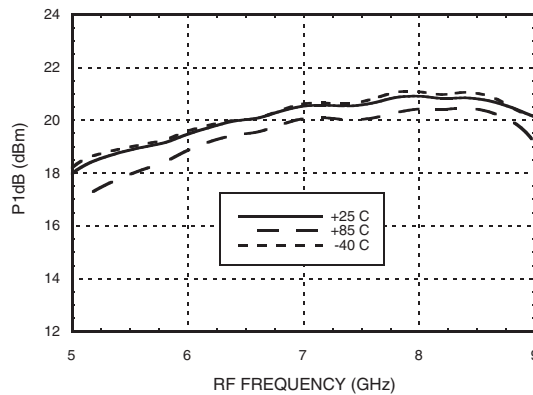

Input IP3, LSB vs. Temperature

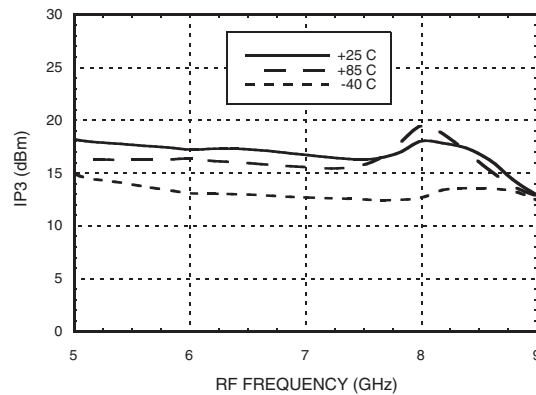



Data Taken as SSB Upconverter with External IF 90° Hybrid, IF = 3000 MHz

Output IP3, LSB vs. Temperature

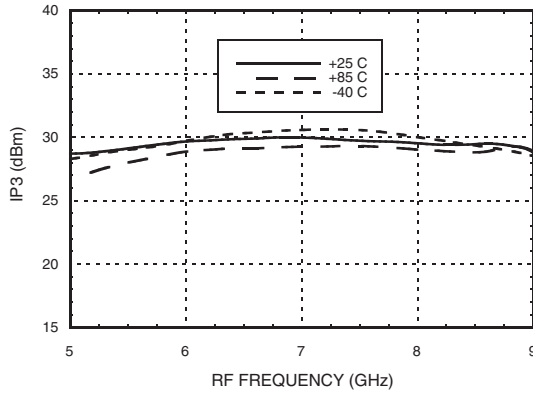

Conversion Gain, LSB vs. Control Voltage

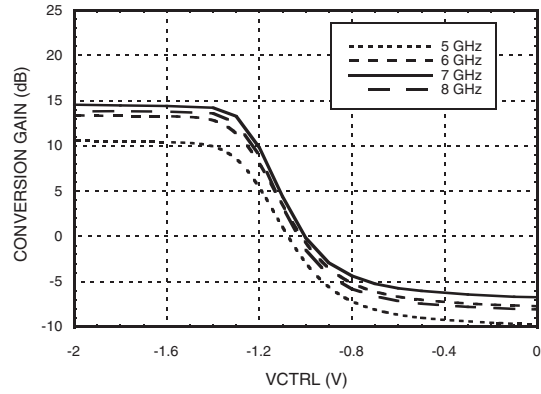

Input IP3, LSB vs. Control Voltage

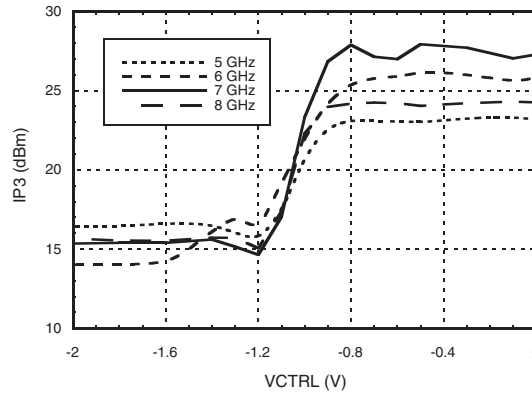

MxN Spurious Outputs [1][2]

mIF	nLO				
	0	1	2	3	4
0	x	-23.5	-24.1	-54.1	-60.1
-1	-70.1	0	-38.1	-42.1	-76.1
-2	-34.1	-56.1	-33.1	-65.1	-67.1
-3	69.1	-58.1	-84.1	-58.1	-85.1
-4	-69.1	-109.1	-74.1	-95.1	-74.1

IF = 2 GHz @ -6 dBm
LO = 8.5 GHz @ 0 dBm

MxN Spurious Outputs [1][2]

mIF	nLO				
	0	1	2	3	4
0	X	-16.4	-21.4	-55.4	-67.6
-1	-54.4	0	-34.4	-51.4	-73.4
-2	-36.4	-45.4	-37.44	-62.4	-71.4
-3	-73.1	-51.4	-68.4	-57.4	-83.4
-4	-85.4	-100.4	-82.4	-83.4	-82.4

IF = 2 GHz @ -6 dBm
LO = 10.1 GHz @ 0 dBm

[1] Data taken without external IF 90° hybrid
[2] All values in dBc below RF power level (LO - IF) ISB

Absolute Maximum Ratings

IF Input	+20 dBm
LO Input	+10 dBm
Channel Temperature	175 °C
Continuous Pdiss (T = 85°C) (derate 18.3 mW/°C above 85°C)	1.65 W
Thermal Resistance (channel to ground paddle)	54.6 °C/W
Storage Temperature	-65 to +150 °C
Operating Temperature	-40 to +85 °C



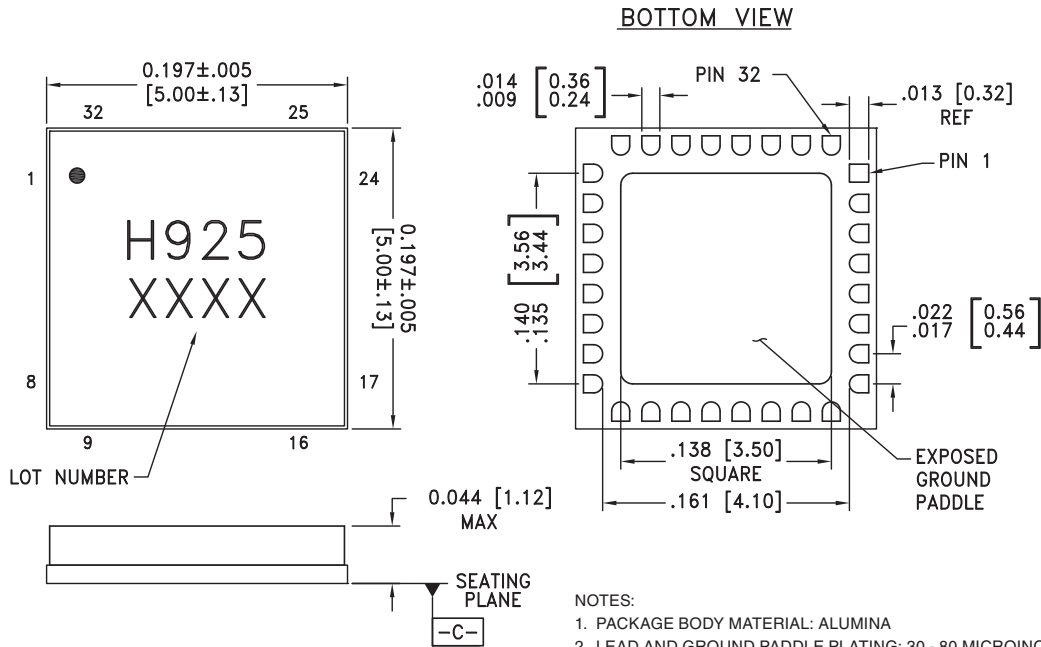

ELECTROSTATIC SENSITIVE DEVICE
OBSERVE HANDLING PRECAUTIONS

Outline Drawing

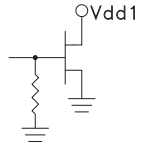
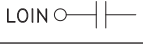

- NOTES:
1. PACKAGE BODY MATERIAL: ALUMINA
 2. LEAD AND GROUND PADDLE PLATING: 30 - 80 MICROINCHES GOLD OVER 50 MICROINCHES MINIMUM NICKLE
 3. DIMENSIONS ARE IN INCHES [MILLIMETERS]
 4. LEAD SPACING TOLERANCE IS NON-CUMULATIVE
 5. PACKAGE WARP SHALL NOT EXCEED 0.05mm DATUM
 6. ALL GROUND LEADS AND GROUND PADDLE MUST BE SOLDERED TO PCB RF GROUND

Pin Descriptions

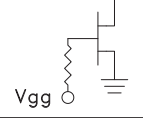
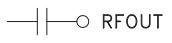
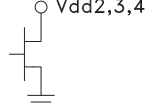
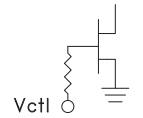
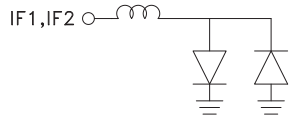
Pin Number	Function	Description	Interface Schematic
1 - 4, 6, 9 - 11, 16, 17, 19, 20, 22, 24, 25, 32	N/C	No connection required. The pins are not connected internally; however, all data shown herein was measured with these pins connected to RF/DC ground externally.	
5	Vdd1	Power supply voltage for LO amplifier. See application circuit for required external components.	
7	LOIN	This pin is AC coupled and matched to 50 Ohms.	
8, 13, 15, 27, 29, 31	GND	These pins and package bottom must be connected to RF/DC ground.	
12	Vgg	Gate control for RF amplifier, please follow "MMIC Amplifier Biasing Procedure" application note. See application circuit for required external components.	
14	RFOUT	This pin is AC coupled and matched to 50 Ohms.	
18, 21, 23	Vdd4, Vdd3, Vdd2	Power supply voltage for RF amplifier. See application circuit for required external components.	
26	Vctrl	Gain Control Voltage for RF Amplifier	
28	IF1	Differential IF input pins. For applications not requiring operation to DC, an off chip DC blocking capacitor should be used. For operation to DC this pin must not source/sink more than 3mA of current or part non function and possible part failure will result.	
30	IF2		



Typical Application

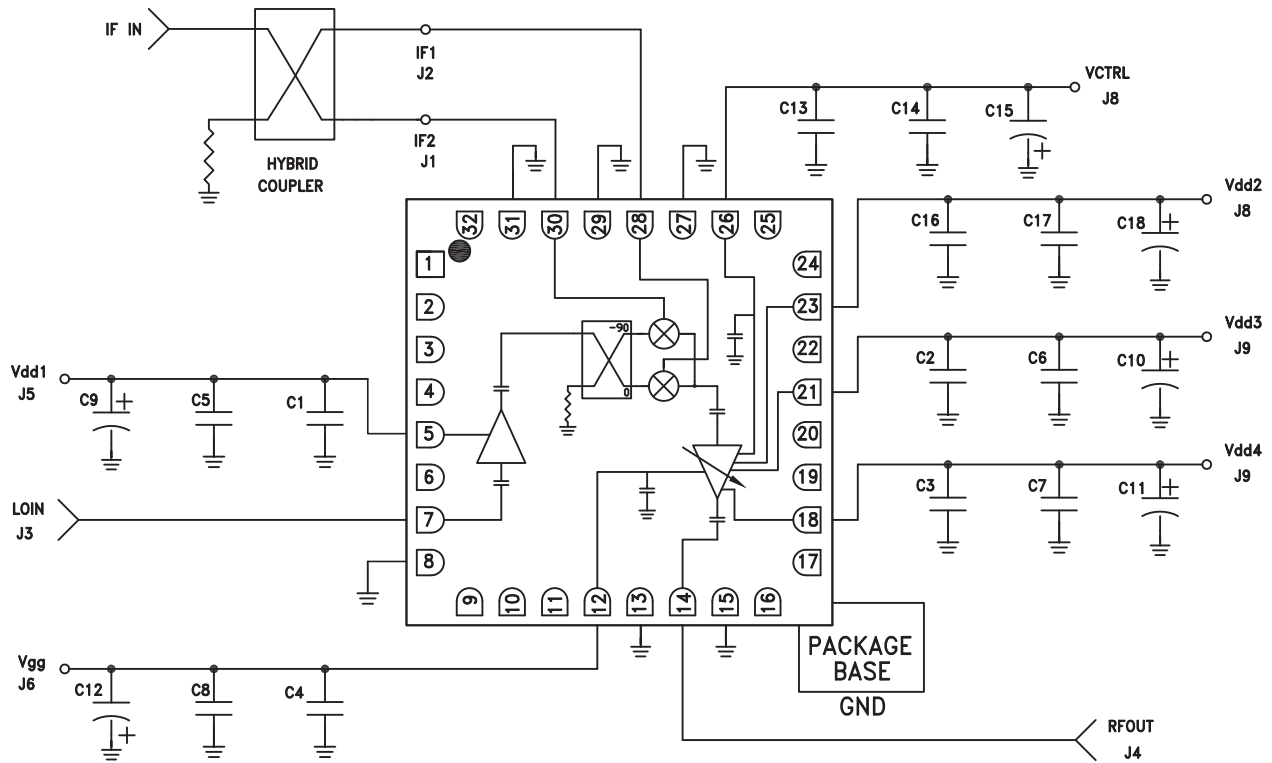

C1-C4, C13, C16	100 pF Capacitor, 0402 Pkg.
C5 - C8, C14, C17	1000 pF Capacitor, 0603 Pkg.
C9 - C12, C15, C18	2.2 μ F Capacitor, Case A Pkg.

Evaluation PCB

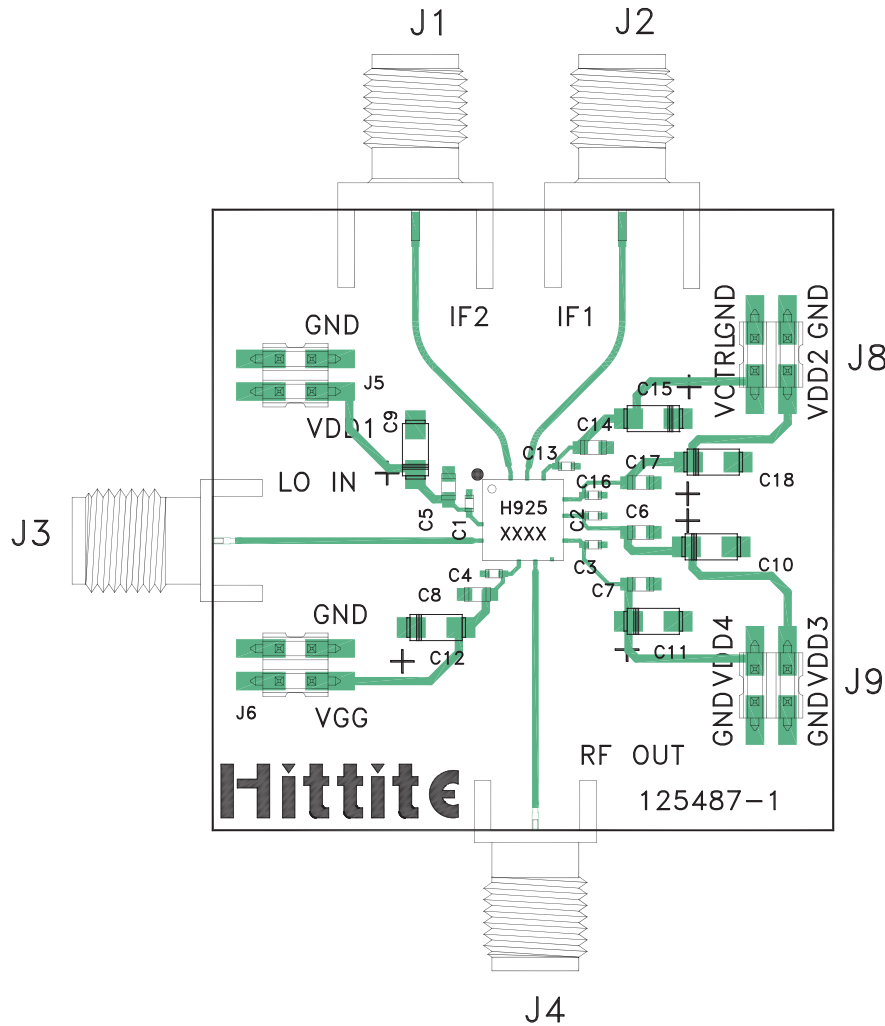

List of Materials for Evaluation PCB 131092 [1]

Item	Description
J1, J2	SMA Connector
J3, J4	K-Connector SRI
J5, J6, J8, J9	DC Pins
C1 - C4, C13, C16	100 pF Capacitor, 0402 Pkg.
C5 - C8, C14, C17	1000 pF Capacitor, 0603 Pkg.
C9 - C12, C15, C18	2.2 μF Capacitor, Case A
U1	HMC925LC5 Upconverter
PCB [2]	125487 Evaluation Board

[1] Reference this number when ordering complete evaluation PCB

[2] Circuit Board Material: Arlon 25FR, FR4 or Rogers 4350

The circuit board used in the application should use RF circuit design techniques. Signal lines should have 50 Ohm impedance while the package ground leads and exposed paddle should be connected directly to the ground plane similar to that shown. A sufficient number of via holes should be used to connect the top and bottom ground planes. The evaluation circuit board shown is available from Hittite upon request.