

### Features

- Dual USB port power switches
- Over-current and thermal protection
- 2.1A accurate current limiting
- Reverse Current Blocking
- 115mΩ on-resistance
- Input voltage range: 2.7V – 5.5V
- 0.6ms typical rise time
- Very low shutdown current: 1uA (max)
- Fault report (FLG) with blanking time (7ms typ)
- ESD protection: 4.5KV HBM, 350V MM
- Active high (AP2192) or active low (AP2182) enable
- Ambient temperature range: -40°C to 85°C
- SOP-8L and MSOP-8L-EP (Exposed Pad): Available in "Green" Molding Compound (No Br, Sb)
- Lead Free Finish / RoHS Compliant (Note 1)
- UL Recognized, File Number E322375
- IEC60950-1 CB Scheme Certified

### Description

The AP2182 and AP2192 are integrated high-side power switches optimized for Universal Serial Bus (USB) and other hot-swap applications. The family of devices complies with USB 2.0 and available with both polarities of Enable input. They offer current and thermal limiting and short circuit protection as well as controlled rise time and under-voltage lockout functionality. A 7ms deglitch capability on the open-drain Flag output prevents false over-current reporting and does not require any external components.

All devices are available in SOP-8L and MSOP-8L-EP packages.

### Applications

- Consumer electronics – LCD TV & Monitor, Game Machines
- Communications – Set-Top-Box, GPS, Smartphone
- Computing – Laptop, Desktop, Servers, Printers, Docking Station, HUB

### Ordering Information

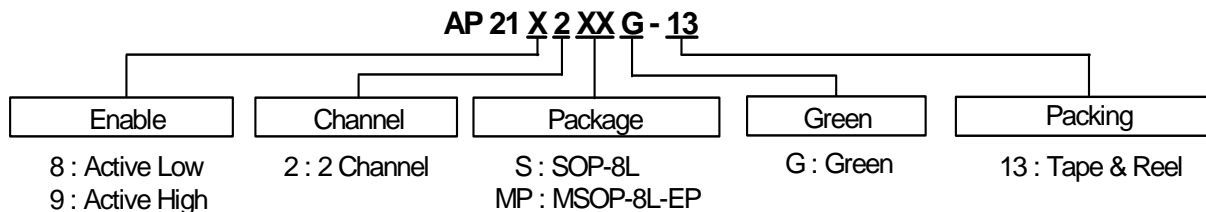

| Device       | Package Code | Packaging (Note 2) | 13" Tape and Reel |                    |
|--------------|--------------|--------------------|-------------------|--------------------|
|              |              |                    | Quantity          | Part Number Suffix |
| AP21X2SG-13  | S            | SOP-8L             | 2500/Tape & Reel  | -13                |
| AP21X2MPG-13 | MP           | MSOP-8L-EP         | 2500/Tape & Reel  | -13                |

- Notes:
1. EU Directive 2002/95/EC (RoHS). All applicable RoHS exemptions applied. Please visit our website at [http://www.diodes.com/products/lead\\_free.html](http://www.diodes.com/products/lead_free.html).
  2. Pad layout as shown on Diodes Inc. suggested pad layout document AP02001, which can be found on our website at <http://www.diodes.com/datasheets/ap02001.pdf>.

### Pin Assignment

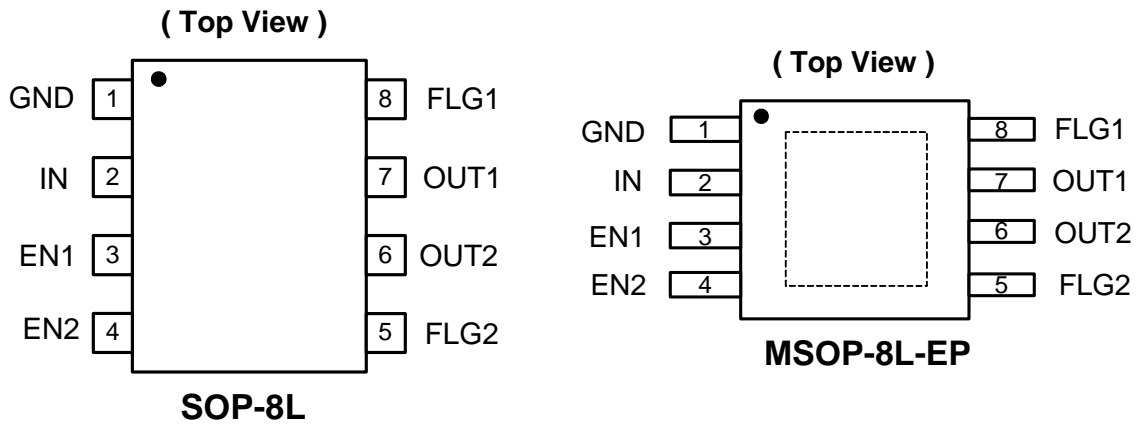

### Pin Descriptions

| Pin Name | Pin Number | Descriptions  |
|----------|------------|---|
| GND      | 1          | Ground  |
| IN       | 2          | Voltage input pin   |
| EN1      | 3          | Switch 1 enable input, active low (AP2182) or active high (AP2192)                                    |
| EN2      | 4          | Switch 2 enable input, active low (AP2182) or active high (AP2192)                                    |
| FLG2     | 5          | Switch 2 over-current and over-temperature fault report; open-drain flag is active low when triggered |
| OUT2     | 6          | Switch 2 voltage output pin   |
| OUT1     | 7          | Switch 1 voltage output pin   |
| FLG1     | 8          | Switch 1 over-current and over-temperature fault report; open-drain flag is active low when triggered |



### Absolute Maximum Ratings

| Symbol            | Parameter                          | Ratings          | Units |
|-------------------|------------------------------------|------------------|-------|
| ESD HBM           | Human Body Model ESD Protection    | 3                | KV    |
| ESD MM            | Machine Model ESD Protection       | 300              | V     |
| $V_{IN}$          | Input Voltage                      | 6.5              | V     |
| $V_{OUT}$         | Output Voltage                     | $V_{IN} + 0.3$   | V     |
| $V_{EN}, V_{FLG}$ | Enable Voltage                     | 6.5              | V     |
| $I_{load}$        | Maximum Continuous Load Current    | Internal Limited | A     |
| $T_{Jmax}$        | Maximum Junction Temperature       | 150              | °C    |
| $T_{ST}$          | Storage Temperature Range (Note 3) | -65 to 150       | °C    |

Notes: 3. UL Recognized Rating from -30°C to 70°C (Diodes qualified  $T_{ST}$  from -65°C to 150°C)

### Recommended Operating Conditions

| Symbol    | Parameter                     | Min | Max | Units |
|-----------|-------------------------------|-----|-----|-------|
| $V_{IN}$  | Input voltage                 | 2.7 | 5.5 | V     |
| $I_{OUT}$ | Output Current                | 0   | 1.5 | A     |
| $T_A$     | Operating Ambient Temperature | -40 | 85  | °C    |

### Electrical Characteristics

( $T_A = 25^\circ\text{C}$ ,  $V_{IN} = +5.0\text{V}$ , unless otherwise stated)

| Symbol        | Parameter                                 | Test Conditions  | Min  | Typ. | Max | Unit               |                  |
|---------------|---|--|--|------|-----|--------------------|------------------|
| $V_{UVLO}$    | Input UVLO                                | $R_{load} = 1\text{k}\Omega$   | 1.6  | 1.9  | 2.5 | V                  |                  |
| $I_{SHDN}$    | Input Shutdown Current                    | Disabled, $I_{OUT} = 0$  |  | 0.5  | 1   | $\mu\text{A}$      |                  |
| $I_Q$         | Input Quiescent Current, Dual             | Enabled, $I_{OUT} = 0$   |  | 100  | 160 | $\mu\text{A}$      |                  |
| $I_{LEAK}$    | Input Leakage Current                     | Disabled, OUT grounded   |  |      | 1   | $\mu\text{A}$      |                  |
| $I_{REV}$     | Reverse Leakage Current                   | Disabled, $V_{IN} = 0\text{V}$ , $V_{OUT} = 5\text{V}$ , $I_{REV}$ at $V_{IN}$               |  | 1    |     | $\mu\text{A}$      |                  |
| $R_{DS(ON)}$  | Switch on-resistance                      | $V_{IN} = 5\text{V}$ ,<br>$I_{OUT} = 0.5\text{A}$  | MSOP-8L-EP, $-40^\circ\text{C} \leq T_A \leq 85^\circ\text{C}$ |      | 115 | 150                | $\text{m}\Omega$ |
|               |   |  | SOP-8L, $-40^\circ\text{C} \leq T_A \leq 85^\circ\text{C}$     |      | 120 | 160                | $\text{m}\Omega$ |
|               |   | $V_{IN} = 3.3\text{V}$ ,<br>$I_{OUT} = 0.5\text{A}$  | $-40^\circ\text{C} \leq T_A \leq 85^\circ\text{C}$             |      | 140 | 180                | $\text{m}\Omega$ |
| $I_{SHORT}$   | Short-circuit current limit               | Enabled into short circuit, $C_L = 68\mu\text{F}$  |  | 2.0  |     | A                  |                  |
| $I_{LIMIT}$   | Over-Load Current Limit                   | $V_{IN} = 5\text{V}$ ,<br>$V_{OUT} = 4.5\text{V}$ ,<br>$C_L = 68\mu\text{F}$                 | 1.6  | 2.1  | 2.6 | A                  |                  |
| $I_{TRIG}$    | Current limiting trigger threshold        | $V_{IN} = V_{EN}$ , Output Current Slew rate ( $< 100\text{A/s}$ ),<br>$C_L = 68\mu\text{F}$ |  | 3.0  |     | A                  |                  |
| $V_{IL}$      | EN Input Logic Low Voltage                | $V_{IN} = 2.7\text{V}$ to $5.5\text{V}$  |  |      | 0.8 | V                  |                  |
| $V_{IH}$      | EN Input Logic High Voltage               | $V_{IN} = 2.7\text{V}$ to $5.5\text{V}$  | 2  |      |     | V                  |                  |
| $I_{SINK}$    | EN Input leakage                          | $V_{EN} = 5\text{V}$   |  |      | 1   | $\mu\text{A}$      |                  |
| $T_{D(ON)}$   | Output turn-on delay time                 | $C_L = 1\mu\text{F}$ , $R_{load} = 10\Omega$   |  | 0.05 |     | ms                 |                  |
| $T_R$         | Output turn-on rise time                  | $C_L = 1\mu\text{F}$ , $R_{load} = 10\Omega$   |  | 0.6  | 1.5 | ms                 |                  |
| $T_{D(OFF)}$  | Output turn-off delay time                | $C_L = 1\mu\text{F}$ , $R_{load} = 10\Omega$   |  | 0.01 |     | ms                 |                  |
| $T_F$         | Output turn-off fall time                 | $C_L = 1\mu\text{F}$ , $R_{load} = 10\Omega$   |  | 0.05 | 0.1 | ms                 |                  |
| $R_{FLG}$     | FLG output FET on-resistance              | $I_{FLG} = 10\text{mA}$  |  | 30   | 50  | $\Omega$           |                  |
| $T_{Blank}$   | FLG blanking time                         | $C_{IN} = 10\mu\text{F}$ , $C_L = 68\mu\text{F}$   | 4  | 7    | 15  | ms                 |                  |
| $T_{SHDN}$    | Thermal shutdown threshold                | Enabled, $R_{load} = 1\text{k}\Omega$  |  | 140  |     | $^\circ\text{C}$   |                  |
| $T_{HYS}$     | Thermal shutdown hysteresis               |  |  | 25   |     | $^\circ\text{C}$   |                  |
| $\theta_{JA}$ | Thermal Resistance<br>Junction-to-Ambient | SOP-8L (Note 4)  |  | 110  |     | $^\circ\text{C/W}$ |                  |
|               |   | MSOP-8L-EP (Note 5)  |  | 60   |     | $^\circ\text{C/W}$ |                  |

- Notes:
4. Test condition for SOP-8L: Device mounted on FR-4 2-layer board, 2oz copper, with minimum recommended pad layout.
  5. Test condition for MSOP-8L-EP: Device mounted on FR-4 2-layer board, 2oz copper, with minimum recommended pad on top layer and 3 vias to bottom layer ground plane.

**Typical Performance Characteristics**

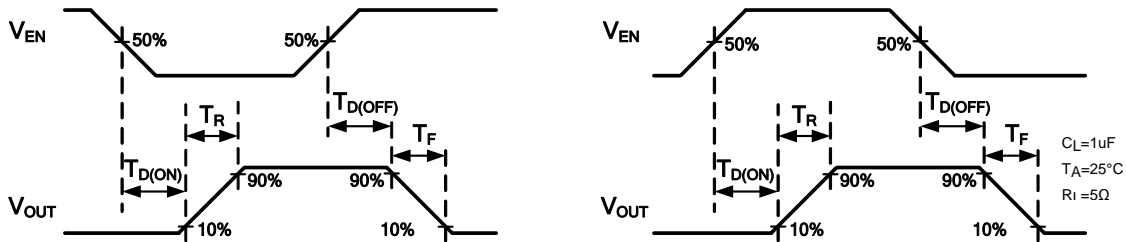
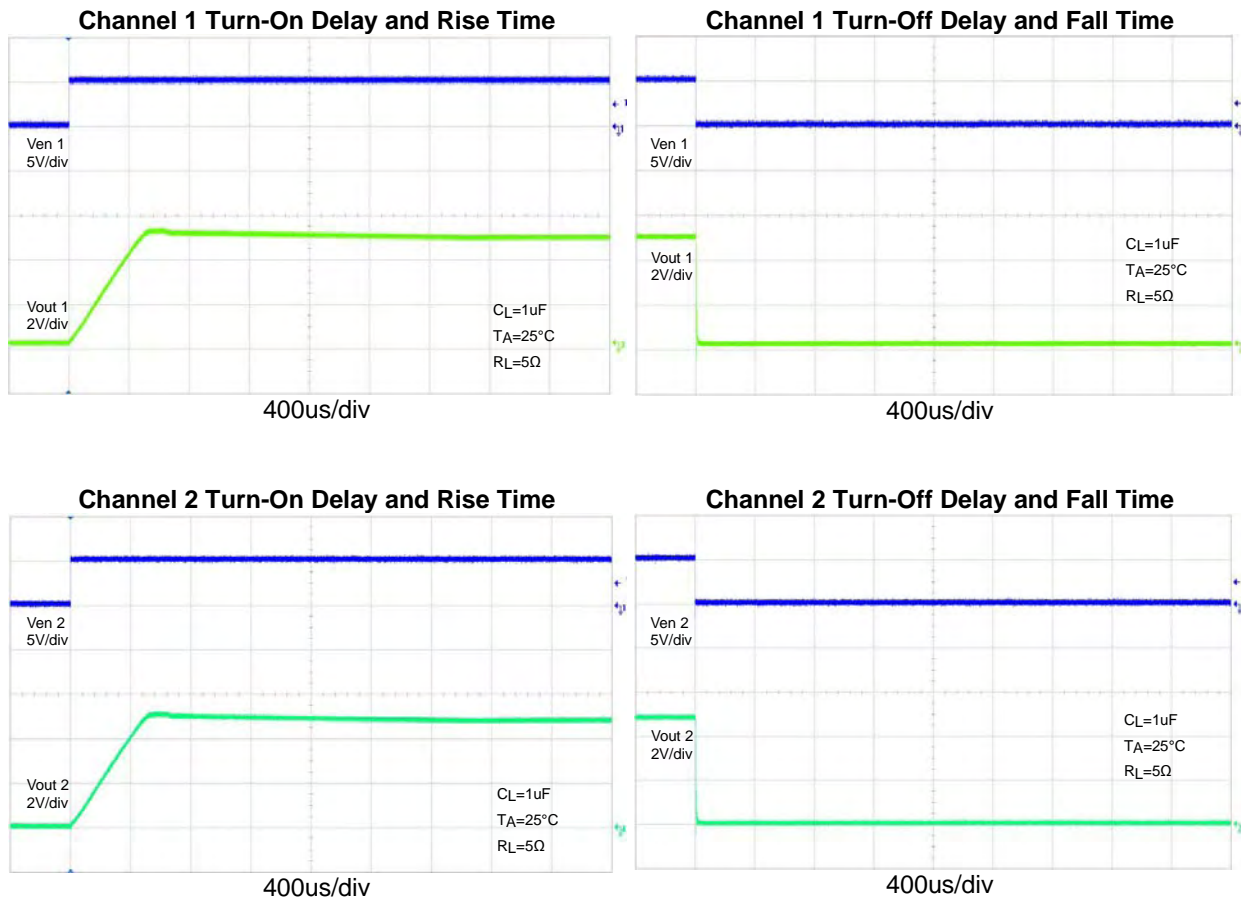
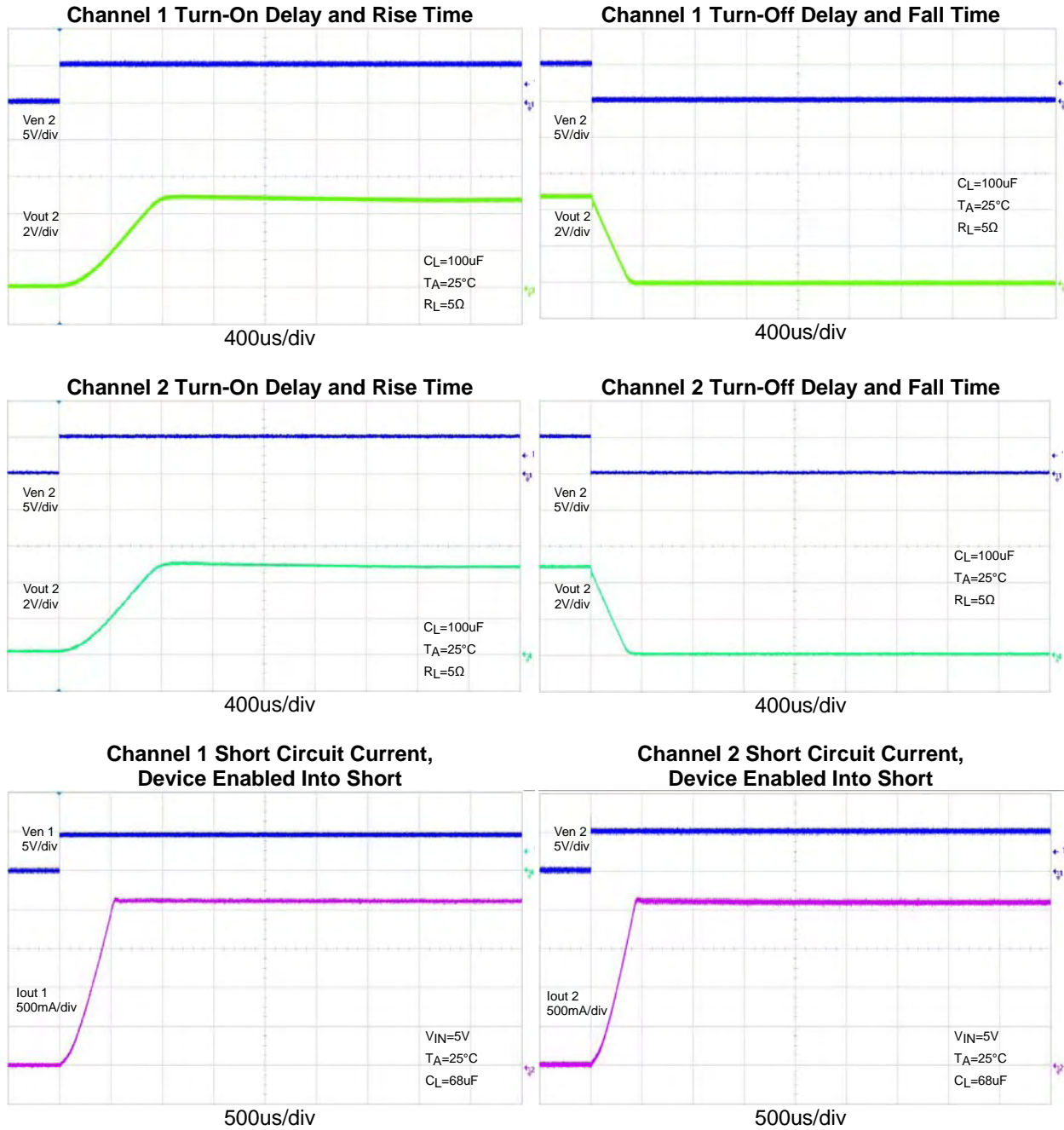

Figure 1. Voltage Waveforms: AP2182 (left), AP2192 (right)

All Enable Plots are for AP2192 Active High



**Typical Performance Characteristics (Continued)**



**Typical Performance Characteristics (Continued)**

**Channel 1 Inrush Current**

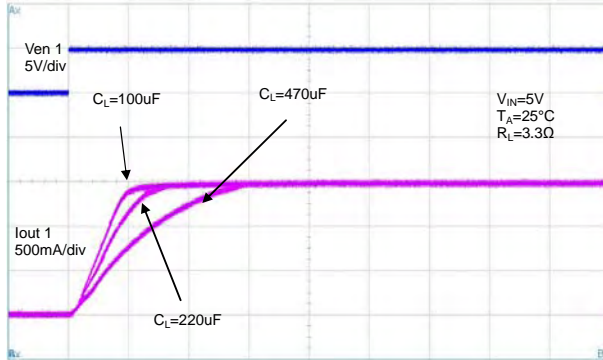

**Channel 2 Inrush Current**

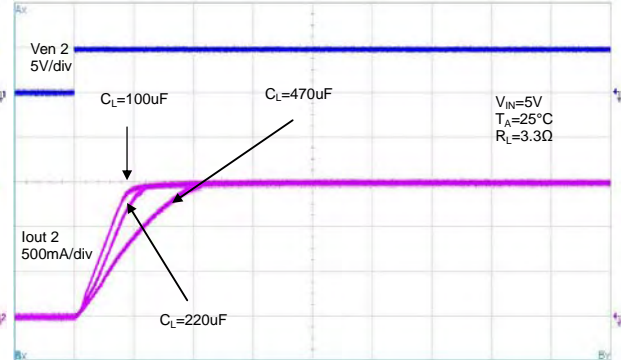

**Channel 1  
0.6 Ω Load Connected to Enabled Device**

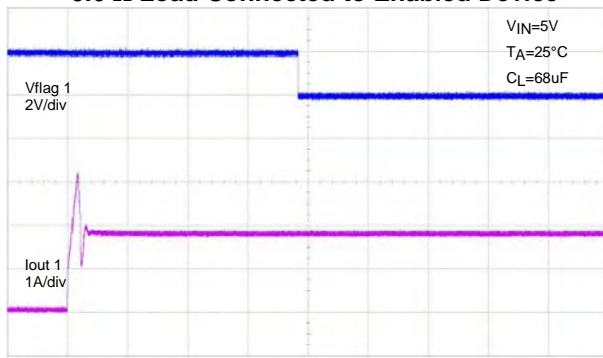

**Channel 2  
0.6 Ω Load Connected to Enabled Device**

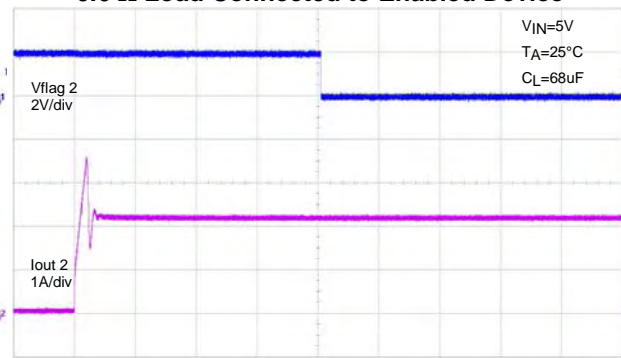

**Channel 1  
Short Circuit with Blanking Time and Recovery**

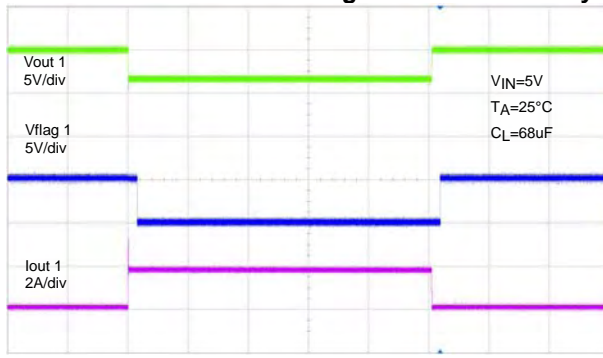

**Channel 2  
Short Circuit with Blanking Time and Recovery**

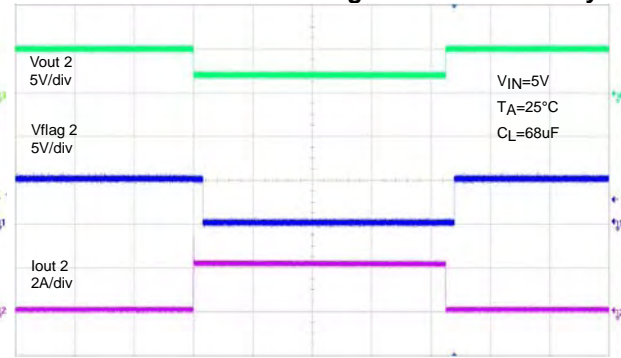



**Typical Performance Characteristics (Continued)**

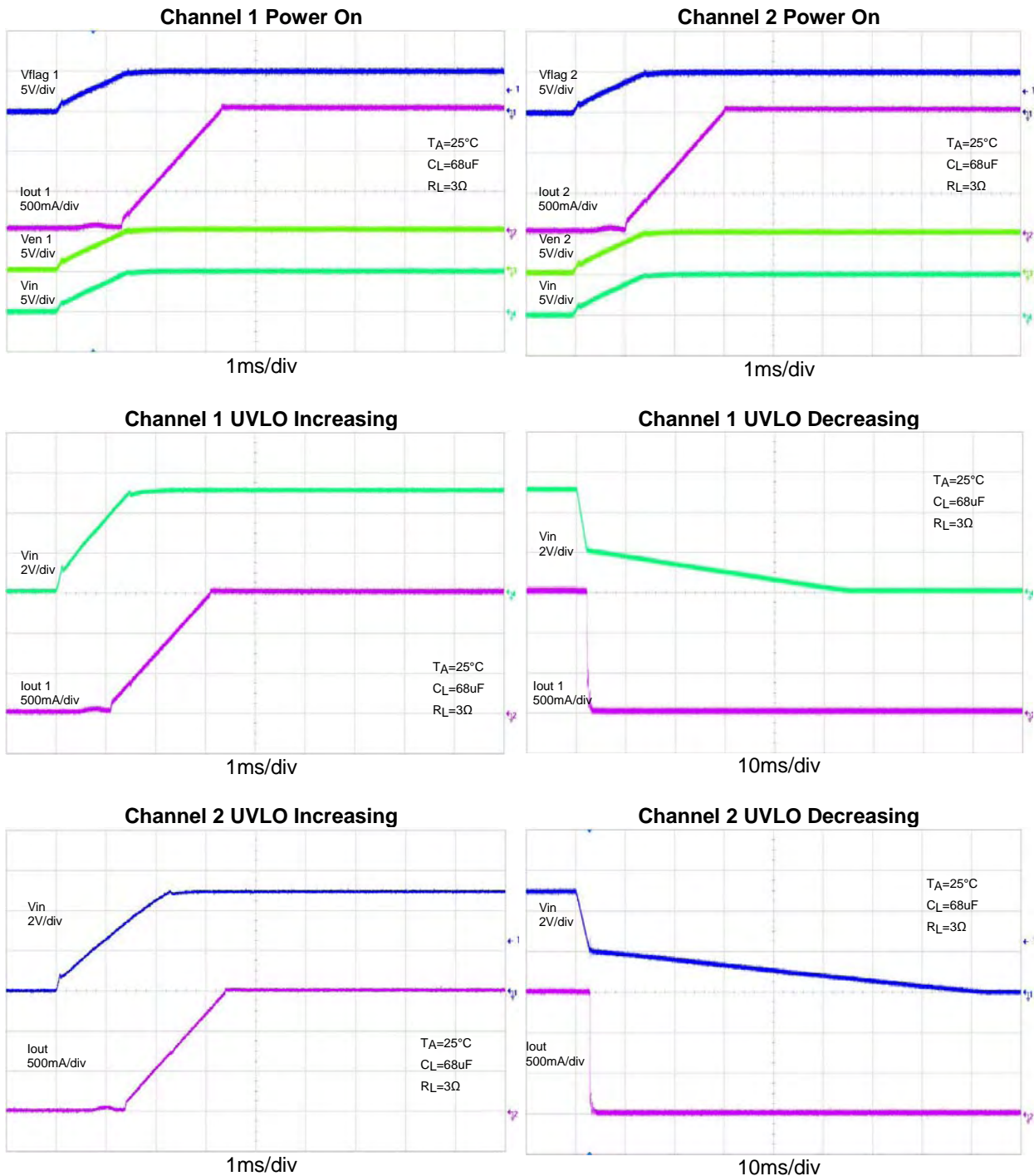

**Typical Performance Characteristics (Continued)**

**Channel 1 Enabled and Shorted with Channel 2 Disabled**

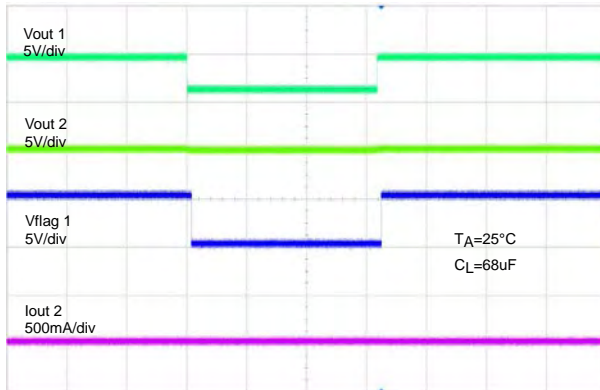

100ms/div

**Channel 1 Disabled and Channel 2 Enabled**

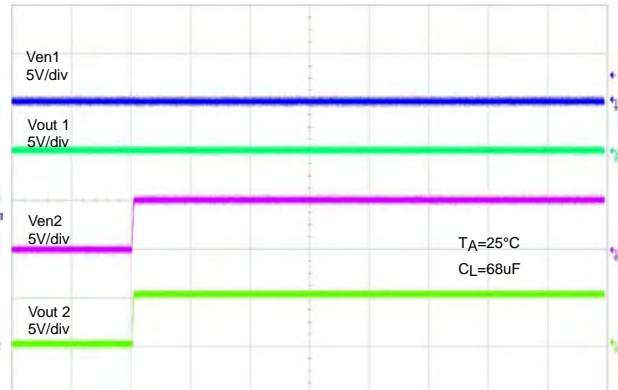

50ms/div

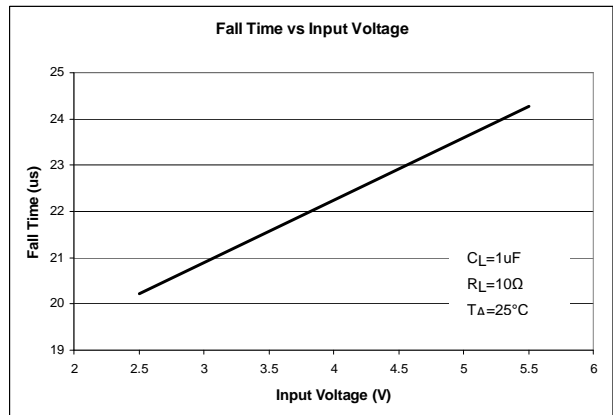
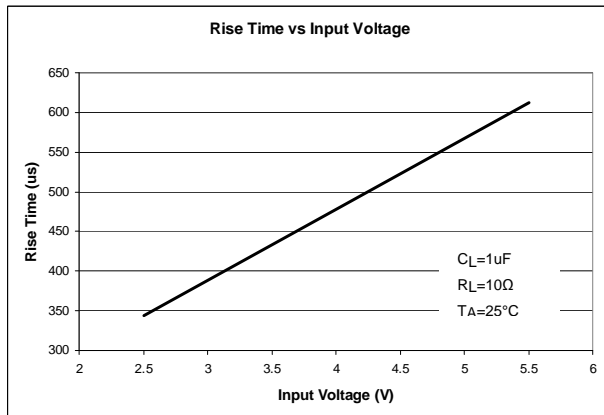
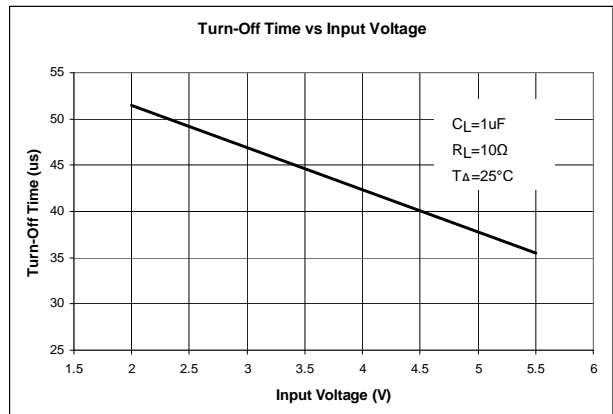
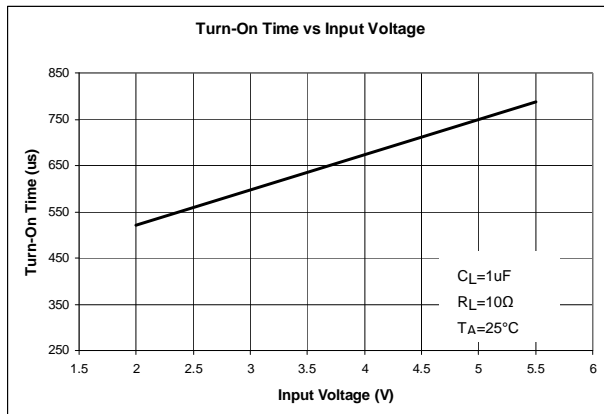

**Typical Performance Characteristics**

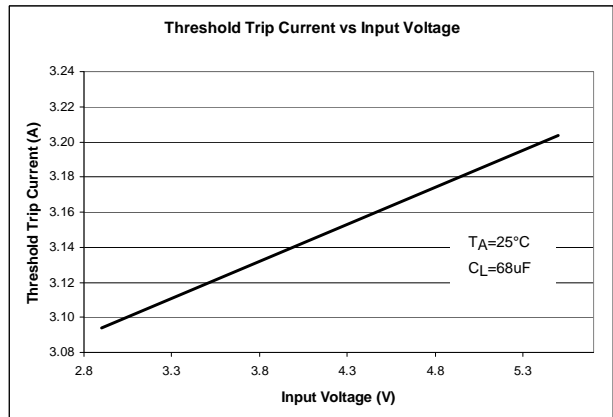
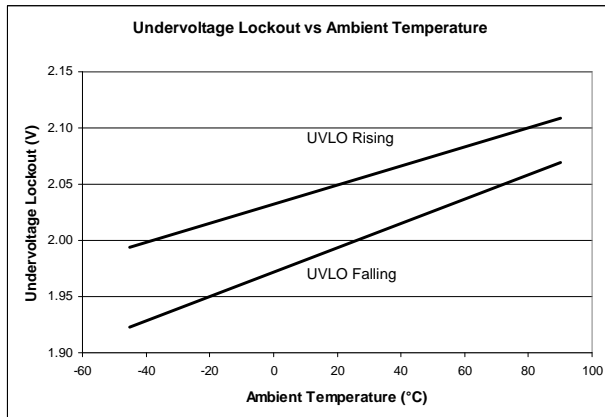
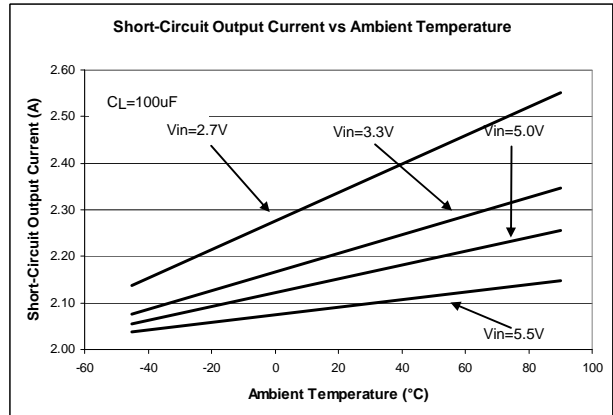
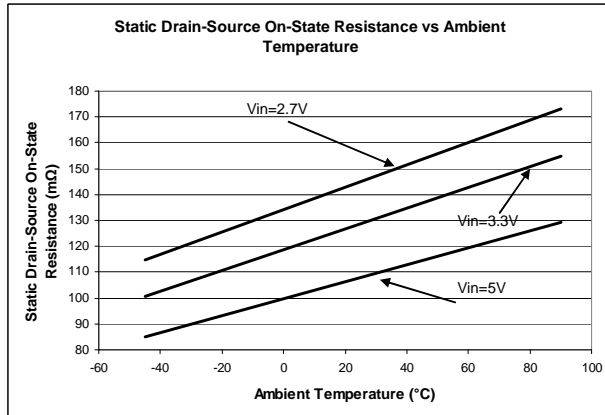
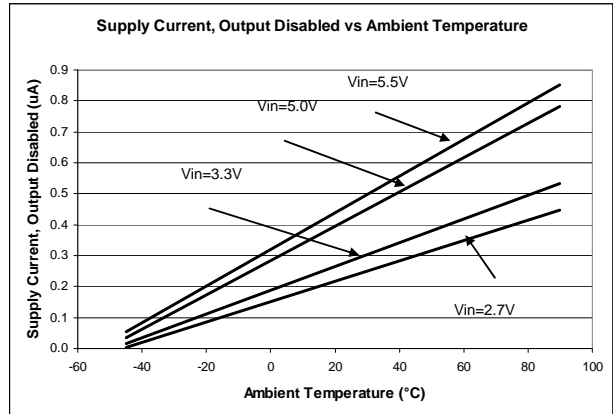
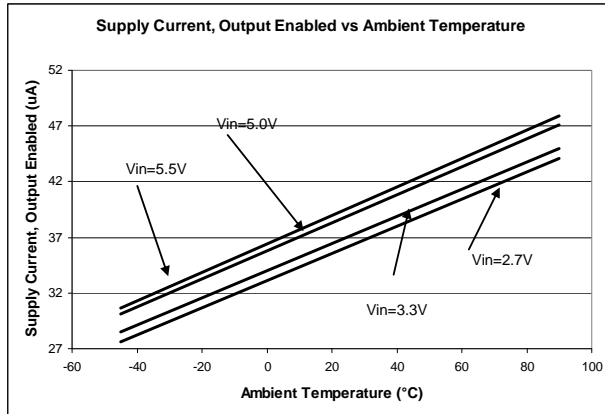

**Typical Performance Characteristics**

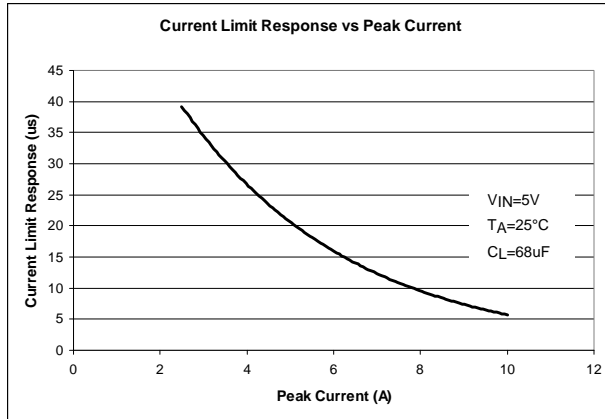

---

### Application Note

---

#### Power Supply Considerations

A 0.01- $\mu$ F to 0.1- $\mu$ F X7R or X5R ceramic bypass capacitor between IN and GND, close to the device, is recommended. Placing a high-value electrolytic capacitor on the input and output pin(s) is recommended when the output load is heavy. This precaution reduces power-supply transients that may cause ringing on the input. Additionally, bypassing the output with a 0.01- $\mu$ F to 0.1- $\mu$ F ceramic capacitor improves the immunity of the device to short-circuit transients.

#### Over-current and Short Circuit Protection

An internal sensing FET is employed to check for over-current conditions. Unlike current-sense resistors, sense FETs do not increase the series resistance of the current path. When an overcurrent condition is detected, the device maintains a constant output current and reduces the output voltage accordingly. Complete shutdown occurs only if the fault stays long enough to activate thermal limiting.

Three possible overload conditions can occur. In the first condition, the output has been shorted to GND before the device is enabled or before  $V_{IN}$  has been applied. The AP2182/AP2192 senses the short circuit and immediately clamps output current to a certain safe level namely  $I_{LIMIT}$ .

In the second condition, an output short or an overload occurs while the device is enabled. At the instance the overload occurs, higher current may flow for a very short period of time before the current limit function can react. After the current limit function has tripped (reached the over-current trip threshold), the device switches into current limiting mode and the current is clamped at  $I_{LIMIT}$ .

In the third condition, the load has been gradually increased beyond the recommended operating current. The current is permitted to rise until the current-limit threshold ( $I_{TRIG}$ ) is reached or until the thermal limit of the device is exceeded. The AP2182/AP2192 is capable of delivering current up to the current-limit threshold without damaging the device. Once the threshold has been reached, the device switches into its current limiting mode and is set at  $I_{LIMIT}$ .

#### FLG Response

When an over-current or over-temperature shutdown condition is encountered, the FLG open-drain output goes active low after a nominal 7-ms deglitch timeout. The FLG output remains low until both over-current and over-temperature conditions are removed. Connecting a heavy capacitive load to the output of the device can cause a momentary over-current condition, which does not trigger the FLG due to the 7-ms deglitch timeout. The AP2182/AP2192 is designed to eliminate false over-current reporting without the need of external components to remove unwanted pulses.

#### Power Dissipation and Junction Temperature

The low on-resistance of the internal MOSFET allows the small surface-mount packages to pass large current. Using the maximum operating ambient temperature ( $T_A$ ) and  $R_{DS(ON)}$ , the power dissipation can be calculated by:

$$P_D = R_{DS(ON)} \times I^2$$

Finally, calculate the junction temperature:

$$T_J = P_D \times R_{\theta JA} + T_A$$

Where:

$T_A$  = Ambient temperature °C

$R_{\theta JA}$  = Thermal resistance

$P_D$  = Total power dissipation

### Application Note (Continued)

#### Thermal Protection

Thermal protection prevents the IC from damage when heavy-overload or short-circuit faults are present for extended periods of time. The AP2182/AP2192 implements a thermal sensing to monitor the operating junction temperature of the power distribution switch. Once the die temperature rises to approximately 140°C due to excessive power dissipation in an over-current or short-circuit condition the internal thermal sense circuitry turns the power switch off, thus preventing the power switch from damage. Hysteresis is built into the thermal sense circuit allowing the device to cool down approximately 25°C before the switch turns back on. The switch continues to cycle in this manner until the load fault or input power is removed. The FLG open-drain output is asserted when an over-temperature shutdown or over-current occurs with 7-ms deglitch.

#### Under-voltage Lockout (UVLO)

Under-voltage lockout function (UVLO) keeps the internal power switch from being turned on until the power supply has reached at least 1.9V, even if the switch is enabled. Whenever the input voltage falls below approximately 1.9V, the power switch is quickly turned off. This facilitates the design of hot-insertion systems where it is not possible to turn off the power switch before input power is removed.

#### Host/Self-Powered HUBs

Hosts and self-powered hubs (SPH) have a local power supply that powers the embedded functions and the downstream ports (see Figure 2). This power supply must provide from 5.25V to 4.75V to the board side of the downstream connection under both full-load and no-load conditions. Hosts and SPHs are required to have current-limit protection and must report over-current conditions to the USB controller. Typical SPHs are desktop PCs, monitors, printers, and stand-alone hubs.

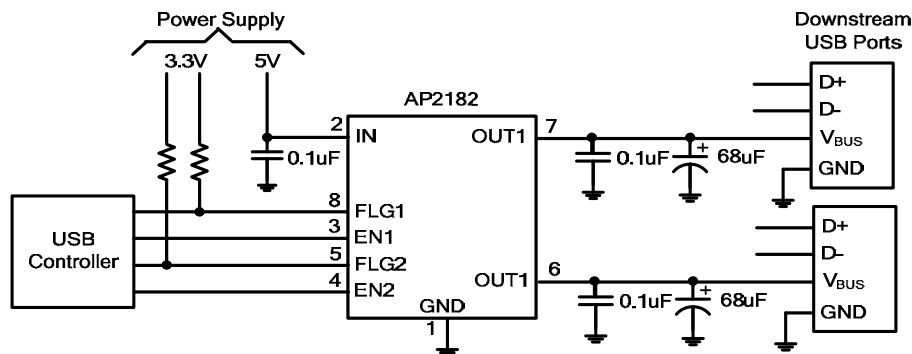

Figure 2. Typical Two-Port USB Host / Self-Powered Hub

#### Generic Hot-Plug Applications

In many applications it may be necessary to remove modules or pc boards while the main unit is still operating. These are considered hot-plug applications. Such implementations require the control of current surges seen by the main power supply and the card being inserted. The most effective way to control these surges is to limit and slowly ramp the current and voltage being applied to the card, similar to the way in which a power supply normally turns on. Due to the controlled rise times and fall times of the AP2182/AP2192, these devices can be used to provide a softer start-up to devices being hot-plugged into a powered system. The UVLO feature of the AP2182/AP2192 also ensures that the switch is off after the card has been removed, and that the switch is off during the next insertion.

By placing the AP2182/AP2192 between the Vcc input and the rest of the circuitry, the input power reaches these devices first after insertion. The typical rise time of the switch is approximately 1ms, providing a slow voltage ramp at the output of the device. This implementation controls system surge current and provides a hot-plugging mechanism for any device.

**Marking Information**

**(1) SOP-8L**

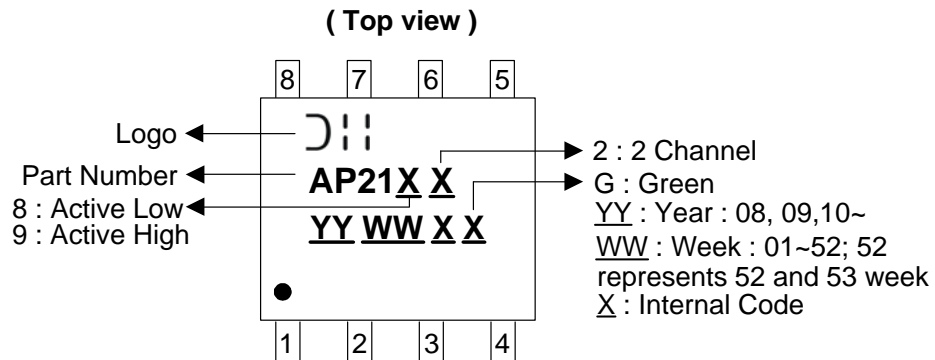

**(2) MSOP-8L-EP**

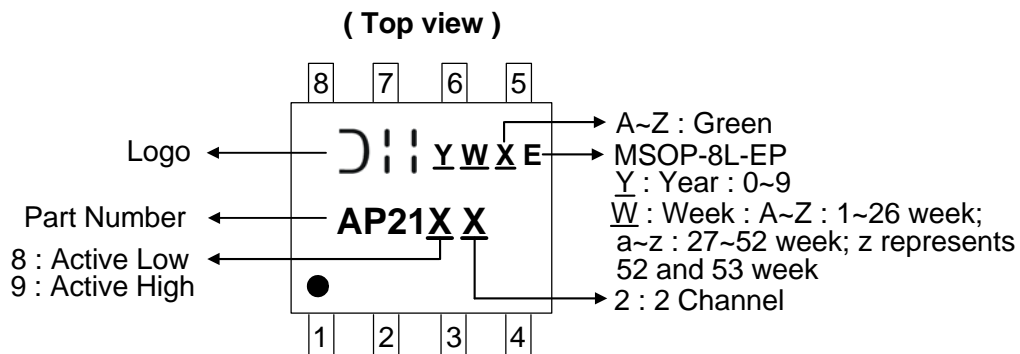

**Package Information ( All Dimensions in mm )**

**(1) Package type: SOP-8L**

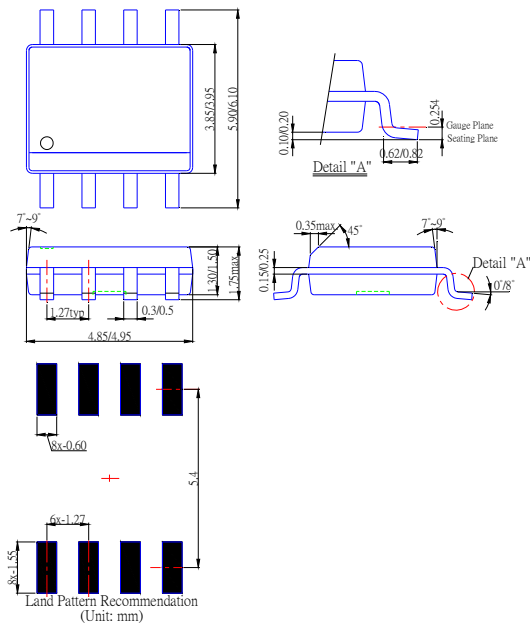

**(2) Package type: MSOP-8L-EP**

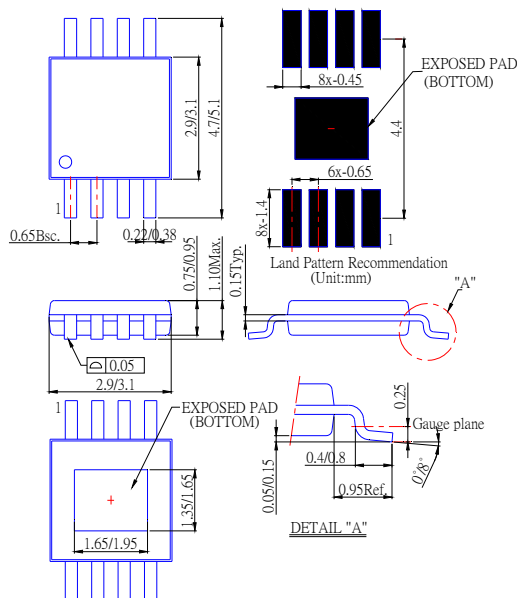



### IMPORTANT NOTICE

DIODES INCORPORATED MAKES NO WARRANTY OF ANY KIND, EXPRESS OR IMPLIED, WITH REGARDS TO THIS DOCUMENT, INCLUDING, BUT NOT LIMITED TO, THE IMPLIED WARRANTIES OF MERCHANTABILITY AND FITNESS FOR A PARTICULAR PURPOSE (AND THEIR EQUIVALENTS UNDER THE LAWS OF ANY JURISDICTION).

Diodes Incorporated and its subsidiaries reserve the right to make modifications, enhancements, improvements, corrections or other changes without further notice to this document and any product described herein. Diodes Incorporated does not assume any liability arising out of the application or use of this document or any product described herein; neither does Diodes Incorporated convey any license under its patent or trademark rights, nor the rights of others. Any Customer or user of this document or products described herein in such applications shall assume all risks of such use and will agree to hold Diodes Incorporated and all the companies whose products are represented on Diodes Incorporated website, harmless against all damages.

Diodes Incorporated does not warrant or accept any liability whatsoever in respect of any products purchased through unauthorized sales channel.

Should Customers purchase or use Diodes Incorporated products for any unintended or unauthorized application, Customers shall indemnify and hold Diodes Incorporated and its representatives harmless against all claims, damages, expenses, and attorney fees arising out of, directly or indirectly, any claim of personal injury or death associated with such unintended or unauthorized application.

Products described herein may be covered by one or more United States, international or foreign patents pending. Product names and markings noted herein may also be covered by one or more United States, international or foreign trademarks.

### LIFE SUPPORT

Diodes Incorporated products are specifically not authorized for use as critical components in life support devices or systems without the express written approval of the Chief Executive Officer of Diodes Incorporated. As used herein:

- A. Life support devices or systems are devices or systems which:
  - 1. are intended to implant into the body, or
  - 2. support or sustain life and whose failure to perform when properly used in accordance with instructions for use provided in the labeling can be reasonably expected to result in significant injury to the user.
- B. A critical component is any component in a life support device or system whose failure to perform can be reasonably expected to cause the failure of the life support device or to affect its safety or effectiveness.

Customers represent that they have all necessary expertise in the safety and regulatory ramifications of their life support devices or systems, and acknowledge and agree that they are solely responsible for all legal, regulatory and safety-related requirements concerning their products and any use of Diodes Incorporated products in such safety-critical, life support devices or systems, notwithstanding any devices- or systems-related information or support that may be provided by Diodes Incorporated. Further, Customers must fully indemnify Diodes Incorporated and its representatives against any damages arising out of the use of Diodes Incorporated products in such safety-critical, life support devices or systems.

Copyright © 2010, Diodes Incorporated

[www.diodes.com](http://www.diodes.com)