

PLEASE CHECK WWW.MOLEX.COM FOR LATEST PART INFORMATION

Part Number: [0717434080](#)
Status: **Active**
Description: 1.27mm (.050") Pitch EBBI™ 50D Receptacle, Vertical SCA-2, 80 Circuits, SMT, 2.49mm (.098") Retention Clip

Documents:

[3D Model](#) [Product Specification PS-73826-0000 \(PDF\)](#)
[Drawing \(PDF\)](#) [RoHS Certificate of Compliance \(PDF\)](#)

Agency Certification

CSA LR19980
 UL E29179

General

Product Family PCB Receptacles
 Series [71743](#)
 Application Board-to-Board
 Comments Circuits 1, 36-43, 45, 46, and 75-80 are advanced terminals for sequential first-mate/last-break mating
 Product Name EBBI™, SCA-2

Physical

Circuits (Loaded) 80
 Color - Resin Black
 Durability (mating cycles max) 500
 Flammability 94V-0
 Glow-Wire Compliant No
 Guide to Mating Part Yes
 Lock to Mating Part None
 Material - Metal Phosphor Bronze
 Material - Plating Mating Gold
 Material - Plating Termination Tin
 Material - Resin High Temperature Thermoplastic
 Number of Rows 2
 Orientation Vertical
 PCB Locator Yes
 PCB Retention Yes
 PCB Thickness Recommended (in) 0.062 In
 PCB Thickness Recommended (mm) 1.60 mm
 Packaging Type Tray
 Pitch - Mating Interface (in) 0.050 In
 Pitch - Mating Interface (mm) 1.27 mm
 Plating min: Mating (µin) 30
 Plating min: Mating (µm) 0.76
 Plating min: Termination (µin) 75
 Plating min: Termination (µm) 1.91
 Polarized to PCB Yes
 Surface Mount Compatible (SMC) N/A
 Temperature Range - Operating -40°C to +105°C
 Termination Interface: Style Surface Mount

Electrical

Current - Maximum per Contact 1A
 Voltage - Maximum 30V

Solder Process Data

Duration at Max. Process Temperature (seconds) 40

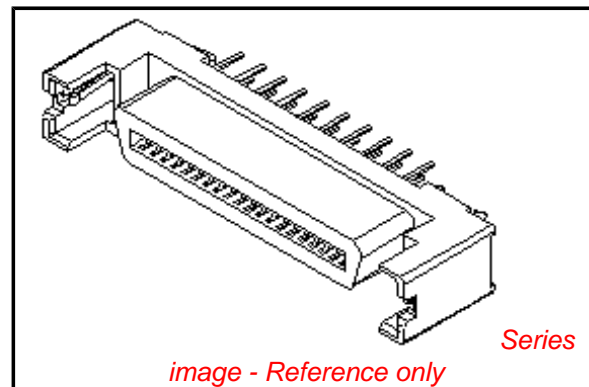

EU RoHS

ELV and RoHS Compliant
REACH SVHC Contains SVHC: No
Halogen-Free Status

China RoHS



Need more information on product environmental compliance?

Email productcompliance@molex.com
 For a multiple part number RoHS Certificate of Compliance, [click here](#)

Please visit the [Contact Us](#) section for any non-product compliance questions.

Search Parts in this Series

[71743Series](#)

Mates With

[87572](#) , [87571](#) , [87012](#)

Lead-free Process Capability	SMC & Wave Capable (TH only)
Max. Cycles at Max. Process Temperature	3
Process Temperature max. C	260

Material Info

Reference - Drawing Numbers

Product Specification	PS-73826-0000
Sales Drawing	SD-71743-003

This document was generated on 04/14/2010

PLEASE CHECK WWW.MOLEX.COM FOR LATEST PART INFORMATION

13 12 11 10 9 8 7 6 5 4 3 2 1

- NOTES: 1. MATERIAL:
 HOUSING: I.R. COMPATIBLE POLYMER, GLASS FILLED, UL 94 V 0, BLACK
 TERMINALS: COPPER ALLOY
 BOARDLOCK: COPPER ALLOY
2. FINISH:
 TERMINALS: 30 MICROINCHES / 0.76 MICROMETERS GOLD IN CONTACT AREA
 100 MICROINCHES/ 2.54 MICROMETERS TIN IN TAIL AREA
 NICKEL UNDERPLATE OVERALL.
 ESD BOARDLOCK: TIN OVER NICKEL OVERALL.
 *THE PRIMARY SHIPPING CARTON WILL BE LABELED 'COMPLIANT TO
 RoHS DIRECTIVE 2002/95/EC AND ELV ANNEX II OF DIRECTIVE 2000/53/EC'.
 CARTONS WITHOUT THIS LABEL MAY CONTAIN PRODUCT WITH LEAD.
3. PRODUCT SPECIFICATION: PS-73826-0000
4. FOUR DIGIT DATE CODE IN THIS LOCATION (WK YR).
5. CONTACT GAP WILL ACCOMMODATE MATING CONNECTOR OF:
 .063+/-0.003 / 1.60+/-0.08
6. PACKAGE PER SPECIFICATION PK-70873-5025.
7. CIRCUIT NUMBERS 1,36 THRU 43, 45, 46, AND 75 THRU 80,
 ARE ADVANCED (LONG) TERMINALS FOR SEQUENTIAL MATING.
8. COPLANARITY TO BE MEASURED USING FIXTURE * 71743-9001 OR EQUIVALENT.
 MEASUREMENT TO BE TAKEN AT 50X MAGNIFICATION.
 COPLANARITY IS THE DISTANCE BETWEEN THE SEATING PLANE AND THE LOWEST
 POINT ON THE SMT TAIL THAT IS FARTHEST AWAY FROM THE SEATING PLANE.
 FIXTURING TO BE SUCH THAT ALL TAILS ARE OVER THE SEATING PLANE.

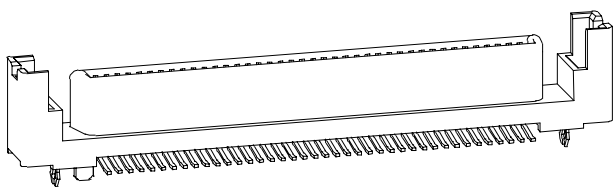
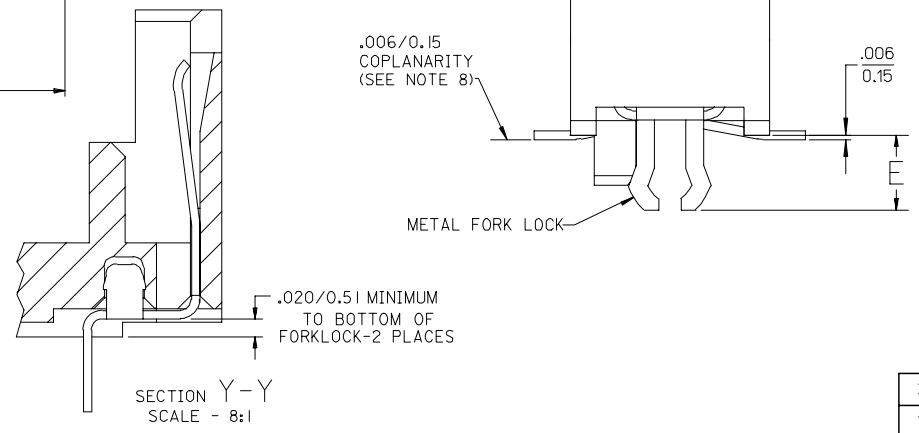
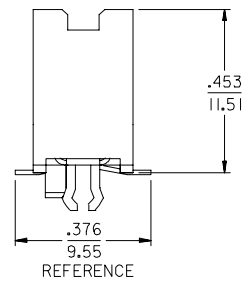
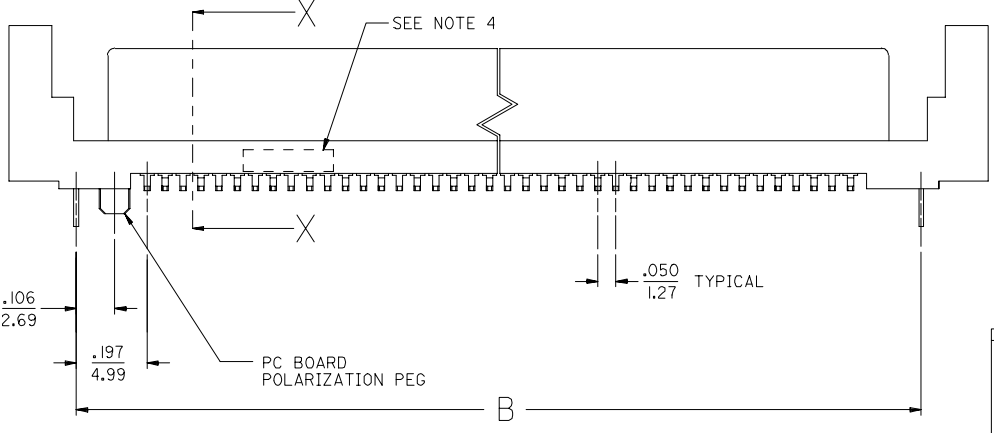
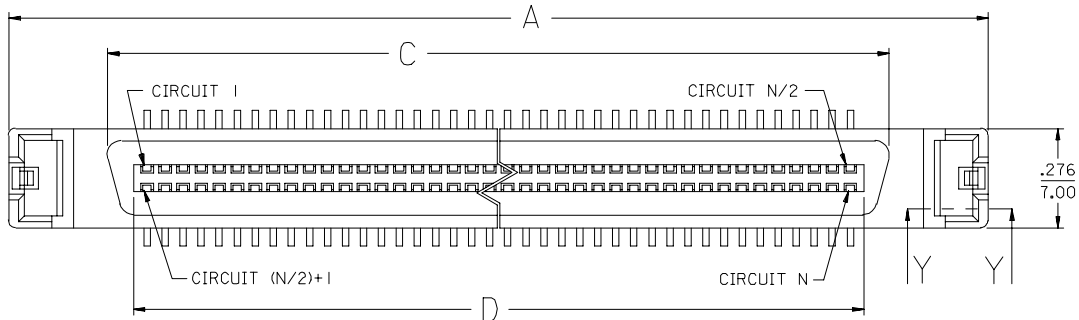

2	E
1	E
SHT	REV

ADD PART NUMBERS EC NO: UCP2006-0819 DRAWN: BBARKER CHKD: SMILLER APPR: SMILLER 2005/10/20 2005/10/21 2005/10/21	QUALITY SYMBOLS ▽=0 ▽=0	GENERAL TOLERANCES (UNLESS SPECIFIED)		DIMENSION STYLE IN/MM		SCALE 4:1	DESIGN UNITS INCH	THIRD ANGLE PROJECTION	
		4 PLACES ± .010	± .010	DRAWN BY	DATE	TITLE			
		3 PLACES ± .010	± .010	RLWHITE	03/05/15	SALES DRAWING - ASSEMBLY			
		2 PLACES ± 0.25	± .010	BBARKER	03/05/15	EBBI VERTICAL RECEPTACLE			
1 PLACE ± .010	± .010	APPROVED BY	DATE	SMT SCA-2 CONNECTOR					
ANGULAR ±1/2°		SMILLER	03/05/15	MATERIAL NO.		DOCUMENT NO.		SHEET NO.	
DRAFT WHERE APPLICABLE MUST REMAIN WITHIN DIMENSIONS		SEE CHART		SD-71743-003		MOLEX INCORPORATED		1 OF 2	
THIS DRAWING CONTAINS INFORMATION THAT IS PROPRIETARY TO MOLEX INCORPORATED AND SHOULD NOT BE USED WITHOUT WRITTEN PERMISSION									

12 11 10 9 8 7 6 5 4 3 2 1

	13	12	11	10	9	8	7	6	5	4	3	2	1
	MATERIAL NUMBER		DIMENSION E	CIRCUIT SIZE (N)	DIMENSION A	DIMENSION B	DIMENSION C	DIMENSION D	DIMENSION F	ADVANCED TERMINALS / CIRCUITS (SECTION Z-Z, SHEET I)			
J	71743-4040		.098/2.49	40	1.717/43.61	1.343/34.11	1.168/29.67	1.025/26.04	.950/24.13	21, 22, 23, 26, 29, 32, 35, 36, 37, 38, 39, 40			
	71743-4240		.118/3.00										
I	71743-4080		.098/2.49	80	2.717/69.01	2.343/59.51	2.168/55.07	2.025/51.44	1.950/49.53	1, 36, 37, 38, 39, 40, 41, 42, 43, 45, 46, 75, 76, 77, 78, 79, 80			
	71743-4280		.118/3.00										

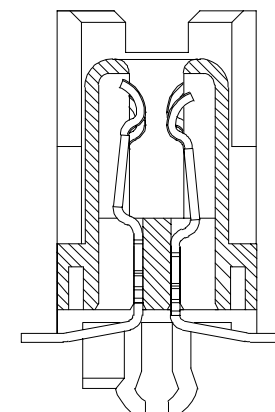
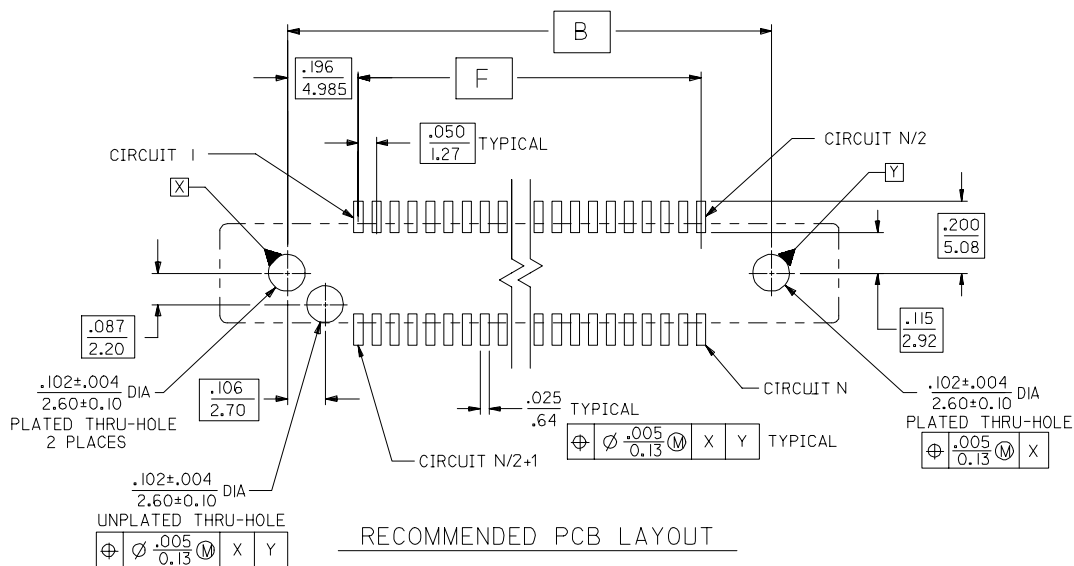

SECTION X-X
SCALE - 8:1

ADD PARTS EC NO: UCP2006-0819 2005/10/20 DRAWN: BBARKER 2005/10/21 CHKD: HSWART 2005/10/21 APPR: SMILLER 2005/10/21 REVISION DESCRIPTION	GENERAL TOLERANCES (UNLESS SPECIFIED)		DIMENSION STYLE IN/MM		SCALE 4:1	DESIGN UNITS INCH	THIRD ANGLE PROJECTION
	4 PLACES ± --- ± ---	3 PLACES ± --- ± .010	2 PLACES ± 0.25 ± ---	1 PLACE ± --- ± ---	DRAWN BY RWHITE	DATE 03/05/15	TITLE SALES DRAWING - ASSEMBLY EBBI VERTICAL RECEPTACLE SMT SCA-2 CONNECTOR
	ANGULAR ±1/2°				CHECKED BY BBARKER	DATE 03/05/15	MOLEX INCORPORATED DOCUMENT NO. SD-71743-003 SHEET NO. 2 OF 2
	DRAFT WHERE APPLICABLE MUST REMAIN WITHIN DIMENSIONS				APPROVED BY SMILLER	DATE 03/05/15	
SEE CHART			MATERIAL NO.		THIS DRAWING CONTAINS INFORMATION THAT IS PROPRIETARY TO MOLEX INCORPORATED AND SHOULD NOT BE USED WITHOUT WRITTEN PERMISSION		