

CHARACTER TYPE LCD MODULE

PVC160203PGL01

PRODUCT SPECIFICATIONS

Picvue Confidential

CAUTION

The product described by these specifications is designed to be used with ordinary electronic equipment or devices, such as audio/video equipment, office-automation equipment, communication devices, and other. Should you intend to use this product with equipment or devices that could endanger or affect human life (such as medical instruments, transportation equipment, aerospace machinery, nuclear-reactor controllers, fuel controllers, and all other safety devices and equipment), please be sure to consult our sales representatives in advance.

碧悠電子股份有限公司
PICVUE ELECTRONICS CO., LTD.
TEL: + 886-35-596145
FAX: + 886-35-596149

新竹縣新豐鄉建興路二段468巷12號
NO. 12, LANE 468, SEC. 2
CHIEN-HSING RD, HSING-FUNG
HSIN-CHU, TAIWAN R. O. C.

TABLE OF CONTENTS

1.0 COMPOSITION	5
2.0 MECHANICAL SPECIFICATIONS	5
3.0 DIMENSIONAL DIAGRAM.....	5
4.0 OPTICAL CHARACTERISTICS	6
4.1 θ AND ϕ	6
4.2 CONTRAST RATIO CR	7
4.3 RESPONSE TIMES T_R AND T_F	7
4.4 OPTICAL MEASUREMENT SYSTEM	8
5.0 ELECTRICAL SPECIFICATIONS	9
5.1 POWER SUPPLY CIRCUIT DIAGRAM	9
6.0 INTERFACE PIN DESCRIPTION	10
7.0 BLOCK DIAGRAM.....	10
8.0 AC CHARACTERISTICS.....	11
8.1 INTERFACE TIMING	10
8.2 COMMAND	15
9.0 SPECIFICATIONS OF LED BACKLIGHT:.....	17
10.0 MAXIMUM ABSOLUTE VALUES	17
11.0 RELIABILITY.....	18
12.0 COSMETIC CRITERIA OF LCD SCREEN	19
13.0 PRECAUTIONS	20
13.1 STATIC CHARGE	20
13.2 POWER ON SEQUENCE	20
13.3 OPERATION	20
13.4 PACKAGING	20
13.5 LONG-TERM STORAGE	21
13.6 CLEANING OF THE PRODUCT.....	21
14.0 FINAL REMARKS	21
APPENDIX —.....	22

Picvue Confidential

1.0 COMPOSITION

Display type: 16 CHARACTERS × 2 LINES DOTs-Matrix LCD Module
 Driving method: 1/16 DUTY 1/5 BIAS
 View Direction: 6 O' clock
 Backlight: LED (YELLOW / GREEN)

2.0 MECHANICAL SPECIFICATIONS

ITEM	STANDARD VALUES	UNITS
LCD type	STN Transflective/Positive	
Dot arrangement	16 Characters × 2 Lines	dots
Module size	84.0 (W) × 44.0 (H) × 13.0 (D)	mm
View area	61.0 (W) × 17.6 (H)	mm
Active area	56.2 (W) × 11.5 (H)	mm
Dot size	0.55 (W) × 0.55 (H)	mm
Dot pitch	0.65 (W) × 0.7 (H)	mm
Viewing direction	6 O' clock	
Weight	45.0	g

3.0 DIMENSIONAL DIAGRAM

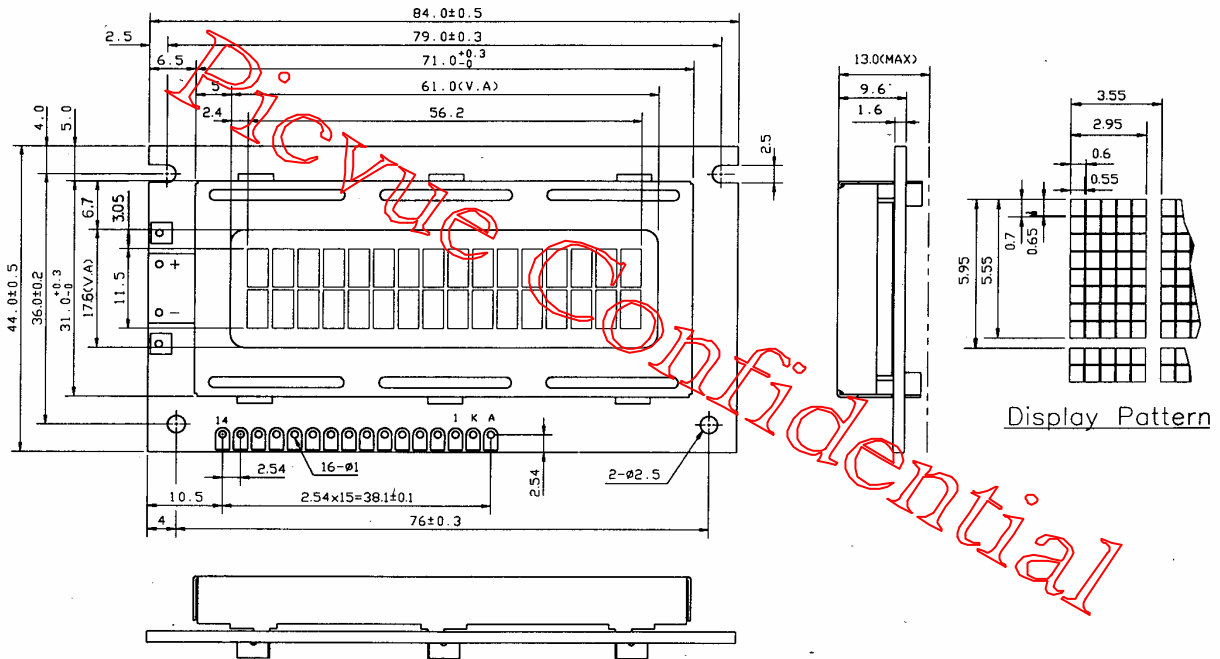

4.0 OPTICAL CHARACTERISTICS

ITEM	SYMBOL	CONDITIONS	MIN	TYP	MAX	UNITS	
Viewing Angle	θ	$T_a = 25\text{ }^\circ\text{C}$ $C_r \geq 2.0$	$\phi = 0^\circ$	—	40	—	Deg
			$\phi = 180^\circ$	—	30	—	
			$\phi = 90^\circ$	—	30	—	
			$\phi = 270^\circ$	—	30	—	
Contrast Ratio	C_r (MAX)	$T_a = 25\text{ }^\circ\text{C}$	6	10	—		
Response Time	T_R	$T_a = 25\text{ }^\circ\text{C}$	—	65	110	ms	
	T_F		—	125	220		
Frame Frequency	f_{FLM}	—	—	78	—	Hz	

4.1 θ and ϕ

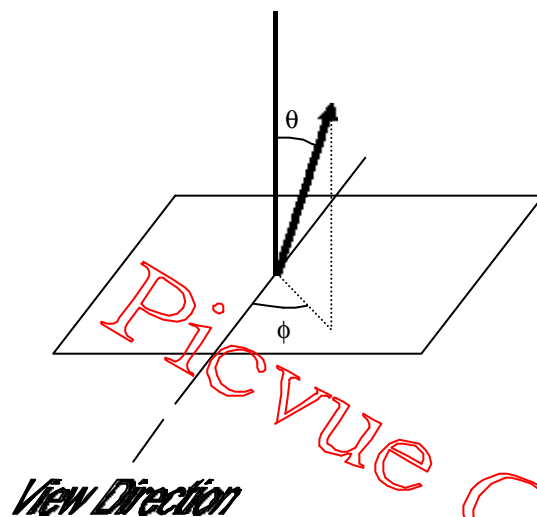

- The contrast of the display is optimal when viewed in the “View Direction” ($\theta = 0^\circ$).
- $0^\circ \leq \theta < 90^\circ$; $0^\circ \leq \phi < 360^\circ$

4.2 Contrast ratio Cr

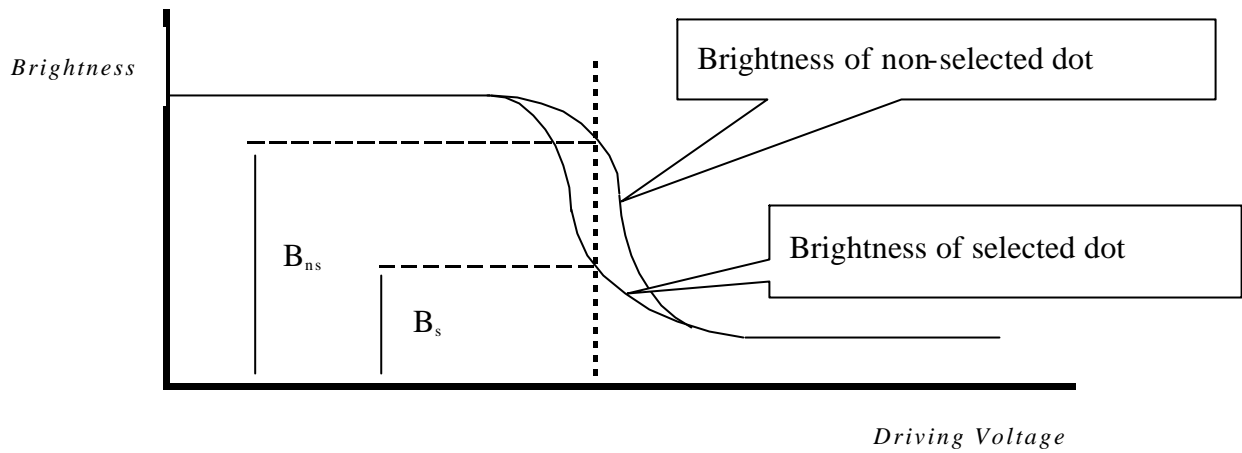

$$\text{Contrast Ratio: } C_r = B_{ns} / B_s$$

4.3 Response times T_R and T_F

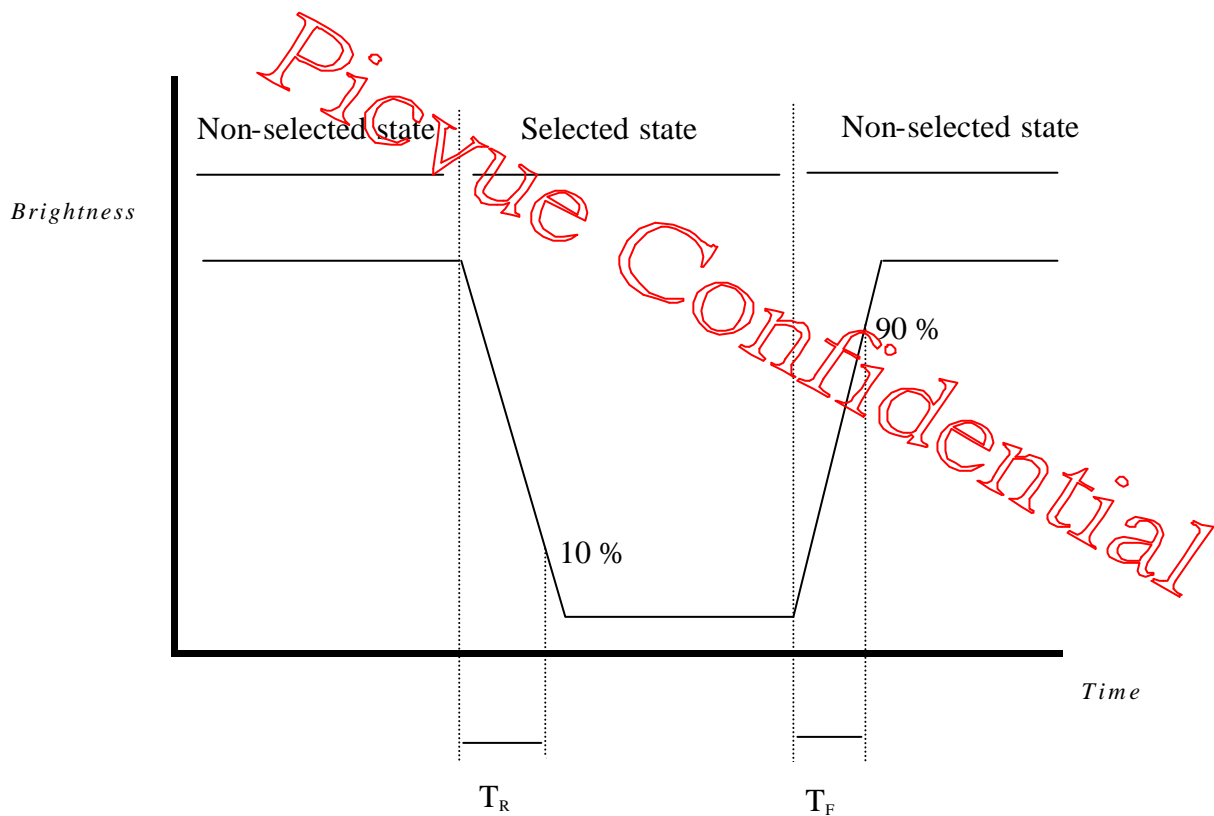

4.4 Optical measurement system

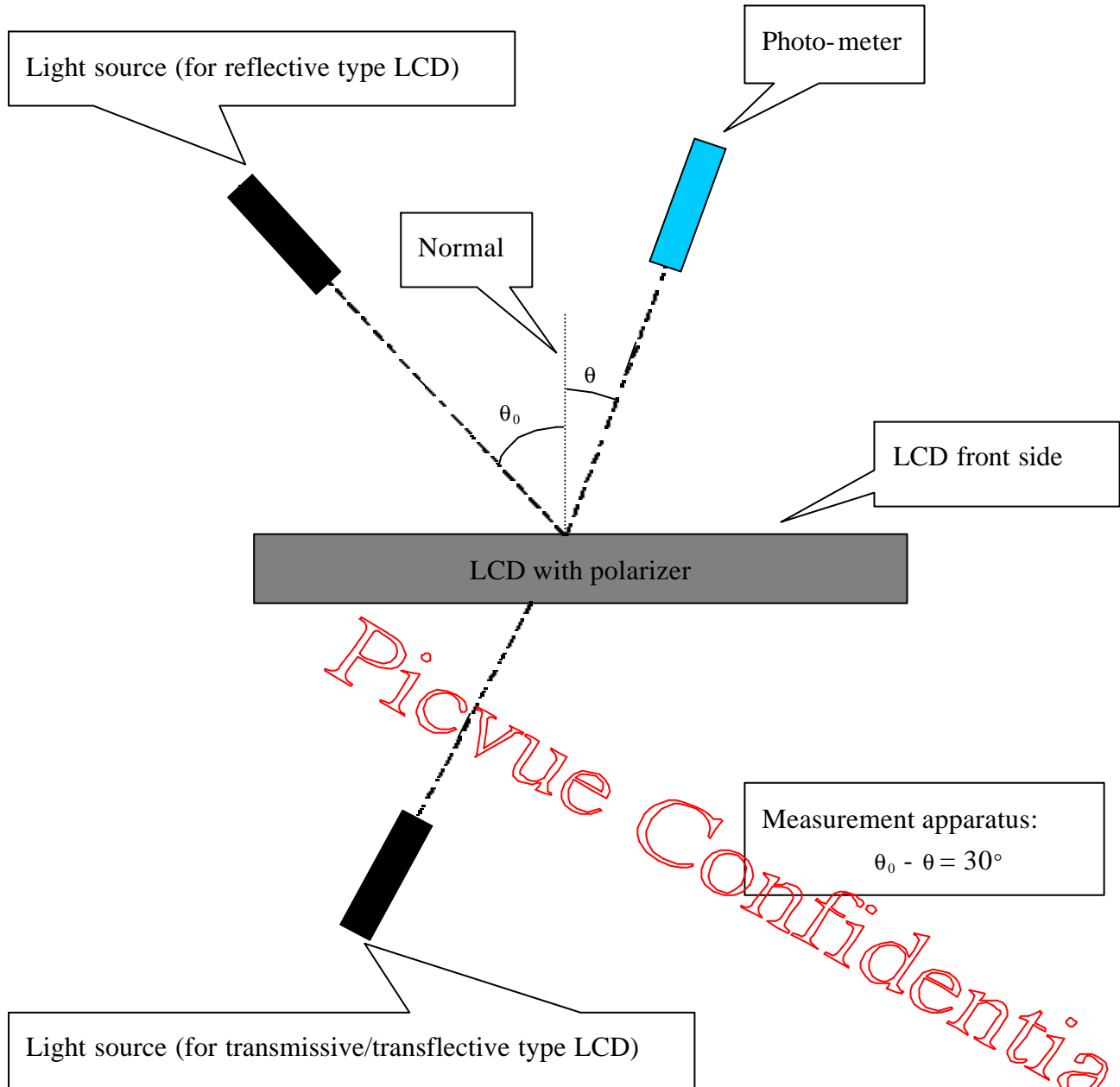

5.0 ELECTRICAL SPECIFICATIONS

ITEM	SYMBOL	MIN	TYP	MAX	UNITS
Power-supply voltage	V_{DD}	4.7	5.0	5.3	V
Power-supply current	I_{DD} ($V_{DD}=5V$)	-	1.6	2.5	mA
Vop output voltage	V_O	----	4.5	----	V
Input voltage	V_{IH}	$0.8V_{DD}$	-	V_{DD}	V
	V_{IL}	0	-	$0.2V_{DD}$	

5.1 POWER SUPPLY CIRCUIT DIAGRAM

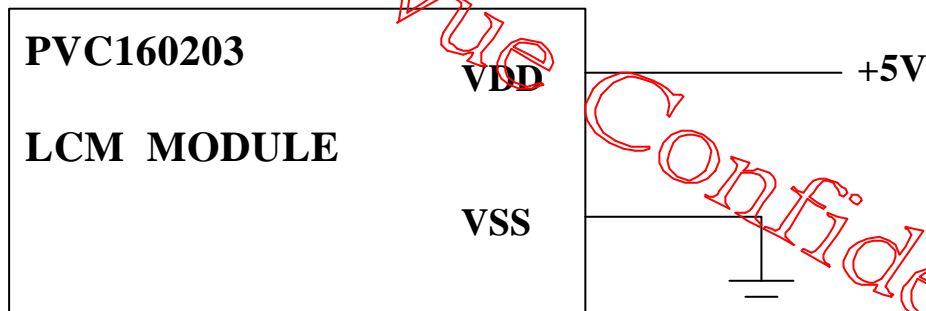

6.0 INTERFACE PIN DESCRIPTION

PIN NO.	SYMBOL	I/O	FUNCTION
1	V _{ss}	I	Ground
2	V _{DD}	I	Power Supply for Logic
3	V _o	O	Power Supply for LCD
4	RS	I	Register select . H : Data L : Instruction.
5	R/W	I	READ /WRITE
6	E	I	ENABLE SIGNAL
7~14	DB0 ~ DB7	I	Data BUS
15	NC		
16	NC		

7.0 BLOCK DIAGRAM

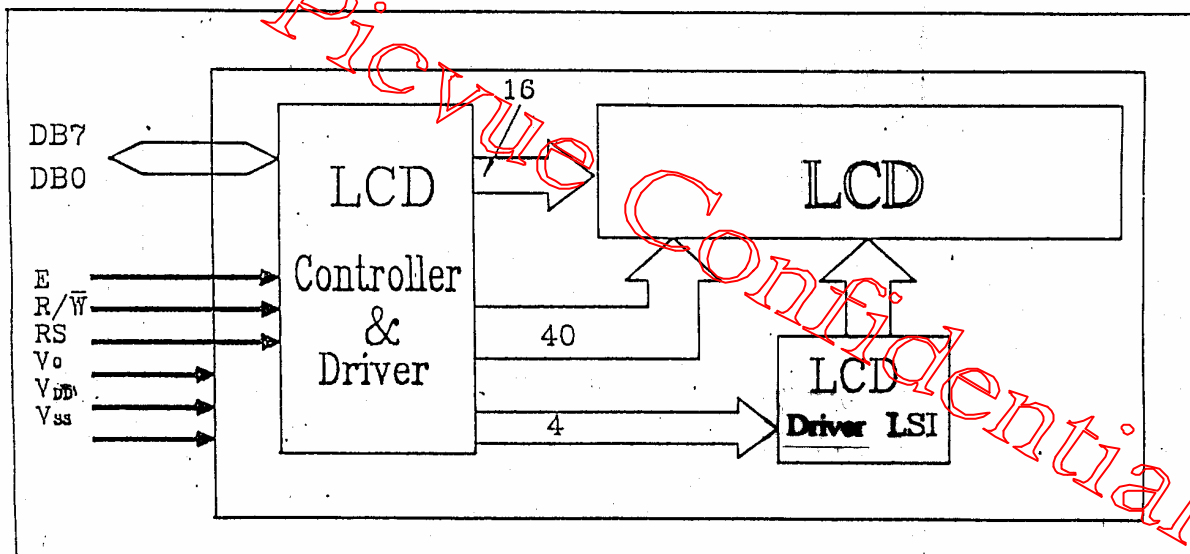

8.0 AC CHARACTERISTICS

8.1 INTERFACE TIMING

Read Cycle ($T_a=25^\circ\text{C}$, $V_{dd}=5\text{V}$)

Symbol	Parameter	Min	Typ	Max	Unit	Conditions
t_{CYCE}	Enable Cycle Time	500	—	—	ns	Figure 1
t_{WEM}	Enable "H" Level Pulse Width	300	—	—	ns	Figure 1
$t_{\text{RE}}, t_{\text{FE}}$	Enable Rise/Fall Time	—	—	25	ns	Figure 1
t_{AS}	RS, R/W Setup Time	60	—	—	ns	Figure 1
t_{AH}	RS, R/W Address Hold Time	10	—	—	ns	Figure 1
t_{RD}	Read Data Output Delay	—	—	190	ns	Figure 1
t_{DHR}	Read Data Hold Time	20	—	—	ns	Figure 1

Timing Waveforms

Read Operation

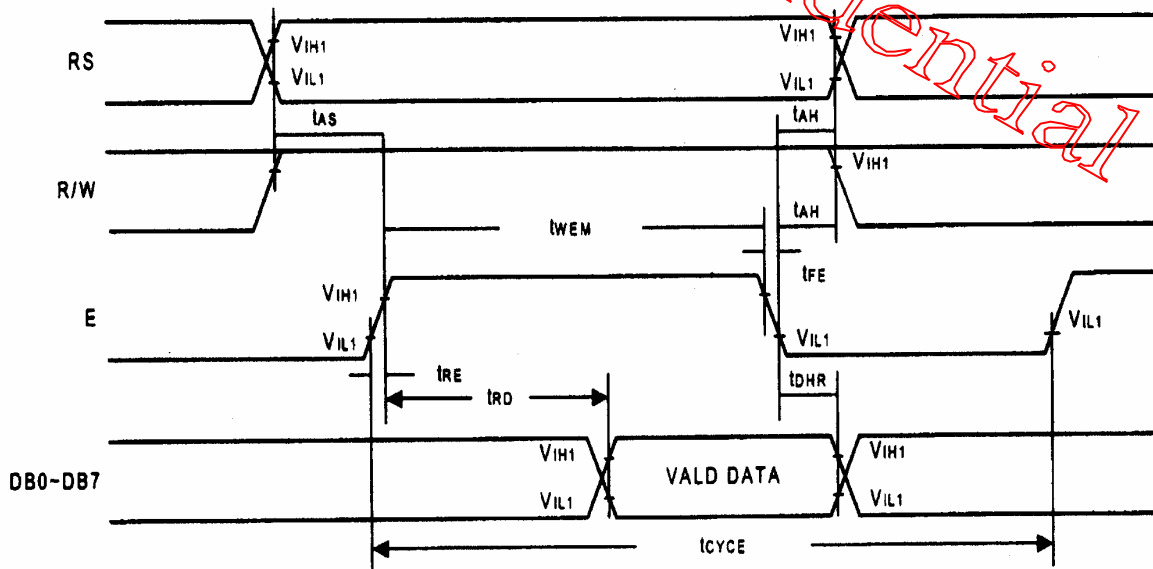

Figure 1. Bus Read Operation Sequence

Write Cycle ($T_a=25^\circ\text{C}$, $V_{dd}=5\text{V}$)

Symbol	Parameter	Min	Typ	Max	Unit	Conditions
t_{CYCE}	Enable Cycle Time	500	—	—	ns	Figure 2
t_{WEM}	Enable “H” Level Pulse Width	300	—	—	ns	Figure 2
$t_{\text{RE}}, t_{\text{FE}}$	Enable Rise/Fall Time	—	—	25	ns	Figure 2
t_{AS}	RS, R/W Setup Time	60	—	—	ns	Figure 2
t_{AH}	RS, R/W Address Hold Time	10	—	—	ns	Figure 2
t_{RD}	Data Output Delay	100	—	—	ns	Figure 2
t_{DHW}	Data Hold Time	10	—	—	ns	Figure 2

Write Operation

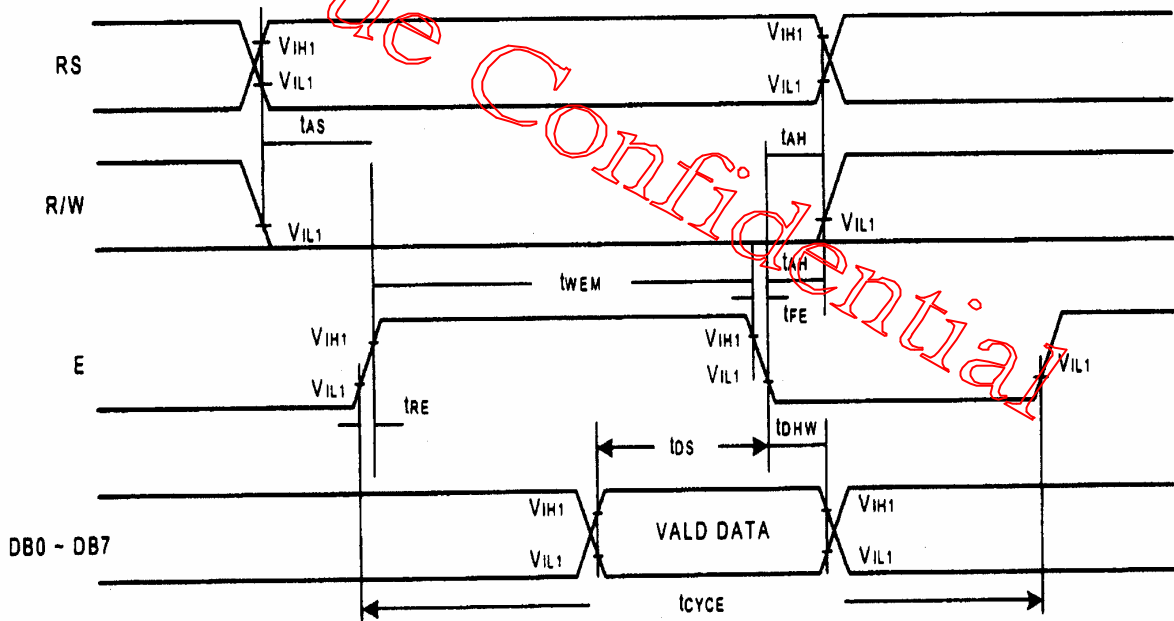

Figure 2. Bus Write Operation Sequence

Timing Characteristics of Interface Signals with Segment Driver

($T_a=25^{\circ}\text{C}$, $V_{dd}=5\text{V}$)

Symbol	Parameter	Min	Typ	Max	Unit	Conditions
t_{cWH}	Clock Pulse Width High	800	—	—	ns	Figure 3
t_{cWL}	Clock Pulse Width Low	800	—	—	ns	Figure 3
t_{sU}	Data Setup Time	300	—	—	ns	Figure 3
t_{dH}	Data Hold Time	300	—	—	ns	Figure 3
t_{cSU}	Clock Setup Time	500	—	—	ns	Figure 3
t_{dM}	M Delay Time	-1000	—	1000	ns	Figure 3

Timing Waveforms (continued)

Interface Signals with Segment Driver

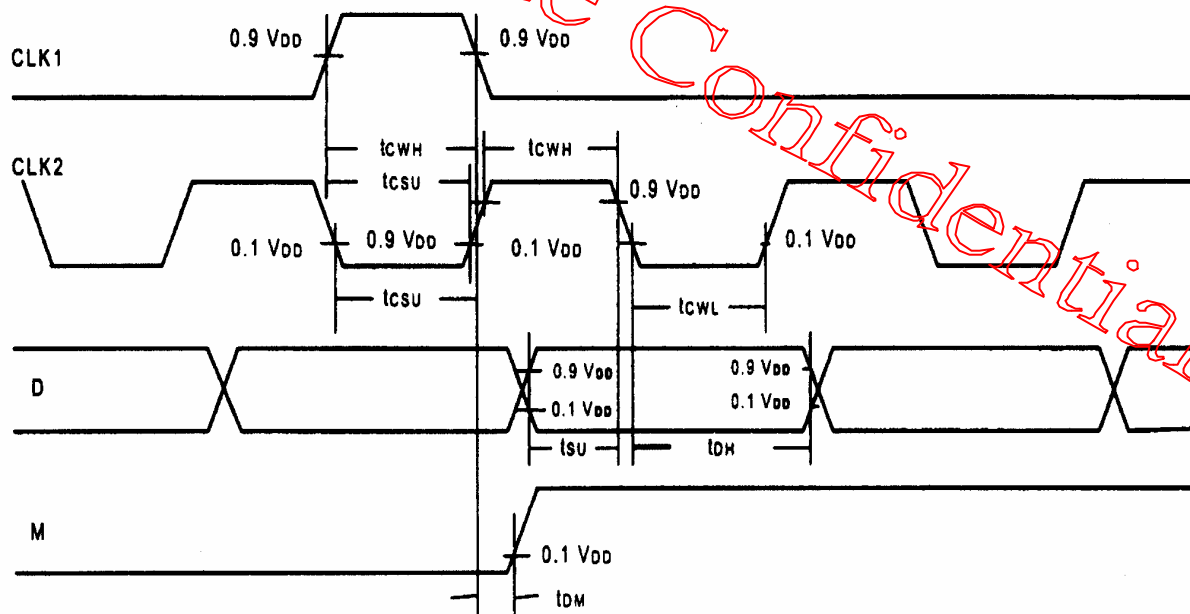

Figure 3. Sending Data to Segment Driver

Power Supply Conditions Using Internal Reset Circuit

Symbol	Parameter	Min	Typ	Max	Unit	Conditions
t_{RON}	Clock Pulse Width High	0.1	—	10	ms	Figure 4
t_{OFF}	Clock Pulse Width Low	1	—	—	ms	Figure 4

Interface Signals with Segment Driver

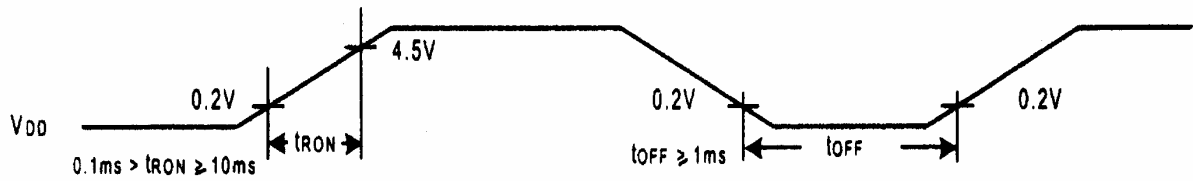

Figure 4. t_{OFF} stipulates the time of power OFF for instantaneous power supply to or when power supply repeats ON and OFF.

Picvue Confidential

8.2 COMMAND

Instruction Set

Instruction	Code										Function	Execution time (max) ($f_{osc} = 250\text{KHz}$)		
	RS	RW	DB7	DB6	DB5	DB4	DB3	DB2	DB1	DB0				
Display Clear	0	0	0	0	0	0	0	0	0	0	1	Clear entire display area, restore display from shift, and load address counter with DD RAM address 00H.	1.64ms	
Display/ Cursor Home	0	0	0	0	0	0	0	0	0	1	*	Restore display from shift and load address counter with DD RAM address 00H.	1.64ms	
Entry Mode Set	0	0	0	0	0	0	0	0	1	I/D	S	Specify direction of cursor movement and display shift mode. This operation takes place after each data transfer (read/write).	40 μ s	
Display ON/OFF	0	0	0	0	0	0	0	1	D	C	B	Specify activation of display (D) cursor (C) and blinking of character at cursor position (B).	40 μ s	
Display/ Cursor Shift	0	0	0	0	0	0	1	S/C	R/L	*	*	Shift display or move cursor.	40 μ s	
Function Set	0	0	0	0	1	DL	N	F	*	*	*	Set interface data length (DL), number of display line (N), and character font (F).	40 μ s	
RAM Address Set	0	0	0	1	ACG							Load the address counter with a CG RAM address. Subsequent data access is for CG RAM data.	40 μ s	
DD RAM Address Set	0	0	1	ADD							Load the address counter with a DD RAM address. Subsequent data access is for DD RAM data.	40 μ s		
Busy Flag/ Address Counter Read	0	1	BF	AC							Read Busy Flag (BF) and contents of Address Counter (AC).	40 μ s		
CG RAM/ DD RAM Data Write	1	0	Write data							Write data to CG RAM or DD RAM.	40 μ s			
CG RAM/ DD RAM Data Read	1	1	Read data							Read data from CG RAM or DD RAM.	40 μ s			
	I/D = 1 : Increment S = 1 : Display Shift On D = 1 : Display On C = 1 : Cursor Display On B = 1 : Cursor Blink On S/C = 1 : Shift Display R/L = 1 : Shift Right DL = 1 : 8-Bit N = 1 : Dual Line F = 1 : 5x10 dots BF = 1 : Internal Operation BF = 1 : Ready for Instruction										I/D = 0 : Decrement S/C = 0 : Move Cursor R/L = 0 : Shift Left DL = 0 : 4-Bit N = 0 : Signal Line F = 0 : 5x8 dots		DD RAM : Display Data RAM CG RAM : Character Generator RAM ACG : Character Generator RAM Address ADD : Display Data RAM Address AC : Address Counter	

Note 1: Symbol "*" signifies an insignificant bit (disregard).

Note 2: Correct input value for "N" is predetermined for each model.

		Higher 4-bit (D4 to D7) of Character Code (Hexadecimal)															
		0	1	2	3	4	5	6	7	8	9	A	B	C	D	E	F
0	CG RAM (1)			0	1	P	'	P					ー	夕	ミ	α	P
1	CG RAM (2)		!	1	A	Q	a	9				。	ア	チ	△	△	9
2	CG RAM (3)		"	2	B	R	b	r				「	イ	ツ	×	β	θ
3	CG RAM (4)		#	3	C	S	c	≡				」	ウ	テ	モ	ε	ω
4	CG RAM (5)		\$	4	D	T	d	t				、	エ	ト	ヤ	μ	Ω
5	CG RAM (6)		%	5	E	U	e	u				。	オ	ナ	1	ε	Ω
6	CG RAM (7)		&	6	F	V	f	v				ヲ	カ	ニ	ヨ	P	Σ
7	CG RAM (8)		'	7	G	W	g	w				ア	キ	ヌ	ラ	g	π
8	CG RAM (1)		(8	H	X	h	x				イ	ク	ネ	リ	γ	Σ
9	CG RAM (2))	9	I	Y	i	y				ウ	ケ	ル	ル	γ	γ
A	CG RAM (3)		*	:	J	Z	j	z				エ	コ	ン	レ	j	γ
B	CG RAM (4)		+	:	K	[k	[オ	サ	ヒ	ロ	*	π
C	CG RAM (5)		,	%	L	¥	l	l				ヤ	シ	フ	ワ	φ	π
D	CG RAM (6)		-	≡	M	∫	m	∫				ユ	ヌ	ン	ン	π	÷
E	CG RAM (7)		.	>	N	∫	n	∫				ヨ	セ	ホ	°	π	
F	CG RAM (8)		/	?	O	_	o	+				ッ	ソ	マ	°	π	■

Confidential

9.0 SPECIFICATIONS OF LED BACKLIGHT:

ITEM	SYMBOL	MIN	TYPE	MAX	UNITS	TEST CONDITION
Supply Current	I		170		mA	V= 4.2V
Supply voltage	V	4.0	4.2	4.5	V	
Luminous intensity	I _v		100		Cd/m ²	IF= 170 mA
Peak Emission wavelength	λ		565		nm	IF=170 mA
Spectrum radiation Bandwidth			30		nm	IF= 170 mA
Reverse Current	I _R			1.2	mA	VR = 5V
Color	Yellow / Green					

Picvue Confidential

10.0 MAXIMUM ABSOLUTE VALUES

ITEM	SYMBOL	MIN	MAX	UNITS
Operating temperature	T _{OP}	0	50	
Storage temperature	T _{ST}	-20	70	
Supply voltage for logic	V _{DD} - V _{SS}	-0.3	7.0	V
Supply voltage for LCD driving	V _{DD} - V _O	-0.3	6.5	
Logic input voltage	V _I	V _{SS} - 0.3	V _{DD} + 0.3	

11.0 RELIABILITY

ITEM	CONDITIONS	CRITERIA
High temperature operation	50 °C for 200 hours	<ul style="list-style-type: none"> ◆ No defect in cosmetic and operational functions. ◆ Total current consumption below double of initial value.
Low temperature operation	0 °C for 200 hours	
High humidity storage	40 °C, 90 % RH for 240 hours	
High temperature storage	70 °C for 200 hours	
Low temperature storage	-20 °C for 200 hours	
Temperature cycling	-20 °C (30 min) ↓↑ 25 °C (5 min) ↓↑ 60 °C (30 min) CYCLES: 10	
Vibration	Random Wave: 40~500 Hz Acceleration: 5g Each Direction (x, y, z): 50 sec	

Picvue Confidential

12.0 COSMETIC CRITERIA OF LCD SCREEN

DEFECT	JUDGMENT CRITERION		
Spots	Size d (mm)	Acceptable quantity in active area	
	$d \leq 0.1$	Disregard	
	$0.1 < d \leq 0.2$	6	
	$0.2 < d \leq 0.3$	2	
	$d > 0.3$	0	
Note: $d = (\text{Length} + \text{Width})/2$			
Polarizer Bubbles	Size d (mm)	Acceptable quantity in active area	
	$d \leq 0.3$	Disregard	
	$0.3 < d \leq 1.0$	3	
	$1.0 < d \leq 1.5$	1	
	$d > 1.5$	0	
Note: $d = (\text{Length} + \text{Width})/2$			
Lines	Width W (mm)	Acceptable quantity in active area	
	Length L (mm)		
	$W \leq 0.02$	Disregard	
	$0.02 < W \leq 0.05$	$L \leq 5.0$	6
		$L > 5.0$	0
	$0.05 < W \leq 0.1$	$L \leq 2.0$	6
		$L > 2.0$	0
$W > 0.1$	See criteria for Spots		
Testing conditions: 20W fluorescent lamp at 30 cm distance at normal viewing angle			

13.0 PRECAUTIONS

13.1 Static charge

Since this LCD module contains CMOS LSIs that are sensitive to static charge, care must be taken when handling it.

13.2 Power on sequence

1. Input signals should not be applied to the LCD module before the logic system voltage has reached the specified voltage. If the above sequence is not kept the LCD module might be permanently damaged.
2. When connecting the power supply, connect the LCD bias voltage *after* connecting the logic system voltage.
3. When disconnecting the power supply, disconnect the logic system voltage *after* the LCD bias voltage.
4. It is recommended to connect a serial resistor or fuse to the LCD bias power supply of the system, as a current limiter. The value of the resistor depends on the kind of LCD used, but is typically 50 ~ 100 Ω .

13.3 Operation

1. It is essential to drive the LCD within the specified voltage limits, since a higher driving voltage than allowed causes a shorter LCD lifetime. Under these circumstances, electrochemical reactions will result in undesirable deterioration of the LCD.
2. The response time of the LC fluid is considerably longer at low temperatures than in the normal operating temperature range. On the other hand, the LCD will show a dark blue color at high temperatures. Those phenomena do not indicate a malfunction or defect of the LCD. Back at normal temperatures, the LCD will return to its original behavior.
3. If the display area is pressed hard during operation, some abnormal display patterns might appear. However, the display will resume normal operation after turning the module off and on.
4. Moisture on the terminals could cause an electrochemical reaction resulting in an open terminal connection. If the environmental temperature is higher than 40 °C, it is required that the relative humidity is 50% or less.

13.4 Packaging

1. Do not leave the product in a place of high humidity for a long period. For storage in a location where the temperature is 35 °C or higher, special care to protect the product from high humidity is required. A combination of high temperature and high humidity may cause polarization degradation and damage as well. Please keep the temperature and humidity within the specified range for storing.

2. Since LCD panels tend to be easily damaged, they should be handled with full care. Avoid any contact with materials that have a hardness of more than 2H.
3. Adhesives used for adhering upper/lower polarizers and aluminum plates are made of organic substances that will deteriorate by chemical reactions with for example chemicals such as acetone, toluene, ethanol, and isopropylalcohol. Please prevent the use of these chemicals and contact us when it is necessary for you to use other chemicals.
4. Immediately wipe off saliva or water drops from the display area with an absorbent cotton cloth, without scrubbing it. If adhered for a long period, such particles might cause deformation or faded color.
5. Moisture deposited on the display surface and contact terminals due to low temperatures will be a cause for polarizer damage, stains, and dirt. Before use, such panels should be slowly warmed up to a temperature that is higher than room temperature.
6. Touching the display area and contact terminals with bare hands is harmful to polarizer and may lead to poor insulation at the terminals.
7. The glass is fragile and can be cracked or chipped easily by handling, in particular on near its edge. Please prevent sudden shocks or exposing the glass to other sorts of stress.

13.5 Long-term storage

For long-term storage the following methods are highly recommended:

1. Store the product in a polyethylene bag with a sealed opening to prevent fresh air entering from the outside. Placing it with a desiccant is not necessary.
2. Store the product in a dark place, with the temperature in the range from 0 to 35 .
3. Keep the sensitive polarizer surface of the LCD panels clear of any contact. We recommend using the container that was used by Picvue to deliver the products.

13.6 Cleaning of the product

To clean the product make sure to use absorbent cotton cloth or other soft material like chamois. Make sure to rub it gently, and do not use chemicals when cleaning.

14.0 FINAL REMARKS

1. The above specifications are the binding criteria for Picvue's outgoing quality inspection.
2. The customer is kindly requested to inform Picvue as soon as possible on any questions, remarks, and disagreements regarding these specifications.
3. Picvue is not responsible for damage to its products due to neglect of the precautions as described in the previous chapter.

APPENDIX—

REVISION RECORD

REV	REVISION ITEM	DATE
NEW	—	2000/6/15
A		
B		
C		
D		
E		
F		
G		
H		
I		
J		
K		
L		
M		
N		

Picvue Confidential