



# PJP7N60 / PJF7N60

## 600V N-Channel Enhancement Mode MOSFET

## TO-220AB / ITO-220AB

### FEATURES

- 7A , 600V,  $R_{DS(ON)}=1.2\Omega@V_{GS}=10V, I_D=3.5A$
- Low ON Resistance
- Fast Switching
- Low Gate Charge
- Fully Characterized Avalanche Voltage and Current
- Specially Designed for AC Adapter, Battery Charge and SMPS
- In compliance with EU RoHs 2002/95/EC Directives

### MECHANICAL DATA

- Case: TO-220AB / ITO-220AB Molded Plastic
- Terminals : Solderable per MIL-STD-750,Method 2026

### ORDERING INFORMATION

TYPE	MARKING	PACKAGE	PACKING
PJP7N60	P7N60	TO-220AB	50PCS/TUBE
PJF7N60	F7N60	ITO-220AB	50PCS/TUBE

TO-220AB

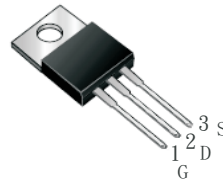

ITO-220AB

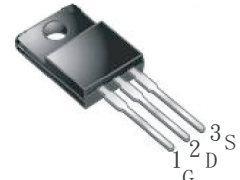

### INTERNAL SCHEMATIC DIAGRAM

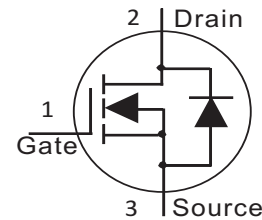

### Maximum RATINGS and Thermal Characteristics ( $T_A=25^\circ\text{C}$ unless otherwise noted )

PARAMETER	Symbol	PJP7N60	PJF7N60	Units
Drain-Source Voltage	$V_{DS}$	600		V
Gate-Source Voltage	$V_{GS}$	$\pm 30$		V
Continuous Drain Current	$I_D$	7	7	A
Pulsed Drain Current <sup>1)</sup>	$I_{DM}$	28	28	A
Maximum Power Dissipation Derating Factor	$P_D$	125 1.0	45 0.36	W
Operating Junction and Storage Temperature Range	$T_J, T_{STG}$	-55 to +150		$^\circ\text{C}$
Avalanche Energy with Single Pulse $I_{AS}=7.0A, V_{DD}=50V, L=19.5mH$	$E_{AS}$	530		mJ
Junction-to-Case Thermal Resistance	$R_{\theta JC}$	1	2.78	$^\circ\text{C/W}$
Junction-to Ambient Thermal Resistance	$R_{\theta JA}$	62.5	100	$^\circ\text{C/W}$

**Note** : 1. Maximum DC current limited by the package

PAN JIT RESERVES THE RIGHT TO IMPROVE PRODUCT DESIGN,FUNCTIONS AND RELIABILITY WITHOUT NOTICE



# PJP7N60 / PJF7N60

## ELECTRICAL CHARACTERISTICS (T<sub>A</sub>=25°C unless otherwise noted)

Parameter	Symbol	Test Condition	Min.	Typ.	Max.	Units
<b>Static</b>						
Drain-Source Breakdown Voltage	BV <sub>DSS</sub>	V <sub>GS</sub> =0V, I <sub>D</sub> =250μA	600	-	-	V
Gate Threshold Voltage	V <sub>GS(th)</sub>	V <sub>DS</sub> =V <sub>GS</sub> , I <sub>D</sub> =250μA	2.0	-	4.0	V
Drain-Source On-State Resistance	R <sub>DS(on)</sub>	V <sub>GS</sub> =10V, I <sub>D</sub> =3.5A	-	0.96	1.2	Ω
Zero Gate Voltage Drain Current	I <sub>DSS</sub>	V <sub>DS</sub> =600V, V <sub>GS</sub> =0V	-	-	10	μA
Gate Body Leakage	I <sub>GSS</sub>	V <sub>GS</sub> =±30V, V <sub>DS</sub> =0V	-	-	±100	nA
<b>Dynamic</b>						
Total Gate Charge	Q <sub>g</sub>	V <sub>DS</sub> =480V, I <sub>D</sub> =7A V <sub>GS</sub> =10V	-	19.8	-	nC
Gate-Source Charge	Q <sub>gs</sub>		-	5.8	-	
Gate-Drain Charge	Q <sub>gd</sub>		-	8.2	-	
Turn-On Delay Time	t <sub>d(on)</sub>	V <sub>DD</sub> =300V, I <sub>D</sub> =7A V <sub>GS</sub> =10V, R <sub>G</sub> =25Ω	-	13.2	18	ns
Turn-On Rise Time	t <sub>r</sub>		-	16.4	26	
Turn-Off Delay Time	t <sub>d(off)</sub>		-	40.8	58	
Turn-Off Fall Time	t <sub>f</sub>		-	21.6	32	
Input Capacitance	C <sub>iss</sub>	V <sub>DS</sub> =25V, V <sub>GS</sub> =0V f=1.0MHz	-	1152	1480	pF
Output Capacitance	C <sub>oss</sub>		-	110	160	
Reverse Transfer Capacitance	C <sub>rss</sub>		-	10	18	
<b>Source-Drain Diode</b>						
Max. Diode Forward Current	I <sub>S</sub>	-	-	-	7.0	A
Max.Pulsed Source Current	I <sub>SM</sub>	-	-	-	28	A
Diode Forward Voltage	V <sub>SD</sub>	I <sub>S</sub> =7A, V <sub>GS</sub> =0V	-	-	1.4	V
Reverse Recovery Time	t <sub>rr</sub>	V <sub>GS</sub> =0V, I <sub>F</sub> =7A di/dt=100A/us	-	365	-	ns
Reverse Recovery Charge	Q <sub>rr</sub>		-	3.4	-	μC

**NOTE** : Plus Test : Pluse Width ≤ 300us, Duty Cycle ≤ 2%.



# PJP7N60 / PJF7N60

Typical Characteristics Curves (  $T_a=25^\circ\text{C}$ , unless otherwise noted)

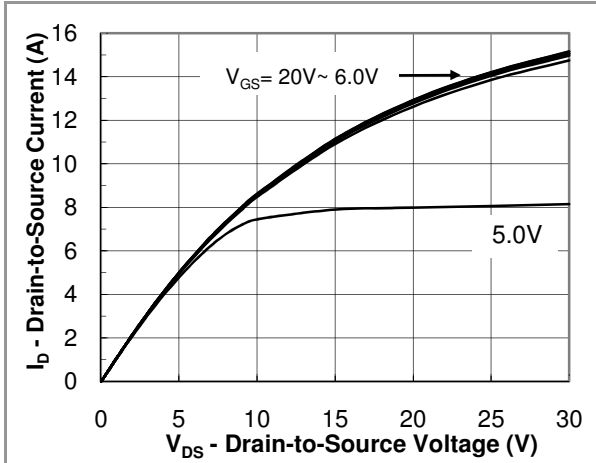

Fig.1 Output Characteristic

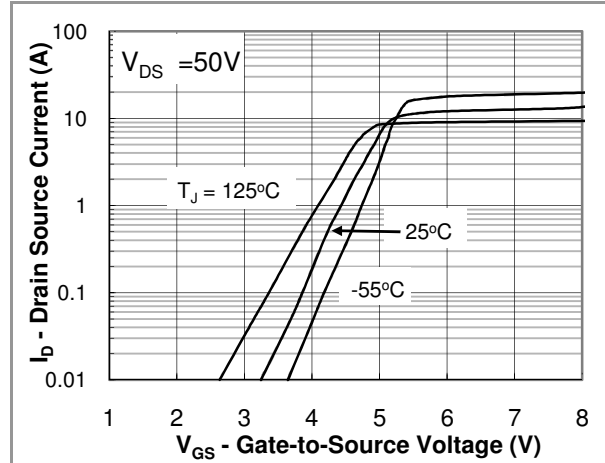

Fig.2 Transfer Characteristic

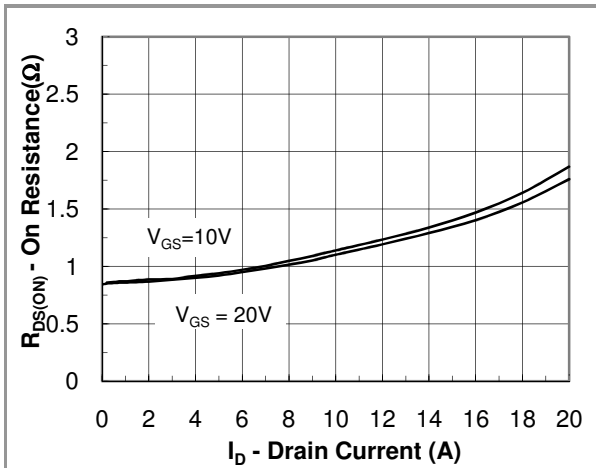

Fig.3 On Resistance vs Drain Current

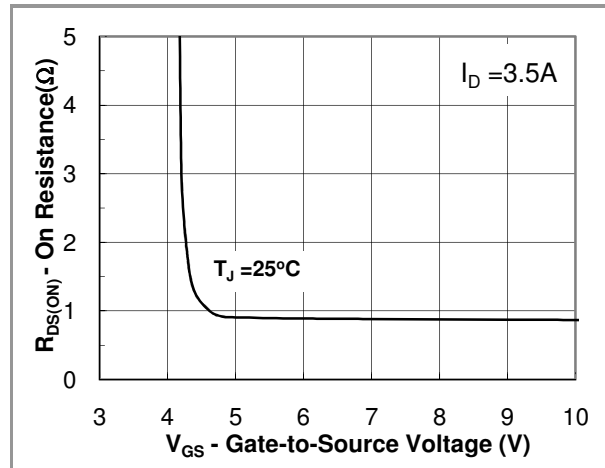

Fig.4 On Resistance vs Gate to Source Voltage

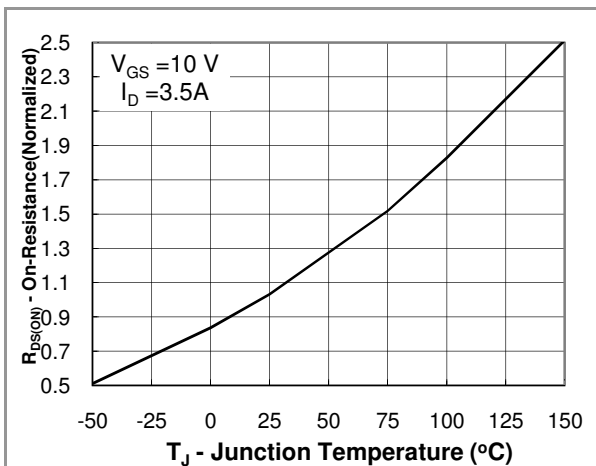

Fig.5 On Resistance vs Junction Temperature

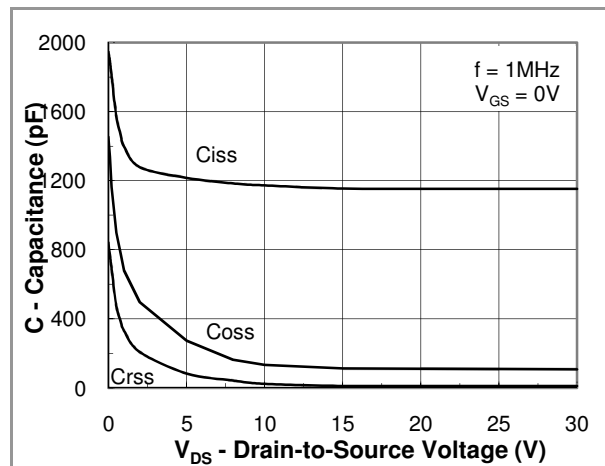

Fig.6 Capacitance



# PJP7N60 / PJF7N60

Typical Characteristics Curves (  $T_a=25^\circ\text{C}$ , unless otherwise noted)

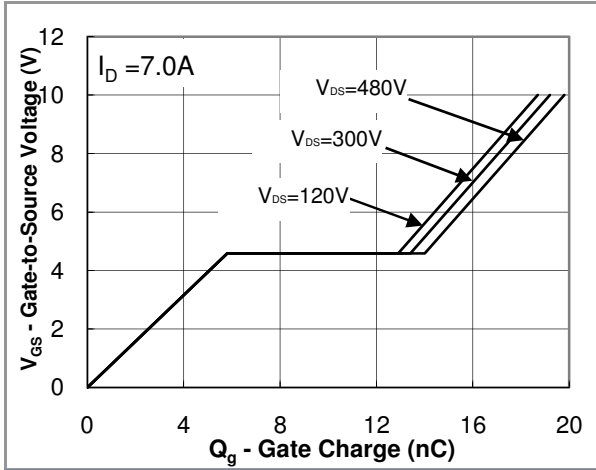

Fig. 7 Gate Charge Waveform

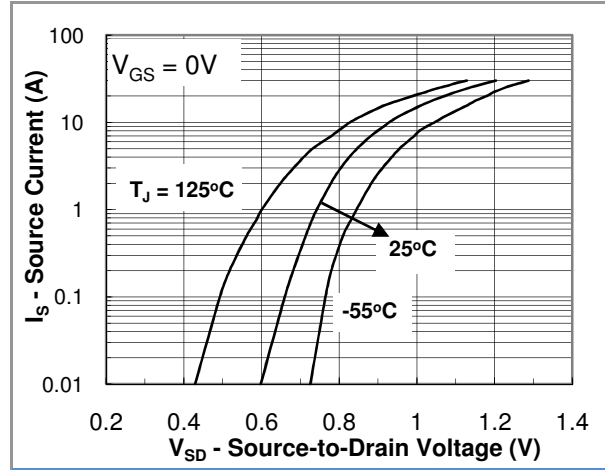

Fig.8 Source-Drain Diode Forward Voltage

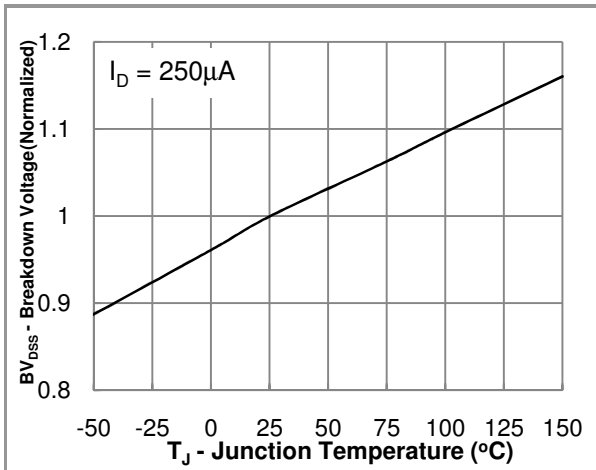

Fig.9 Breakdown Voltage vs Junction Temperature



## PJP7N60 / PJF7N60

---

### LEGALSTATEMENT

#### **Copyright PanJit International, Inc 2010**

The information presented in this document is believed to be accurate and reliable. The specifications and information herein are subject to change without notice. Pan Jit makes no warranty, representation or guarantee regarding the suitability of its products for any particular purpose. Pan Jit products are not authorized for use in life support devices or systems. Pan Jit does not convey any license under its patent rights or rights of others.