

ILD4035

350 mA LED Driver

ILD4035

Data Sheet

Revision 1.0, 2010-11-11

Edition 2010-11-11

**Published by
Infineon Technologies AG
81726 Munich, Germany**

**© 2010 Infineon Technologies AG
All Rights Reserved.**

Legal Disclaimer

The information given in this document shall in no event be regarded as a guarantee of conditions or characteristics. With respect to any examples or hints given herein, any typical values stated herein and/or any information regarding the application of the device, Infineon Technologies hereby disclaims any and all warranties and liabilities of any kind, including without limitation, warranties of non-infringement of intellectual property rights of any third party.

Information

For further information on technology, delivery terms and conditions and prices, please contact the nearest Infineon Technologies Office (www.infineon.com).

Warnings

Due to technical requirements, components may contain dangerous substances. For information on the types in question, please contact the nearest Infineon Technologies Office.

Infineon Technologies components may be used in life-support devices or systems only with the express written approval of Infineon Technologies, if a failure of such components can reasonably be expected to cause the failure of that life-support device or system or to affect the safety or effectiveness of that device or system. Life support devices or systems are intended to be implanted in the human body or to support and/or maintain and sustain and/or protect human life. If they fail, it is reasonable to assume that the health of the user or other persons may be endangered.

Revision History

Page or Item	Subjects (major changes since previous revision)
Revision 1.0, 2010-11-11	
<Revision X.Y>, <yyyy-mm-dd>	

Trademarks of Infineon Technologies AG

AURIX™, BlueMoon™, C166™, CanPAK™, CIPOS™, CIPURSE™, COMNEON™, EconoPACK™, CoolMOS™, CoolSET™, CORECONTROL™, CROSSAVE™, DAVE™, EasyPIM™, EconoBRIDGE™, EconoDUAL™, EconoPIM™, EiceDRIVER™, eupec™, FCOS™, HITFET™, HybridPACK™, I²RF™, ISOFACE™, IsoPACK™, MIPAQ™, ModSTACK™, my-d™, NovalithIC™, OmniTune™, OptiMOS™, ORIGA™, PRIMARION™, PrimePACK™, PrimeSTACK™, PRO-SIL™, PROFET™, RASIC™, ReverSave™, SatRIC™, SIEGET™, SINDRION™, SIPMOS™, SMARTi™, SmartLEWIS™, SOLID FLASH™, TEMPFET™, thinQ!™, TRENCHSTOP™, TriCore™, X-GOLD™, X-PMU™, XMM™, XPOSYS™.

Other Trademarks

Advance Design System™ (ADS) of Agilent Technologies, AMBA™, ARM™, MULTI-ICE™, KEIL™, PRIMECELL™, REALVIEW™, THUMB™, μVision™ of ARM Limited, UK. AUTOSAR™ is licensed by AUTOSAR development partnership. Bluetooth™ of Bluetooth SIG Inc. CAT-ig™ of DECT Forum. COLOSSUS™, FirstGPS™ of Trimble Navigation Ltd. EMV™ of EMVCo, LLC (Visa Holdings Inc.). EPCOS™ of Epcos AG. FLEXGO™ of Microsoft Corporation. FlexRay™ is licensed by FlexRay Consortium. HYPERTERMINAL™ of Hilgraeve Incorporated. IEC™ of Commission Electrotechnique Internationale. IrDA™ of Infrared Data Association Corporation. ISO™ of INTERNATIONAL ORGANIZATION FOR STANDARDIZATION. MATLAB™ of MathWorks, Inc. MAXIM™ of Maxim Integrated Products, Inc. MICROTEC™, NUCLEUS™ of Mentor Graphics Corporation. Mifare™ of NXP. MIPI™ of MIPI Alliance, Inc. MIPS™ of MIPS Technologies, Inc., USA. muRata™ of MURATA MANUFACTURING CO., MICROWAVE OFFICE™ (MWO) of Applied Wave Research Inc., OmniVision™ of OmniVision Technologies, Inc. Openwave™ Openwave Systems Inc. RED HAT™ Red Hat, Inc. RFMD™ RF Micro Devices, Inc. SIRIUS™ of Sirius Satellite Radio Inc. SOLARIS™ of Sun Microsystems, Inc. SPANSION™ of Spansion LLC Ltd. Symbian™ of Symbian Software Limited. TAIYO YUDEN™ of Taiyo Yuden Co. TEAKLITE™ of CEVA, Inc. TEKTRONIX™ of Tektronix Inc. TOKO™ of TOKO KABUSHIKI KAISHA TA. UNIX™ of X/Open Company Limited. VERILOG™, PALLADIUM™ of Cadence Design Systems, Inc. VLYNQ™ of Texas Instruments Incorporated. VXWORKS™, WIND RIVER™ of WIND RIVER SYSTEMS, INC. ZETEX™ of Diodes Zetex Limited.

Last Trademarks Update 2010-10-26

Table of Contents

	Table of Contents	4
	List of Figures	5
	List of Tables	6
1	Features	7
2	Applications	7
3	Product Brief	8
4	Electrical Characteristics	12
4.1	DC Characteristics	12
4.2	AC Characteristics	13
4.3	Digital Signals	13
5	Basic Application Information	14
5.1	Setting the average LED current	14
5.2	Dimming of the LEDs	14
5.3	Temperature Characteristics of the ILD4035 Demo Board	17
5.4	AC- Parameter	18
6	Application Circuit	27
7	Evaluation Board	28
8	Package Information SC74-6-4	28

List of Figures

Figure 1	Block Diagram	8
Figure 2	ILD4035; Total Power Dissipation	10
Figure 3	ILD4035; Safe Operating Area	10
Figure 4	ILD4035; Rsense Calculation	14
Figure 5	ILD4035; Analog Voltage Dimming	15
Figure 6	ILD4035; Analog Voltage Dimming with Different Rsense	15
Figure 7	ILD4035; PWM Dimming	16
Figure 8	ILD4035; Application Circuit	27
Figure 9	ILD4035; Evaluation- Board	28
Figure 10	Package Outline	28
Figure 11	Tape Dimensions	28

List of Tables

Table 1	Pin Definition and Function	9
Table 2	Maximum Ratings	9
Table 3	Maximum Thermal Resistance	9
Table 4	DC Characteristics at $T_A = 25\text{ }^\circ\text{C}$	12
Table 5	AC Characteristics at $T_A = 25\text{ }^\circ\text{C}$	13
Table 6	AC Characteristics, $V_{CE} = 3\text{ V}$, $f = 150\text{ MHz}$	13
Table 7	Percentage of Max. LED Current vs. DC Voltage at Pin 3	15

350 mA LED Driver with Internal Switch ILD4035

1 Features

- Wide input voltage range: 4.5 V ... 42 V
- Internal switch
- 350 mA LED output current
- Over current protection
- Over voltage protection
- Reversible temperature shut down mechanism
- Inherent open- circuit LED protection
- Soft- start capability
- Low shut down current < 100 nA in operating voltage range
- Analog voltage and PWM dimming possible
- Typical 3% output current accuracy
- Very low LED current drift over temperature
- Minimum external components required
- Small Package: SC74

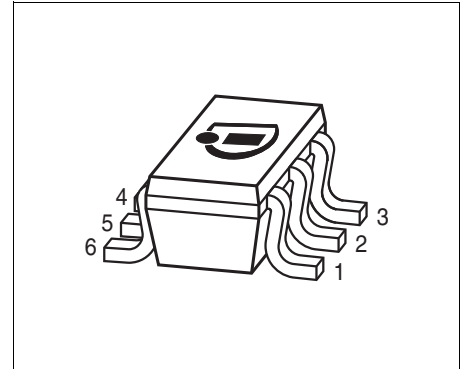

2 Applications

- LED Driver for general lighting applications
- Indoor illumination, residential lighting
- Outdoor illumination, street lighting
- Office lighting, downlights
- Architectural lighting

Product Name	Package	Pin Configuration				Marking
ILD4035	SC74-6-4					35

3 Product Brief

The ILD4035 is a hysteretic Step down LED converter IC for general lighting applications, which is capable to drive high power LEDs with currents up to 350 mA.

The IC incorporates a wide input voltage range and an internal power switch. The output current level can be adjusted with an external sense resistor.

According to the multifunctional control pin the IC can be switched on and off by an external signal, which is also suitable to regulate brightness of the LEDs by PWM or analog voltage dimming.

Depending on the value of the switching inductor the switching frequency and the voltage ripple can be set.

The precise internal bandgap stabilizes the circuit and provides stable current conditions over temperature range.

To ensure a long lifetime of the LED system, the ILD4035 incorporates an overvoltage and an overcurrent protection.

In addition, the integrated thermal shutdown will protect the LEDs and the IC against thermal stress.

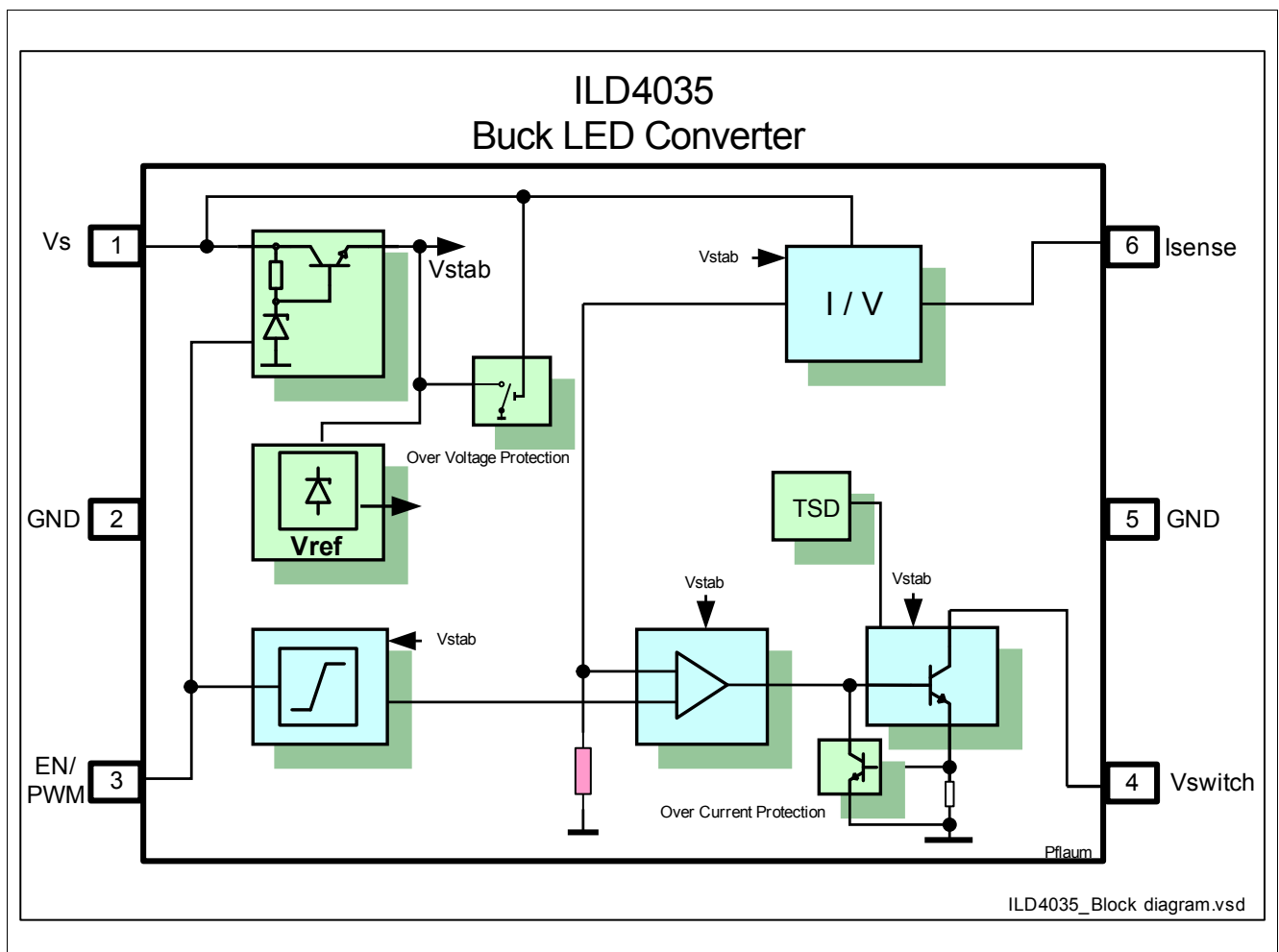

Figure 1 Block Diagram

Pin Definition
Table 1 Pin Definition and Function

Pin Number	Pin Symbol	Function
1	V_s	Supply Voltage
2	<i>GND</i>	IC ground
3	<i>EN / PWM</i>	Multifunctional Pin; Power On control voltage pin (<i>PWM input</i>)
4	V_{switch}	Power Switch Output
5	<i>GND</i>	IC ground
6	I_{sense}	LED current sense pin

Maximum Ratings
Table 2 Maximum Ratings

Parameter	Symbol	Limit Value	Unit
Supply voltage	V_s	45	V
Peak Output current	I_{out}	600	mA
Total Power Dissipation; $T_s = 85^\circ\text{C}$	P_{tot}	1000	mW
Junction temperature	T_J	125	$^\circ\text{C}$
Solder Temperature of GND pins	T_{SGND}	110	$^\circ\text{C}$
Storage temperature range	T_{STG}	-65... 150	$^\circ\text{C}$
ESD capability all pins ¹⁾	$V_{\text{ESD_HBM}}$	4	kV

1) Refer to HBM: JESD22 - A114

Thermal Resistance
Table 3 Maximum Thermal Resistance

Parameter	Symbol	Value	Unit
Junction - solder point	R_{thJS}	65	K/W

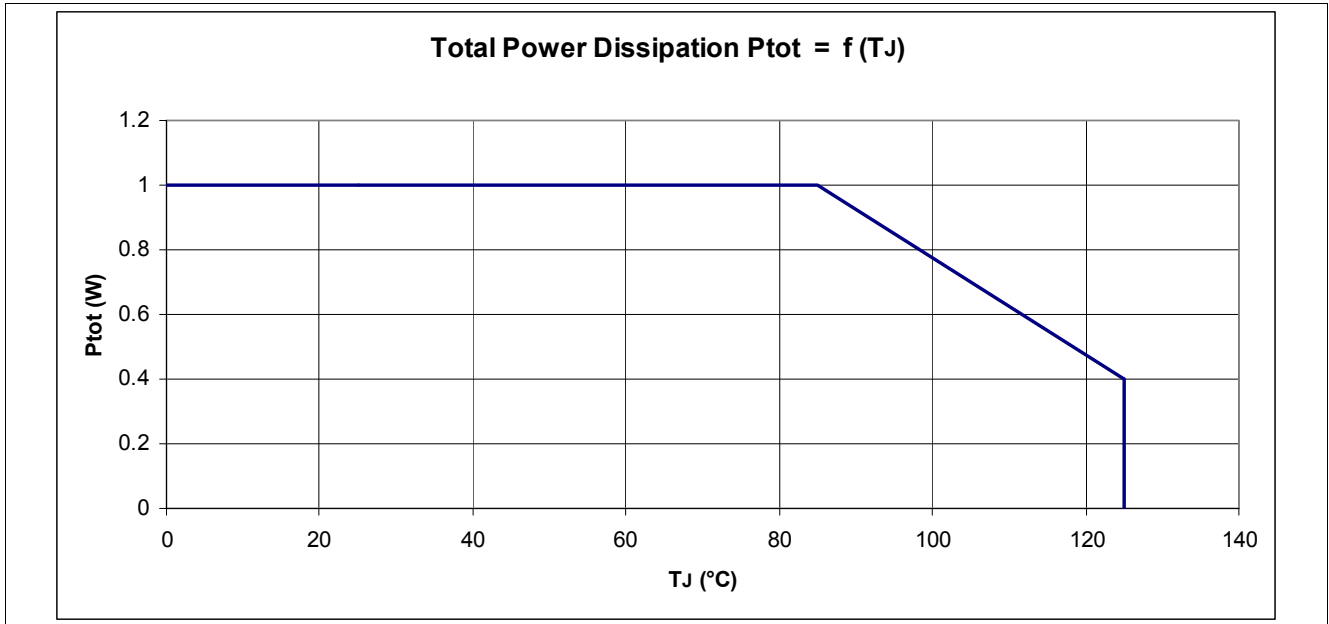

Figure 2 ILD4035; Total Power Dissipation

This formula is a first estimation to calculate the Power Dissipation of the IC

$$P_{tot} = 1.1 \text{ V} * I_{LED} * \text{duty cycle} + F_{OSC} * 1\mu\text{W} * I_{LED} / 350\text{mA} \quad (1)$$

For more precise analysis please measure T_s of ILD4035 at GND pin and use [Figure 2](#) as a reference.

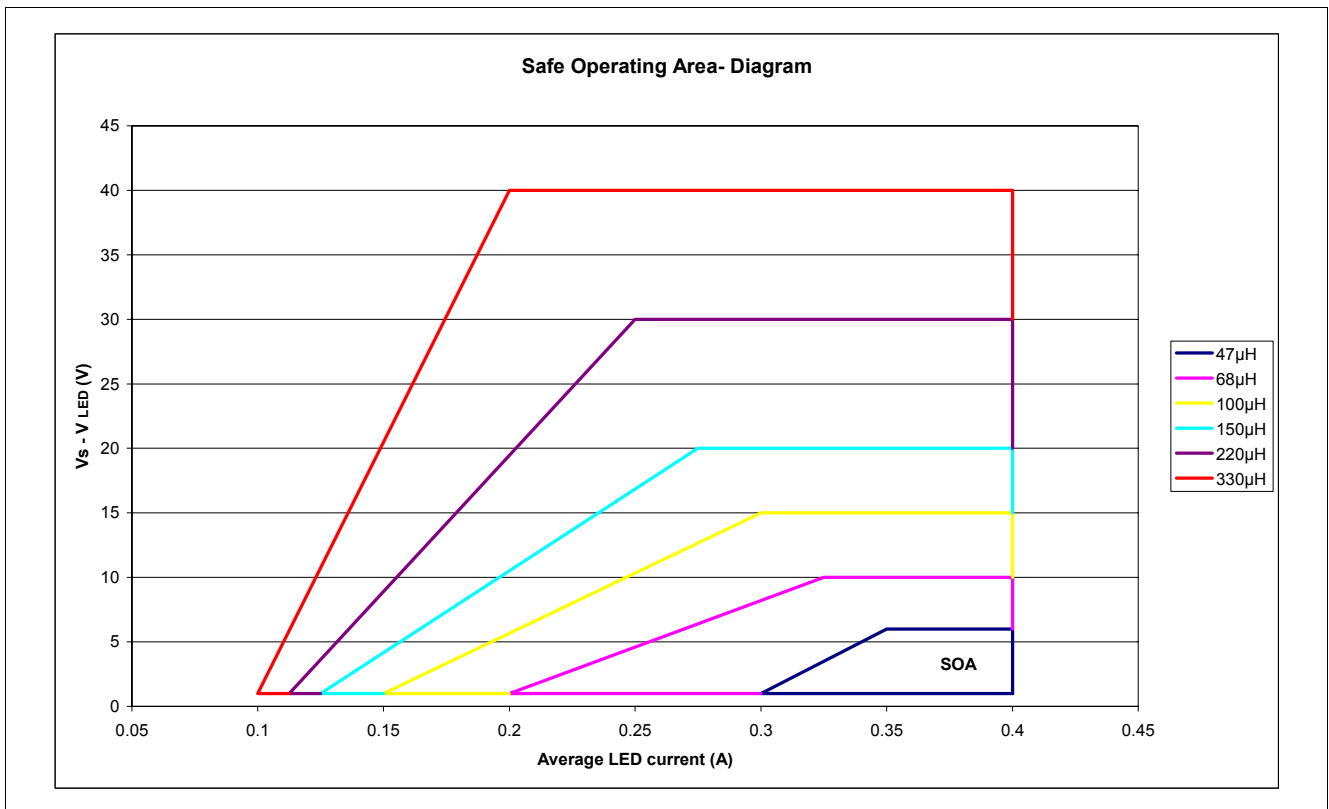

Figure 3 ILD4035; Safe Operating Area

This diagram shows the area of safe operation for the respective inductance values.

The safe area of operation consists of the minimum and maximum allowed average LED current and the resulting voltage overhead.

The voltage overhead is the difference between the sum of the LED forward voltages and the supply voltage.

Example Calculation 1

3 LEDs in series; $I_{LED} = 350 \text{ mA}$; $V_S = 12 \text{ V}$

$$V_{overhead} = V_S - V_{fLED} = 12 \text{ V} - 9 \text{ V} = 3 \text{ V}$$

=> every coil value could be used

Example Calculation 2

6 LEDs in series;

$$I_{LED} = 250 \text{ mA}; V_S = 24 \text{ V}$$

$$V_{overhead} = V_S - V_{fLED} = 24 \text{ V} - 18 \text{ V} = 6 \text{ V}$$

=> the coil values should be equal or above 100 μH

If $V_{overhead}$ is above the boundary of a certain coil value at wanted average LED current, the switching frequency and the associated power dissipation of the ILD4035 will increase beyond maximum ratings.

4 Electrical Characteristics

4.1 DC Characteristics

All voltages with respect to ground; positive; current flowing into pin; unless otherwise specified

All parameters have been measured at $T_{amb} = 25\text{ °C}$, unless otherwise specified.

$V_{en} = 3\text{ V}$

Table 4 DC Characteristics at $T_A = 25\text{ °C}$

Parameter	Symbol	Values			Unit	Note / Test Condition
		Min.	Typ.	Max.		
Supply voltage	V_S	4.5		42	V	
Overall current consumption open load	$I_{S_{open\ load}}$	2.1	2.7	3.5	mA	$V_S = 4.5\text{ V}$ $I_{LED} = 0\text{ mA}$
Overall current consumption open load	$I_{S_{open\ load}}$	2.7	3.5	4.3	mA	$V_S = 40\text{ V}$ $I_{LED} = 0\text{ mA}$
Overall current consumption open load	$I_{S_{open\ load}}$	2.0	8.4	13.0	mA	$V_S = 45\text{ V}$ $I_{LED} = 0\text{ mA}$
Overall standby current consumption	$I_{S_{standby}}$			1000	nA	$V_{en} = 0\text{ V}; V_S = 12\text{ V}$
Overall standby current consumption	$I_{S_{standby}}$			50	μA	$V_{en} = 0\text{ V}; V_S = 40\text{ V}$
Input Current of multifunctional control pin	I_{EN}		140	200	μA	$V_{en} = 3\text{ V}$ $V_S = 4.5..42\text{ V}$
Current of Sense input	I_{sense}		20		μA	At any LED current
Temperature shut down	$Th_{TSD}^{1)}$	85	90	95	$^{\circ}\text{C}$	$I_{out} \rightarrow 0\text{ A};$ value refers to T_S under condition $V_S = 12\text{ V}; 3\text{ LEDs}$ $L = 100\text{ }\mu\text{H};$ $R_{sense} = 333\text{ m}\Omega$

- 1) This specified value corresponds to solder temperature when the IC goes into shut down mode.
Operating ambient temperature depends on $R_{th_{SA}}$ of the PCB.

4.2 AC Characteristics

All parameters have been measured at $T_{amb} = 25\text{ °C}$, unless otherwise specified.

$$V_s = 12\text{ V}, V_{fLED} = 3\text{ V}$$

$$R_{sense} = 333\text{ m}\Omega \rightarrow I_{LED} = 350\text{ mA}$$

$$V_{en} = 3\text{ V}$$

$L = 100\text{ }\mu\text{H}$, unless otherwise specified

Table 5 AC Characteristics at $T_A = 25\text{ °C}$

Parameter	Symbol	Values			Unit	Note / Test Condition
		Min.	Typ.	Max.		
Mean current sense threshold voltage	ΔV_{sense}	115	118	121	mV	3 LEDs in series verified by sample test
Switching frequency	F_{sw}		180		kHz	3 LEDs in series
Maximum switching frequency	F_{swmax}		500		kHz	Recommended, depends on coil value
Sense threshold hysteresis	$V_{sensehys}$		+/- 7.5		%	Not subject to production test - verified by design/characteri-zation
Residual voltage at collector of power transistor	VCE		1.1		V	Internal power transistor is switched on
Output current accuracy	$I_{outaccVs}$		+/- 3		%	3 LEDs in series not subject to production test - verified by design/characteri-zation
Temperature drift of average LED current	$I_{driftTemp}$		+ 3		%	3 LEDs in series $T_J : 70 \rightarrow 110\text{ °C}$ not subject to production test - verified by design/characteri-zation

4.3 Digital Signals

All parameters have been measured at $T_{amb} = 25\text{ °C}$, unless otherwise specified.

Table 6 AC Characteristics, $V_{CE} = 3\text{ V}, f = 150\text{ MHz}$

Parameter	Symbol	Values			Unit	Note / Test Condition
		Min.	Typ.	Max.		
Multifunctional control pin voltage range	U_{Pon}	-0.3		42	V	
Control voltage for power on	U_{On}	2.2	2.5	42	V	Full LED current
Control voltage for power off	U_{Off}	-0.3		0.7	V	
Control voltage for analog dimming	U_{dim}	1		2.5	V	Linear dimming range

5 Basic Application Information

This section covers the basic information required for calculating the parameters for a certain LED application. For detailed application information please check the Application Note **AN215** (Driving 1 W LEDs with ILD4035) or visit our web site <http://www.infineon.com/led.appnotes>

5.1 Setting the average LED current

The average output current for the LEDs is set by the external sense resistor R_{sense} . To calculate the value of this resistor, a first approximation can be calculated using this formula.

The V_{sense} is dependent on the supply voltage V_s and the number of LEDs in series.

$$R_{sense} = \frac{V_{sense}}{I_{LED}}$$

Figure 4 ILD4035; Rsense Calculation

Example Calculation 1

$V_s = 12\text{ V}$, $V_{fLED} = 3\text{ V}$, 3 LEDs in series

=> $V_{sense} = 118\text{ mV}$

$I_{LED} = 350\text{ mA}$

=> $R_{sense} = 337\text{ m}\Omega$

Example Calculation 2

$V_s = 24\text{ V}$, $V_{fLED} = 3\text{ V}$, 6 LEDs in series

=> $V_{sense} = 100\text{ mV}$

$I_{LED} = 350\text{ mA}$

=> $R_{sense} = 286\text{ m}\Omega$

An easy way to achieve these resistor values is to connect standard resistors in parallel

5.2 Dimming of the LEDs

Typical operating conditions

All parameters have been measured at $T_{amb} = 25\text{ }^\circ\text{C}$, unless otherwise specified.

Analog voltage dimming

The analog dimming characteristic graph is shown in **Figure 5**. To achieve a linear change in LED current versus control voltage, the recommended range of voltage at En/PWM pin 3 is from 0.8 V to 2.5 V

$R_{sense} = 333\text{ m}\Omega$, $L = 100\text{ }\mu\text{H}$

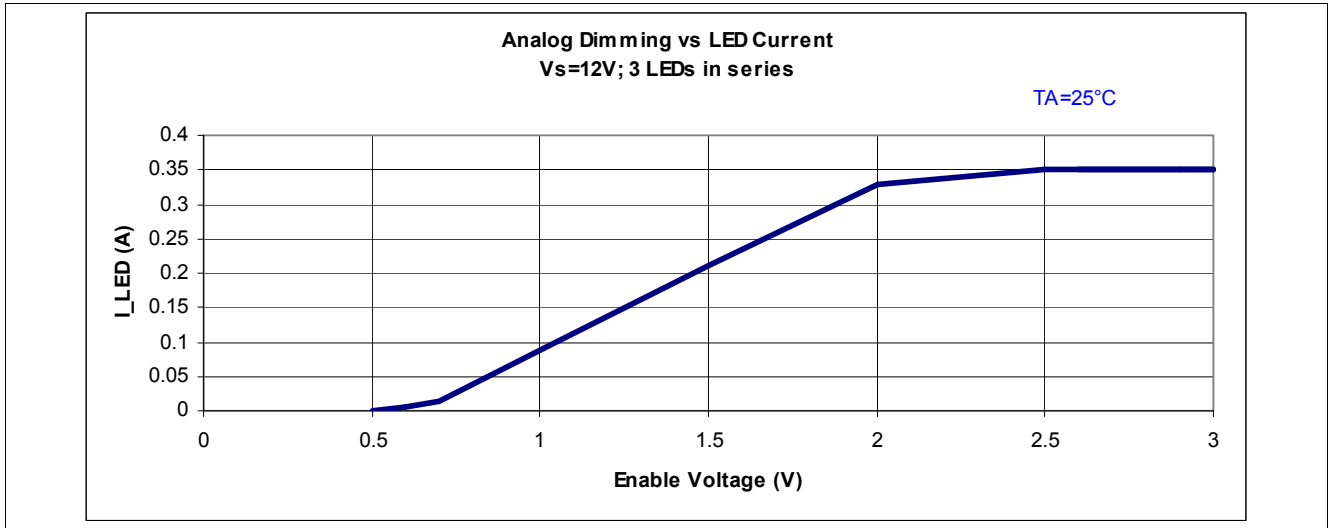

Figure 5 ILD4035; Analog Voltage Dimming

Table 7 Percentage of Max. LED Current vs. DC Voltage at Pin 3

V_{en} / PWM	Percentage of max. LED current %	V_{en} / PWM	Percentage of max. LED current %
< 0.3	0	1.9	75
0.8	10	2.2	90
1.0	25	> 2.5	100
1.4	50		

Analog voltage dimming characteristics with different Rsense resistors

The maximum LED current is set by R_{sense} . The three different graphs show the behaviour of the analog dimming. Maximum LED current will be achieved at approx. 2.3 Volts in every case.

L = 100 μ H

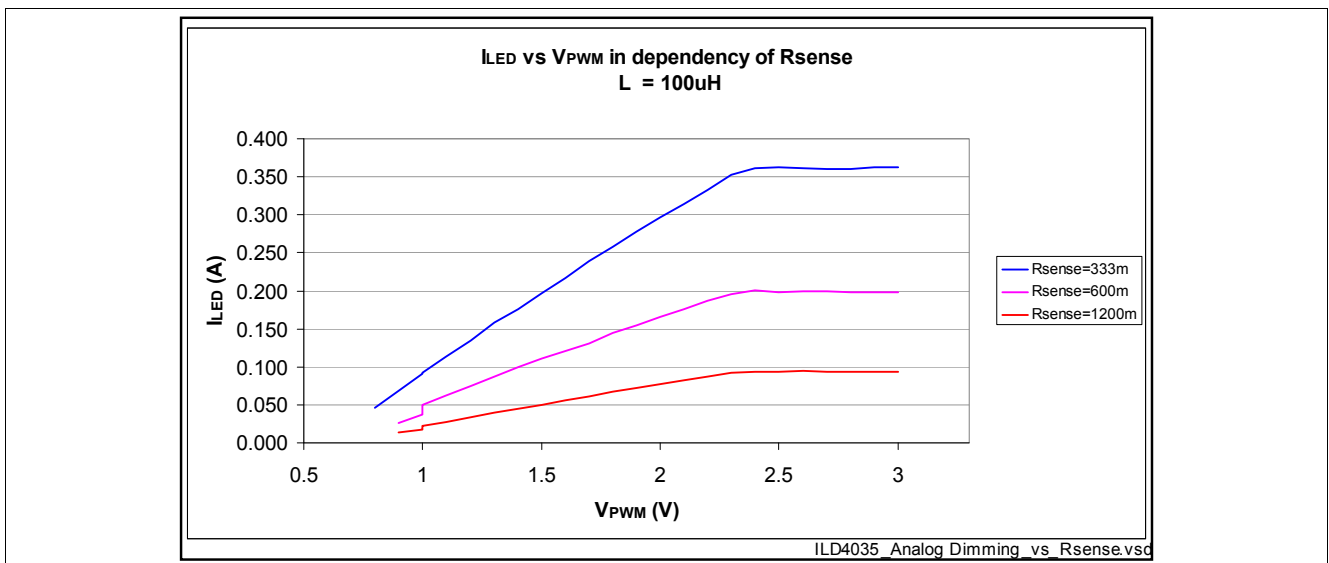

Figure 6 ILD4035; Analog Voltage Dimming with Different Rsense

PWM Dimming

The EM/PWM terminal on the PCB is an input for the pulse width modulated (PWM) signal to control the dimming of the LED string. The PWM signal's logic high level should be at least 2.6 V or higher. The period of this PWM signal should be higher than 200 μ s. For the default demo board circuit, a dimming frequency less than 300 Hz is recommended to maintain a maximum contrast ratio of at least 100:1. The maximum contrast ratio is shown on [Figure 7](#), and the minimum is based on the measured average LED current at 3dB below the linear reference. The maximum contrast ratio depends largely on the rise time of the inductor current, and hence is dependent on input voltage, inductor size, and LED string forward voltage.

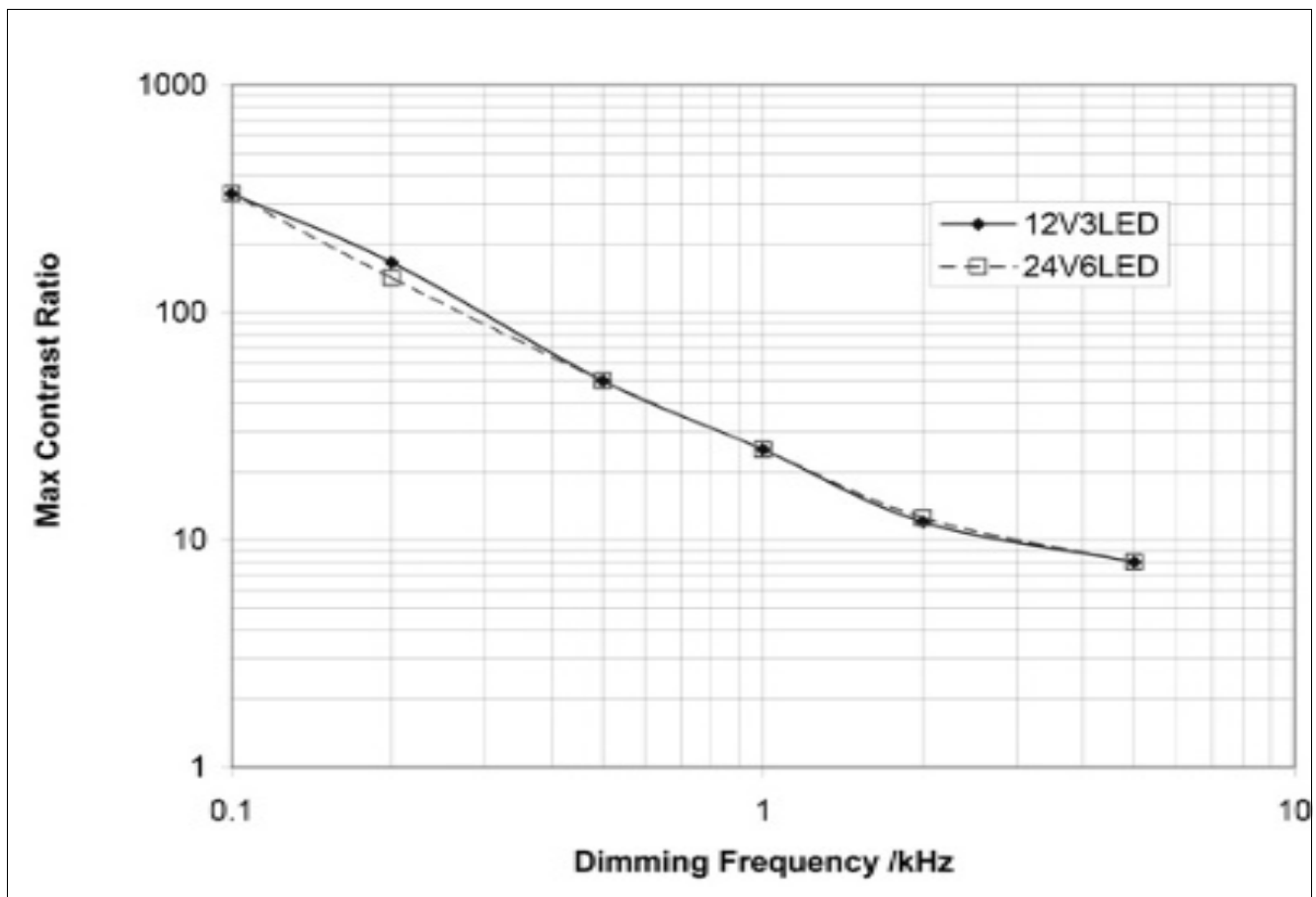

Figure 7 ILD4035; PWM Dimming

5.3 Temperature Characteristics of the ILD4035 Demo Board

The two charts below are related by the same supply voltage, V_s and number of LEDs.

For the same V_s and number of LEDs, the "solder point temperature at the ground pin" T_s and the "ambient temperature" T_A are measured at the same time.

Each curve on the charts defines two areas of operation.

The area below each curve defines normal operation.

The area above each curve defines the triggering of internal thermal shutdown.

When thermal shutdown is triggered, the LEDs start to flicker.

Conditions of Measurements

ILD4035 LED-Less board with

BAS3010A Schottky Diode,

Inductance=100uH (EPCOS 6x6mm)

R_{sense} =0.333 Ohm

Environment = Inside chamber with force convection air flow.

Thermal shutdown vs. solder temperature T_s

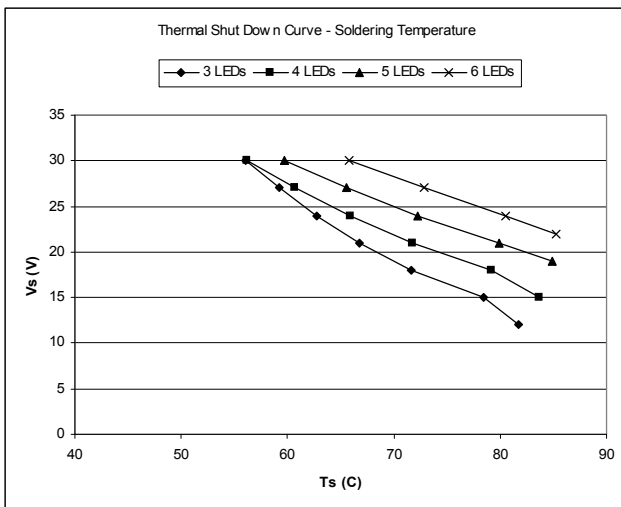

ILD4035_TSD_over_Ts.vsd

Thermal shutdown vs. ambient temperature T_A

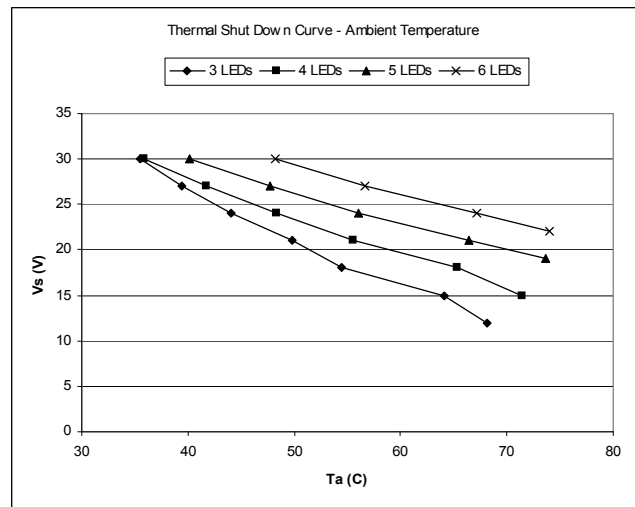

ILD4035_TSD_over_Ta.vsd

5.4 AC- Parameter

Typical operating conditions

All parameters have been measured at $T_{amb} = 25\text{ °C}$, unless otherwise specified.

ILD4035 IC has been measured in test bench with undefined high thermal resistance

This is valid for all diagramed AC- Parameters.

$R_{\text{sense}} = 303 \text{ m}\Omega$, $L = 100 \text{ }\mu\text{H}$
 $V_s = 24 \text{ V}$, 6 LED with typ. $V_F = 3 \text{ V}$

I_{LED} vs. V_{Supply} and number of LEDs

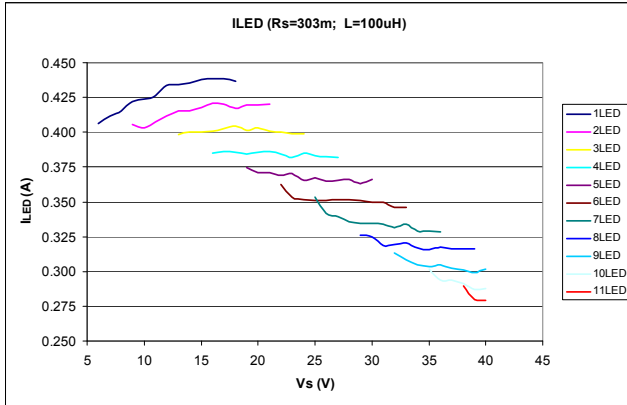

ILD4035_ILED_303m_100u.vsd

F_{Switch} vs. V_{Supply} and number of LEDs

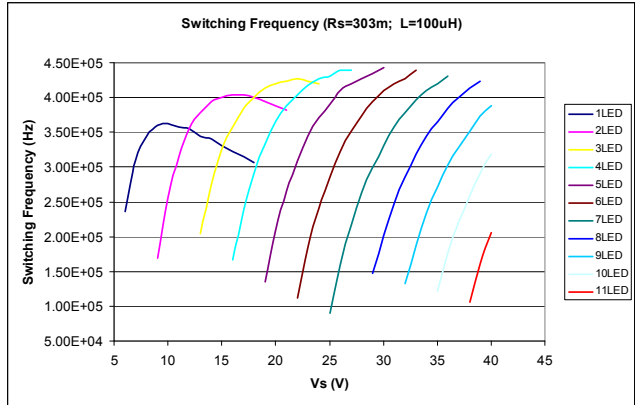

ILD4035_Switching_Frequency_303m_100u.vsd

Efficiency vs. V_{Supply} and number of LEDs

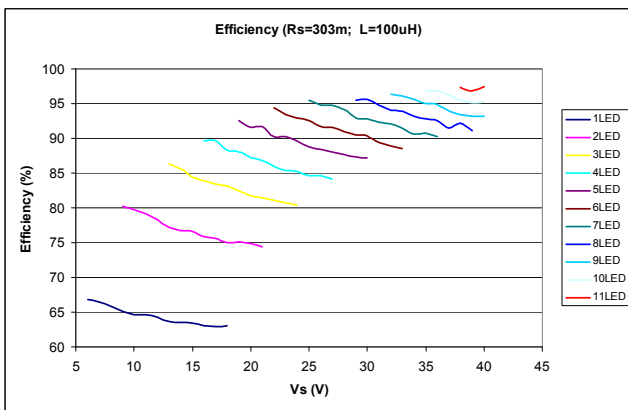

ILD4035_Efficiency_303m_100u.vsd

Duty Cycle vs. V_{Supply} and number of LEDs

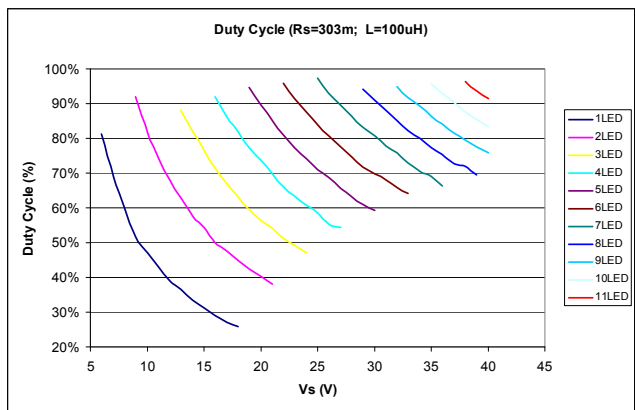

ILD4035_Duty_Cycle_303m_100u.vsd

$R_{\text{sense}} = 303 \text{ m}\Omega$, $L = 68 \text{ }\mu\text{H}$

$V_s = 24 \text{ V}$, 6 LED with typ. $V_F = 3 \text{ V}$

I_{LED} vs. V_{Supply} and number of LEDs

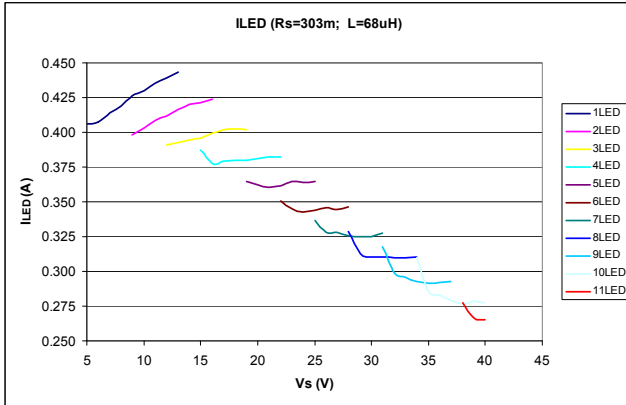

ILD4035_I_LED_303m_68u.vsd

F_{Switch} vs. V_{Supply} and number of LEDs

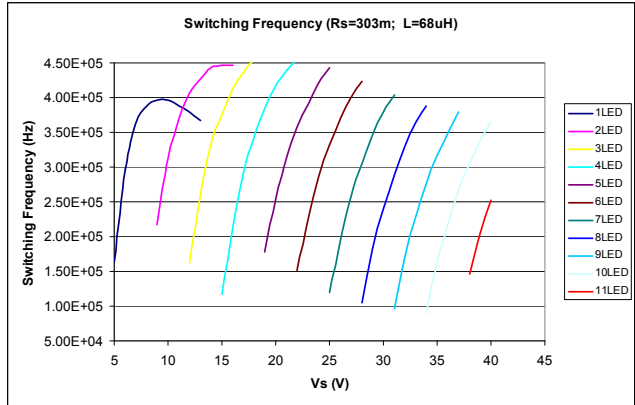

ILD4035_Switching_Frequency_303m_68u.vsd

Efficiency vs. V_{Supply} and number of LEDs

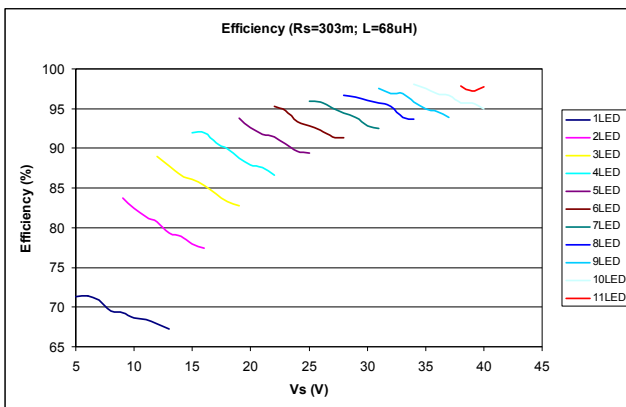

ILD4035_Efficiency_303m_68u.vsd

Duty Cycle vs. V_{Supply} and number of LEDs

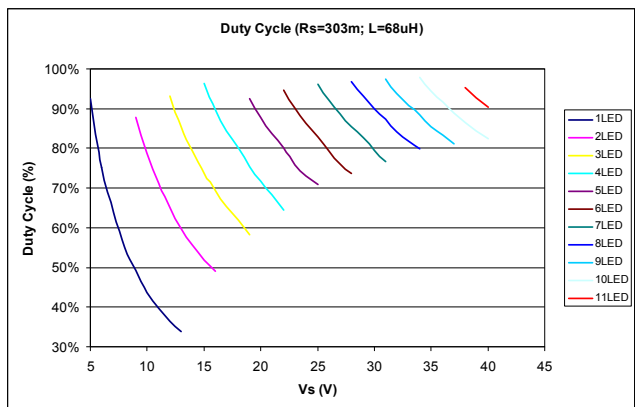

ILD4035_Duty_Cycle_303m_68u.vsd

$R_{sense} = 303 \text{ m}\Omega$, $L = 220 \text{ }\mu\text{H}$
 $V_s = 24 \text{ V}$, 6 LED with typ. $V_F = 3 \text{ V}$

I_{LED} vs. V_{Supply} and number of LEDs

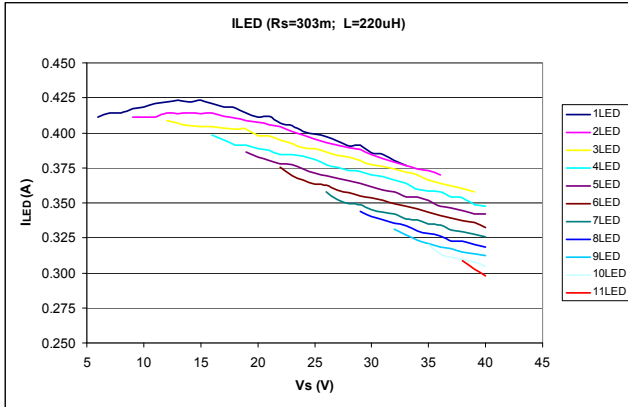

ILD4035_I_LED_303m_220u.vsd

F_{Switch} vs. V_{Supply} and number of LEDs

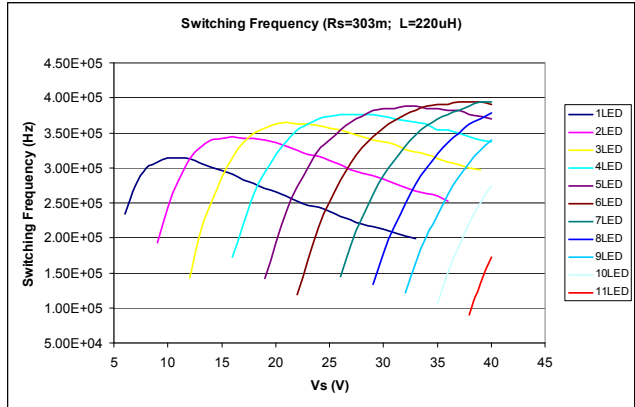

ILD4035_Switching_Frequency_303m_220u.vsd

Efficiency vs. V_{Supply} and number of LEDs

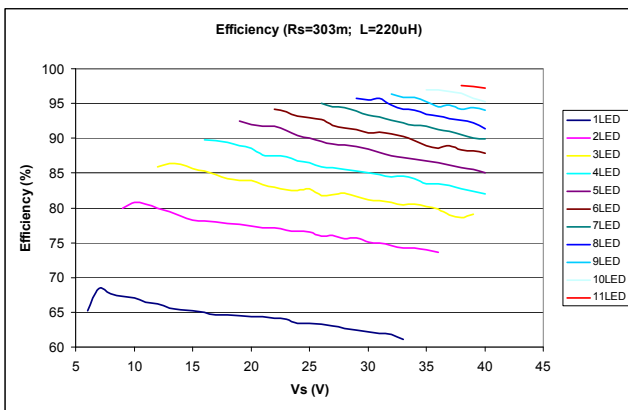

ILD4035_Efficiency_303m_220u.vsd

Duty Cycle vs. V_{Supply} and number of LEDs

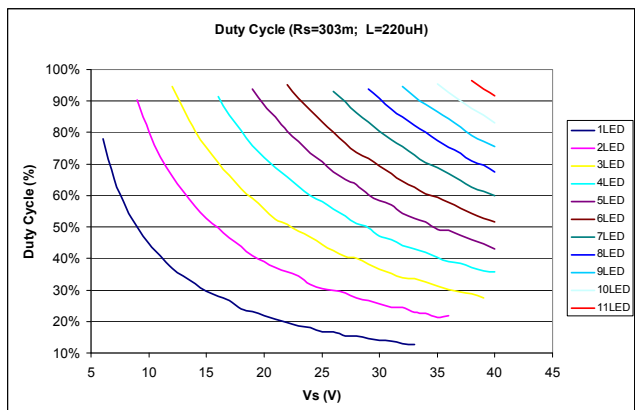

ILD4035_Duty_Cycle_303m_220u.vsd

$R_{\text{sense}} = 303 \text{ m}\Omega$, $L = 47 \text{ }\mu\text{H}$
 $V_s = 24 \text{ V}$, 6 LED with typ. $V_F = 3 \text{ V}$

I_{LED} vs. V_{Supply} and number of LEDs

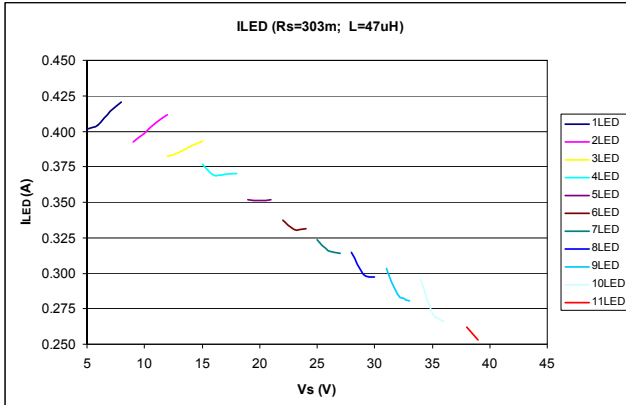

ILD4035_ILED_303m_47u.vsd

F_{Switch} vs. V_{Supply} and number of LEDs

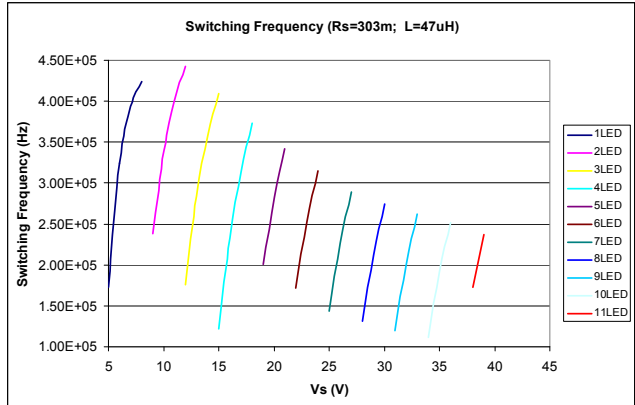

ILD4035_Switching_Frequency_303m_47u.vsd

Efficiency vs. V_{Supply} and number of LEDs

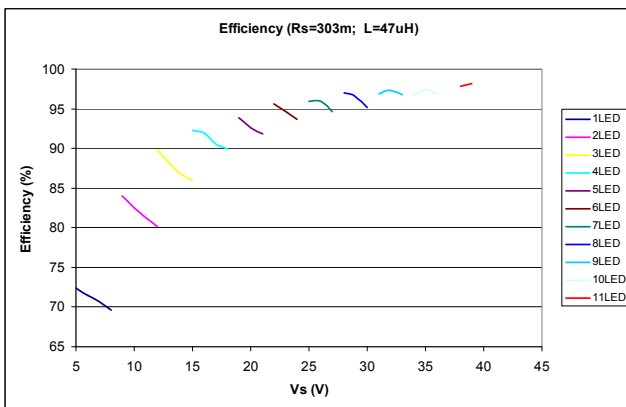

ILD4035_Efficiency_303m_47u.vsd

Duty Cycle vs. V_{Supply} and number of LEDs

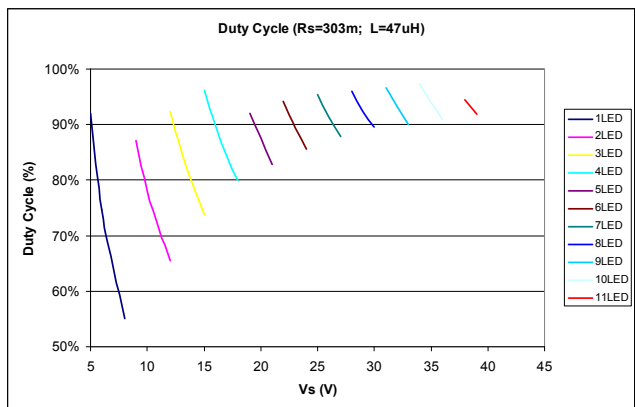

ILD4035_Duty_Cycle_303m_47u.vsd

$R_{sense} = 367 \text{ m}\Omega$, $L = 100 \text{ }\mu\text{H}$
 $V_s = 24 \text{ V}$, 6 LED with typ. $V_F = 3 \text{ V}$

I_{LED} vs. V_{Supply} and number of LEDs

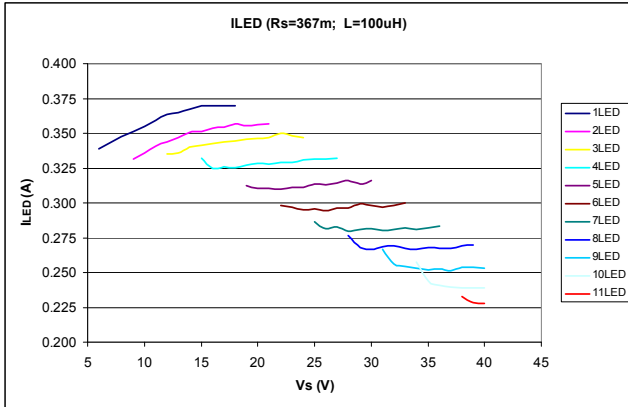

ILD4035_I_LED_367m_100u.vsd

F_{Switch} vs. V_{Supply} and number of LEDs

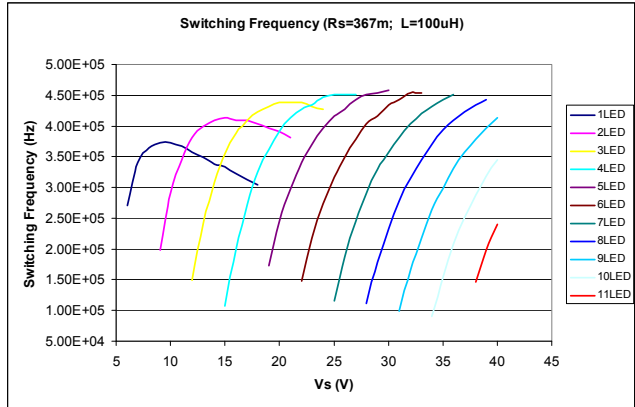

ILD4035_Switching_Frequency_367m_100u.vsd

Efficiency vs. V_{Supply} and number of LEDs

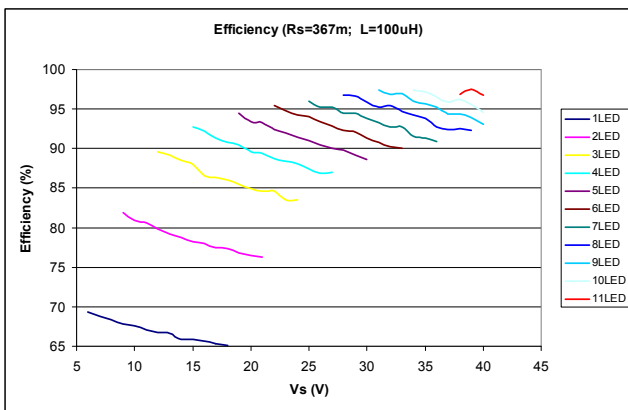

ILD4035_Efficiency_367m_100u.vsd

Duty Cycle vs. V_{Supply} and number of LEDs

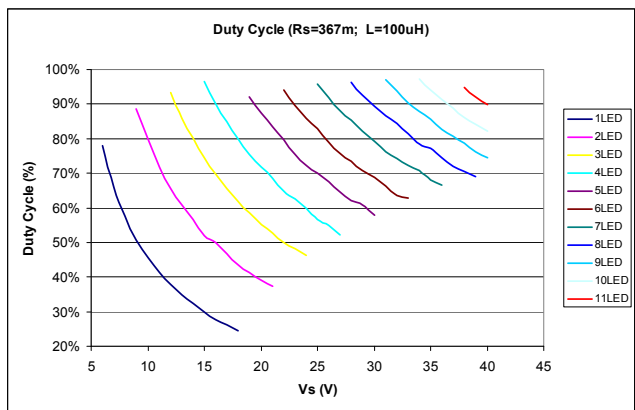

ILD4035_Duty_Cycle_367m_100u.vsd

$R_{sense} = 367 \text{ m}\Omega$, $L = 68 \text{ }\mu\text{H}$

$V_s = 12 \text{ V}$, 3 LED with typ. $V_F = 3 \text{ V}$

I_{LED} vs. V_{Supply} and number of LEDs

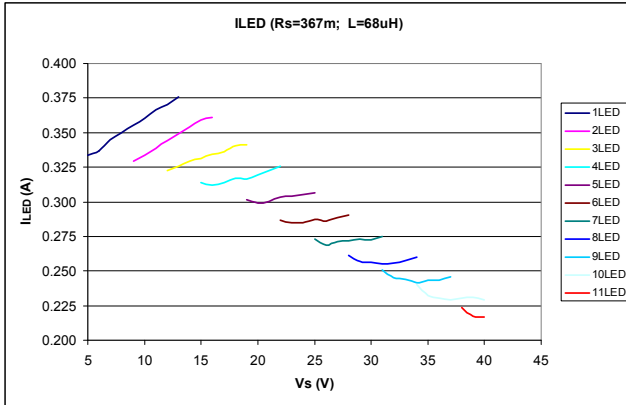

ILD4035_ILED_367m_68u.vsd

F_{Switch} vs. V_{Supply} and number of LEDs

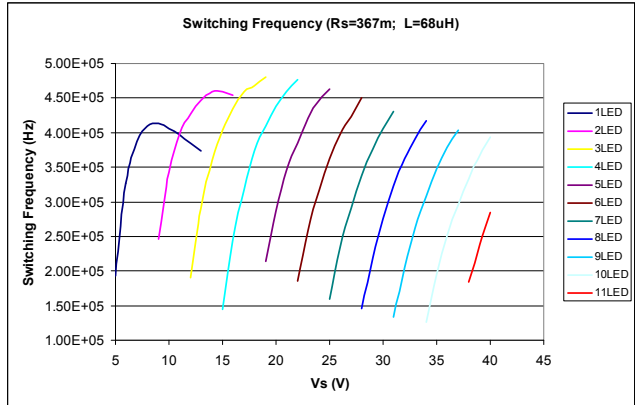

ILD4035_Switching_Frequency_367m_68u.vsd

Efficiency vs. V_{Supply} and number of LEDs

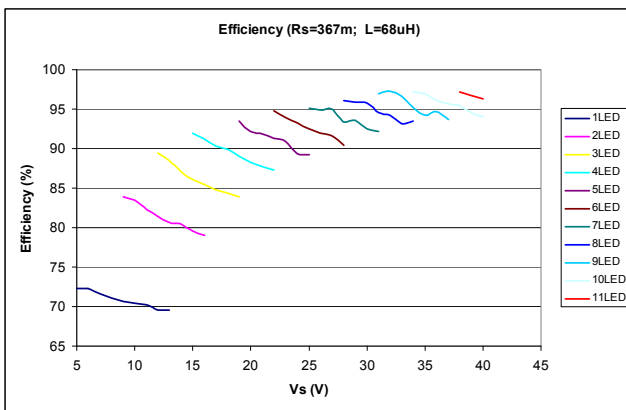

ILD4035_Efficiency_367m_68u.vsd

Duty Cycle vs. V_{Supply} and number of LEDs

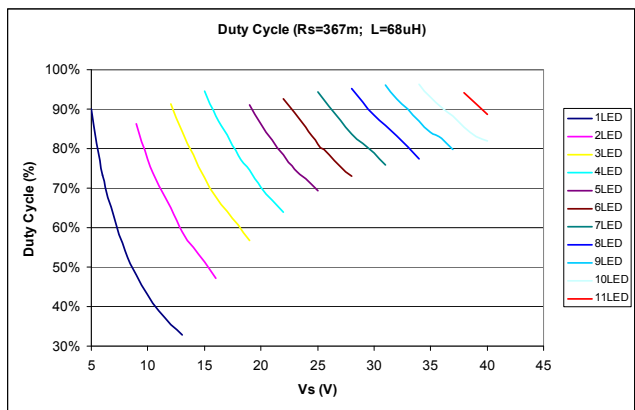

ILD4035_Duty_Cycle_367m_68u.vsd

$R_{\text{sense}} = 367 \text{ m}\Omega$, $L = 220 \text{ }\mu\text{H}$
 $V_s = 12 \text{ V}$, 3 LED with typ. $V_F = 3 \text{ V}$

I_{LED} vs. V_{Supply} and number of LEDs

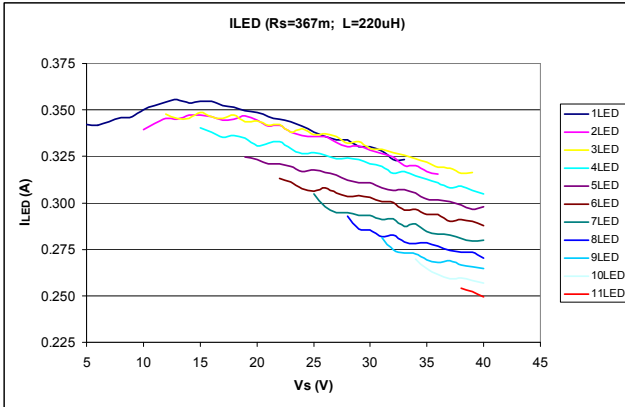

ILD4035_I_LED_367m_220u.vsd

F_{Switch} vs. V_{Supply} and number of LEDs

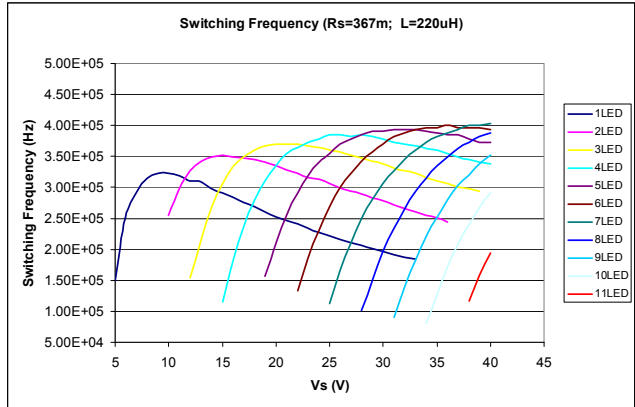

ILD4035_Switching_Frequency_367m_220u.vsd

Efficiency vs. V_{Supply} and number of LEDs

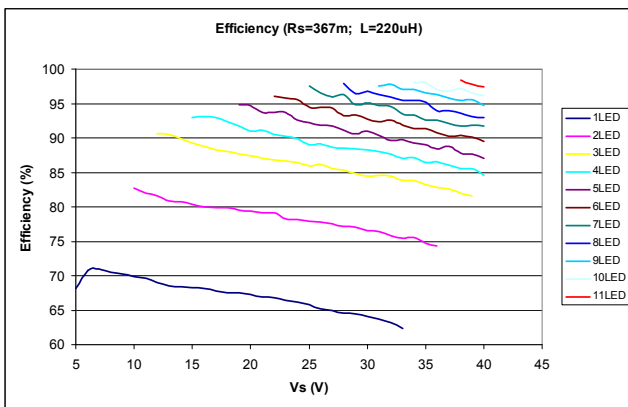

ILD4035_Efficiency_367m_220u.vsd

Duty Cycle vs. V_{Supply} and number of LEDs

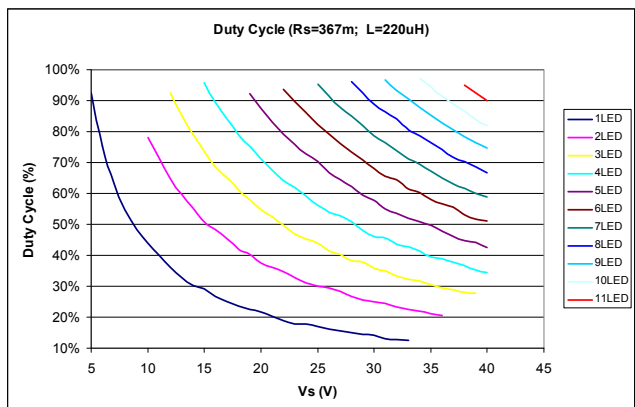

ILD4035_Duty_Cycle_367m_220u.vsd

$R_{sense} = 367 \text{ m}\Omega$, $L = 47 \text{ }\mu\text{H}$

$V_s = 12 \text{ V}$, 3 LED with typ. $V_F = 3 \text{ V}$

I_{LED} vs. V_{Supply} and number of LEDs

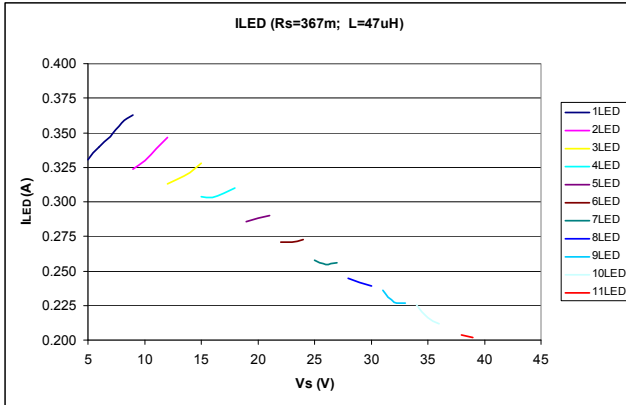

ILD4035_ILED_367m_47u.vsd

F_{Switch} vs. V_{Supply} and number of LEDs

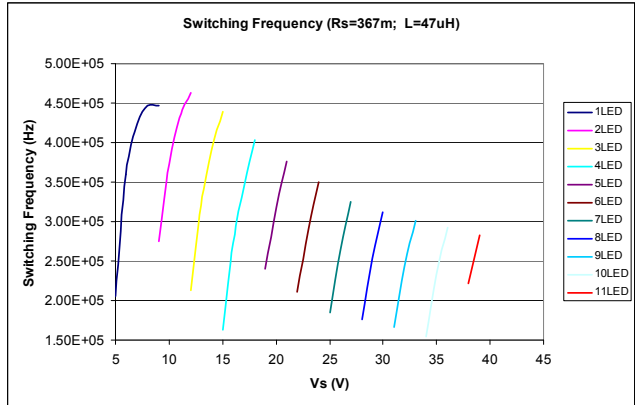

ILD4035_Switching_Frequency_367m_47u.vsd

Efficiency vs. V_{Supply} and number of LEDs

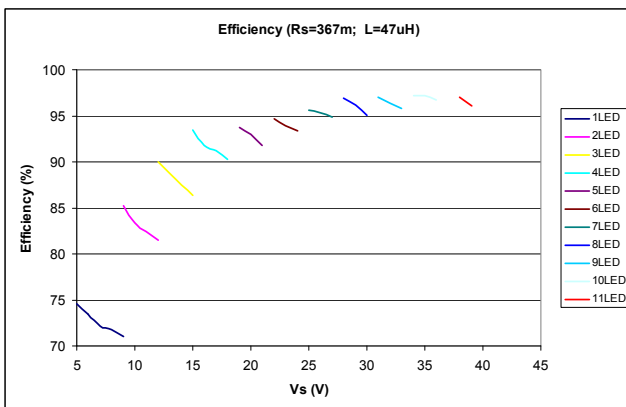

ILD4035_Efficiency_367m_47u.vsd

Duty Cycle vs. V_{Supply} and number of LEDs

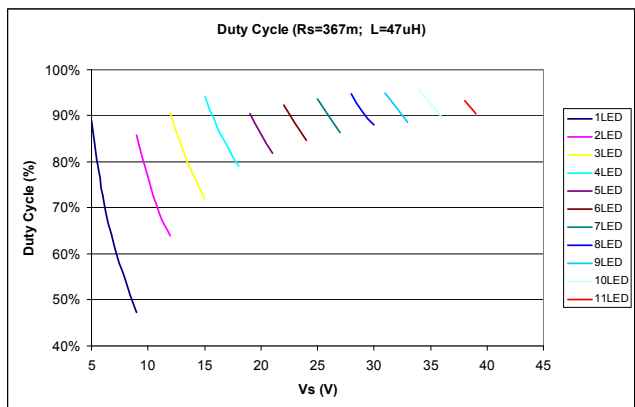

ILD4035_Duty_Cycle_367m_47u.vsd

6 Application Circuit

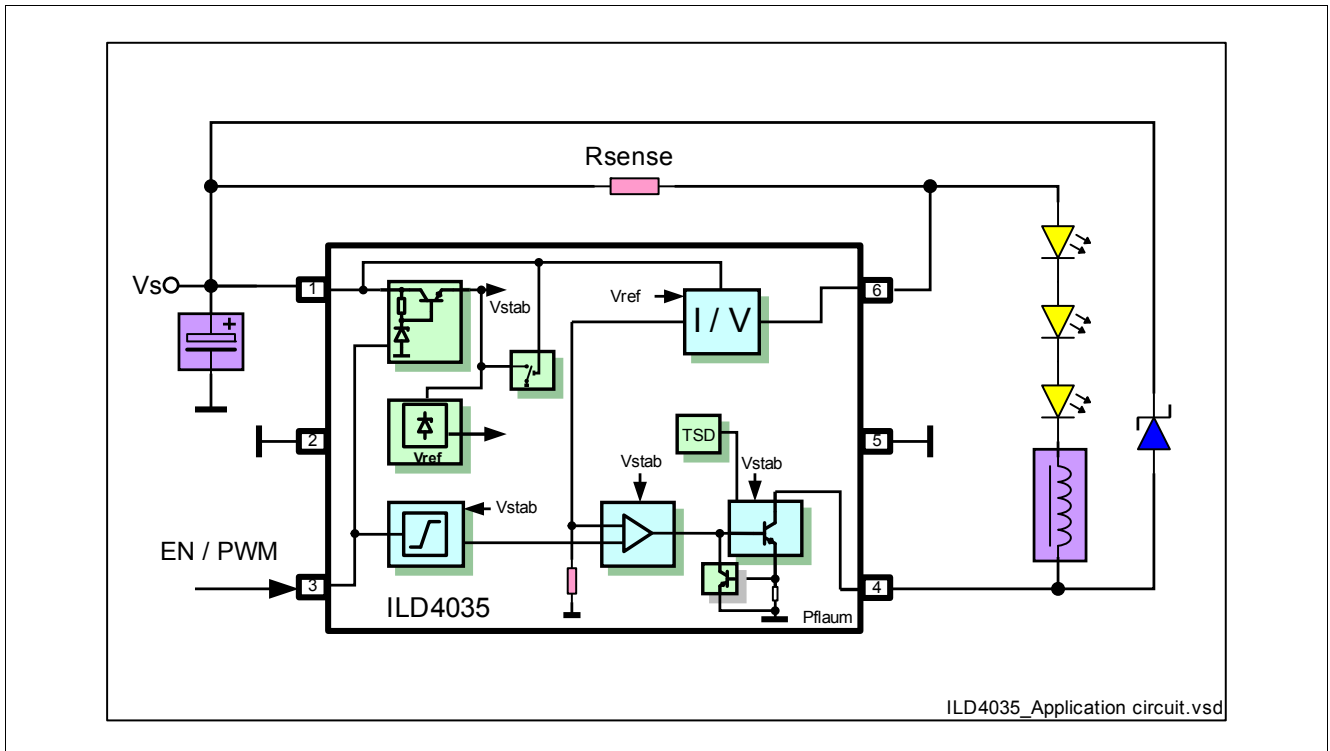

Figure 8 ILD4035; Application Circuit

7 Evaluation Board

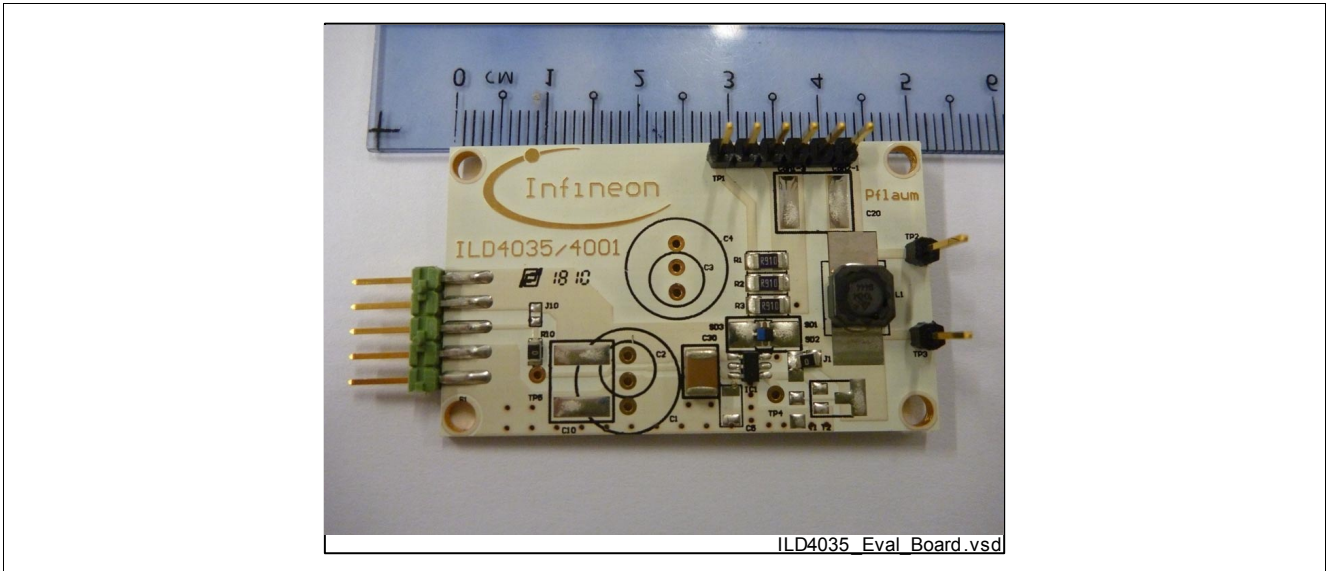

Figure 9 ILD4035; Evaluation- Board

8 Package Information SC74-6-4

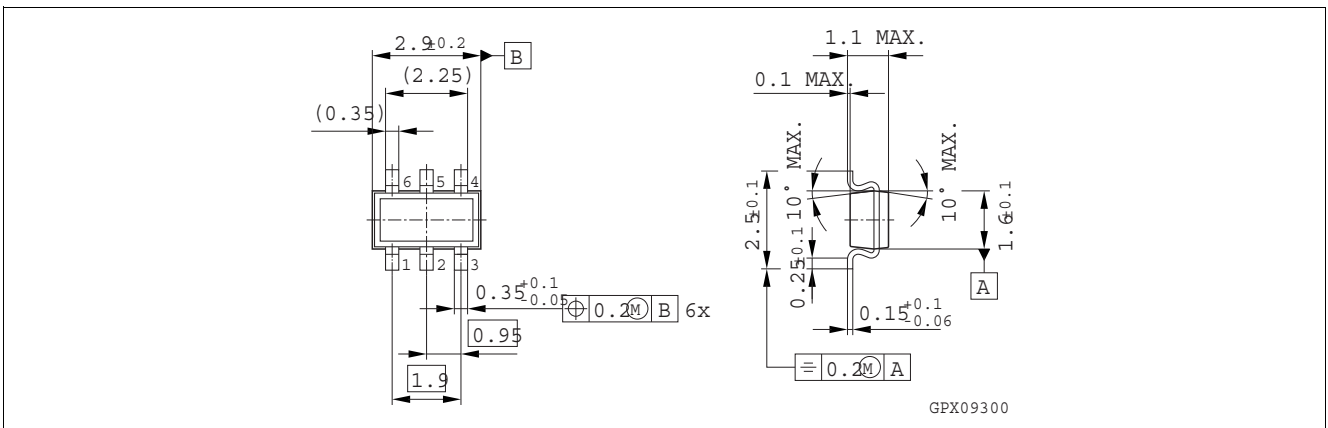

Figure 10 Package Outline

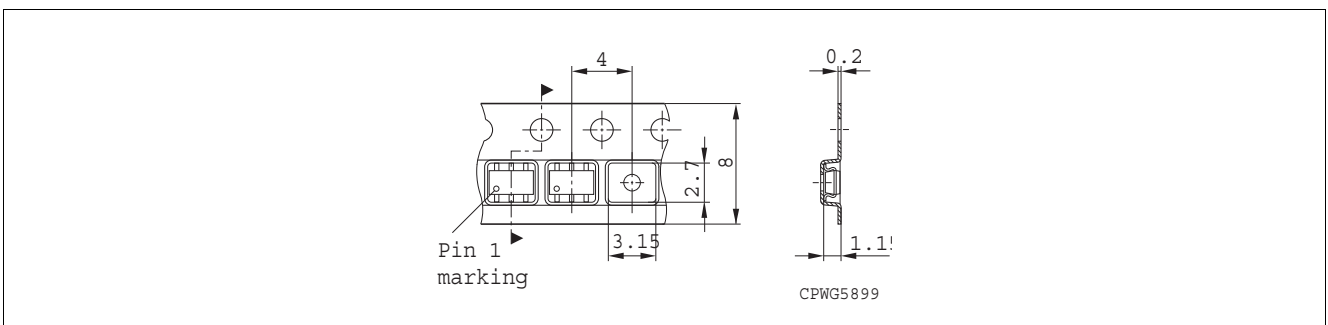

Figure 11 Tape Dimensions

www.infineon.com

Published by Infineon Technologies AG