

PLEASE CHECK WWW.MOLEX.COM FOR LATEST PART INFORMATION

Part Number: [0674910025](#)
Status: **Active**
Overview: Serial ATA Products
Description: 1.27mm (.050") Pitch Serial ATA High Speed Header, Through Hole, Vertical, 7 Circuits, Gold (Au) Flash, with 2.35mm (.093") PC Tail Length, Lead-free

Documents:

[3D Model](#) [Product Specification PS-67491-001 \(PDF\)](#)
[Drawing \(PDF\)](#) [RoHS Certificate of Compliance \(PDF\)](#)

General

Product Family	PCB Headers
Series	67491
Application	Board-to-Board, Wire-to-Board
Overview	Serial ATA Products
Product Name	Serial ATA

Physical

Breakaway	No
Circuits (Loaded)	7
Color - Resin	Black
Durability (mating cycles max)	50
First Mate / Last Break	Yes
Glow-Wire Compliant	No
Guide to Mating Part	No
Keying to Mating Part	Yes
Lock to Mating Part	Yes
Material - Plating Mating	Gold
Material - Plating Termination	Tin
Number of Rows	1
Orientation	Vertical
PC Tail Length (in)	0.093 In
PC Tail Length (mm)	2.35 mm
PCB Locator	Yes
PCB Retention	Yes
PCB Thickness Recommended (in)	0.062 In
PCB Thickness Recommended (mm)	1.60 mm
Packaging Type	Tray
Pitch - Mating Interface (in)	0.050 In
Pitch - Mating Interface (mm)	1.27 mm
Pitch - Term. Interface (in)	0.050 In
Pitch - Term. Interface (mm)	1.27 mm
Plating min: Mating (µin)	2
Plating min: Mating (µm)	0.05
Plating min: Termination (µin)	50.8
Plating min: Termination (µm)	1.27
Polarized to Mating Part	Yes
Polarized to PCB	Yes
Shrouded	No
Stackable	No
Surface Mount Compatible (SMC)	No
Temperature Range - Operating	-35°C to +85°C
Termination Interface: Style	Through Hole

Electrical

Current - Maximum per Contact	1.5A
-------------------------------	------

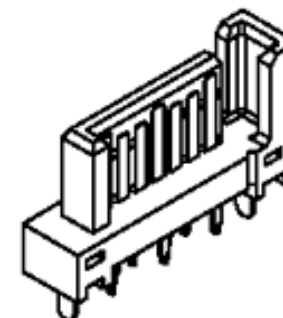

Series

image - Reference only

EU RoHS

ELV and RoHS Compliant

REACH SVHC

Not Reviewed

Halogen-Free

Status

Not Halogen-Free

China RoHS



Need more information on product environmental compliance?

Email productcompliance@molex.com
 For a multiple part number RoHS Certificate of Compliance, [click here](#)

Please visit the [Contact Us](#) section for any non-product compliance questions.

Search Parts in this Series

[67491Series](#)

Mates With

Serial ATA Signal Connector [67489](#) , [88755](#)

Voltage - Maximum 15V DC

Solder Process Data

Lead-free Process Capability Wave Capable (TH only)

Material Info

Reference - Drawing Numbers

Product Specification PS-67491-001
Sales Drawing SD-67491-001

This document was generated on 04/07/2010

PLEASE CHECK WWW.MOLEX.COM FOR LATEST PART INFORMATION

10 9 8 7 6 5 4 3 2 1

F
E
D
C
B
A

F
E
D
C
B
A

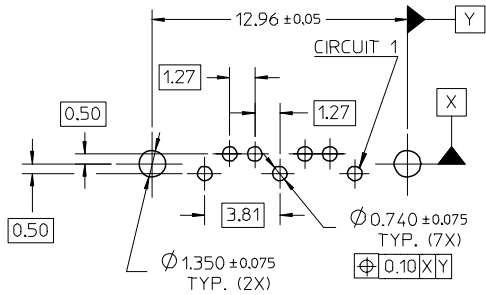
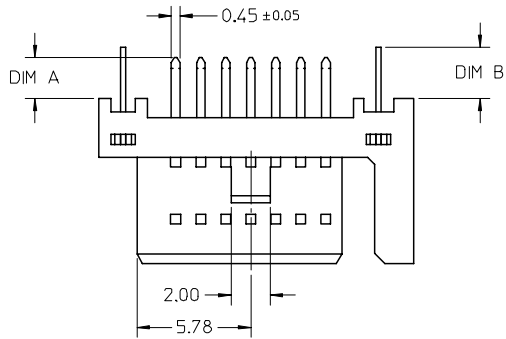

RECOMMENDED P.C.B. LAYOUT (T=1.6mm/2.0mm/2.4mm)

- NOTES:
- MATERIAL:
HOUSING: THERMAL PLASTIC, UL94V-0, COLOR: SEE SHEET2
TERMINAL/PEG: COPPER ALLOY, THICKNESS=0.25MM
 - TERMINAL PLATING:
CONTACT AREA: (a) GOLD FLASH
(b) 0.76 MICRON GOLD PLATED
(c) 0.38 MICRON GOLD PLATED
 - SOLDER TAIL:
1.27 MICRON MIN. MATTE TIN PLATED
UNDER PLATE:
1.27 MICRON MIN. NICKEL PLATED
 - PEG PLATING:
1.27 MICRON MIN. MATTE TIN PLATED OVERALL
1.27 MICRON MIN. NICKEL UNDER PLATED
 - PACKAGING SPECIFICATION REFER TO PK-67491-001
 - PRODUCT SPECIFICATION REFER TO PS-67491-001
 - MATING PART: 67489
 - RECOMMENDED PROCESS: WAVE SOLDERING

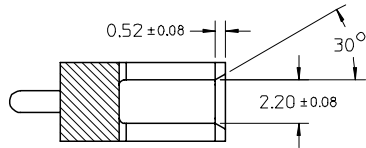
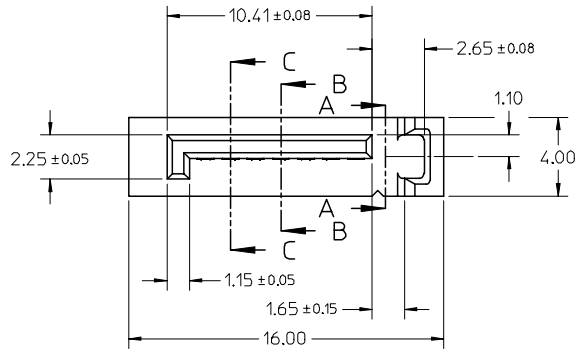

SECTION A-A

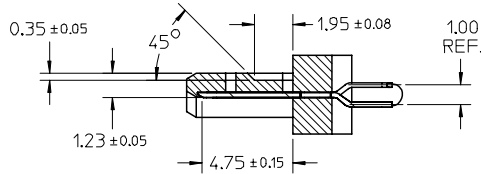

SECTION B-B

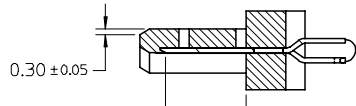

SECTION C-C

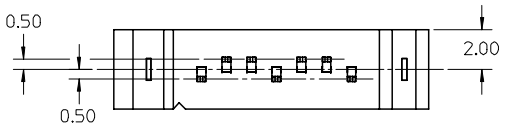
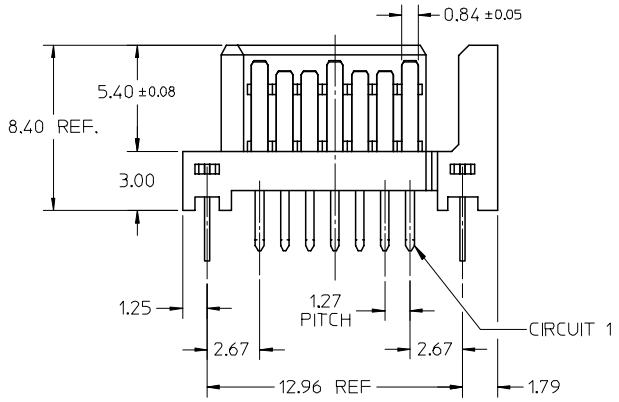
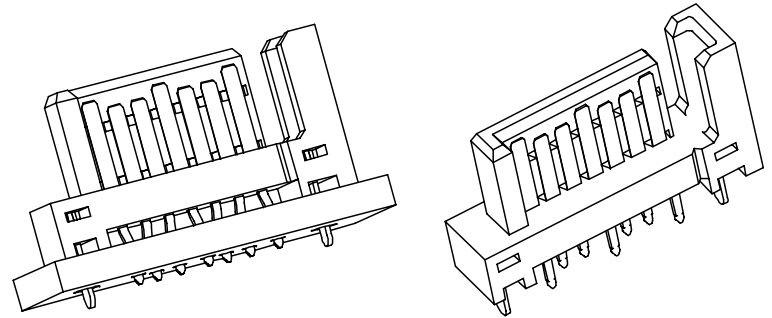

ADD PART NUMBER EC NO: SH2007-0895 DRWN: BCHENZ6 CHKD: JTIAN APPR: INCHEM 2007/06/15 2007/06/18 2007/06/22	QUALITY SYMBOLS ▽=0 ◁=0	GENERAL TOLERANCES (UNLESS SPECIFIED)		DIMENSION STYLE MM ONLY	SCALE 4:1	DESIGN UNITS METRIC	THIRD ANGLE PROJECTION				
		4 PLACES ± --- ± ---	3 PLACES ± --- ± ---	2 PLACES ± 0.15 ± ---	1 PLACE ± 0.25 ± ---	ANGLUAR ± 3 °	DRAWN BY GRATE MA	DATE 2004/02/02	TITLE 1.27MM HIGH SPEED PLUG VERTICAL TYPE		
		DRAFT WHERE APPLICABLE MUST REMAIN WITHIN DIMENSIONS		MATERIAL NO. SEE SHEET2	APPROVED BY SAM	DATE 2004/02/02	MOLEX INCORPORATED		DOCUMENT NO. SD-67491-001	SHEET NO. 1 OF 2	
		THIS DRAWING CONTAINS INFORMATION THAT IS PROPRIETARY TO MOLEX INCORPORATED AND SHOULD NOT BE USED WITHOUT WRITTEN PERMISSION									

9 8 7 6 5 4 3 2 1

	10	9	8	7	6	5	4	3	2	1		
	P/N	PLATING TYPE	DIM "A"	DIM "B"	COLOR	SOLDE AREA PLATING						
F	67491-0020	SEE NOTE 2(a)	2.05	2.57	BLACK	PURE TIN MATTE FINISH	▽ G					
	67491-0021	SEE NOTE 2(b)										
	67491-0022	SEE NOTE 2(c)										
	67491-0025	SEE NOTE 2(a)										
	67491-0026	SEE NOTE 2(b)	2.35									
67491-0027	SEE NOTE 2(c)											
E	67491-2020	SEE NOTE 2(a)	2.05	3.20	BLUE PANTONE NO. 293C ΔE<3							
	67491-2021	SEE NOTE 2(b)										
	67491-2022	SEE NOTE 2(c)										
	67491-2025	SEE NOTE 2(a)	2.35									
	67491-2026	SEE NOTE 2(b)										
67491-2027	SEE NOTE 2(c)											
D	67491-3010	SEE NOTE 2(a)	3.00	3.20	BLACK							
	67491-3011	SEE NOTE 2(b)										
	67491-3012	SEE NOTE 2(c)										
	67491-3110	SEE NOTE 2(a)	3.00									
	67491-3111	SEE NOTE 2(b)										
67491-3112	SEE NOTE 2(c)											

ADD PART NUMBER EC NO: SH2007-0895 DRWN: B. CHENZ6 CHKD: J. TIAN APPR: J. CHEN	2007/06/15 2007/06/18 2007/06/22	DESCRIPTION REV	QUALITY SYMBOLS ▽=0 ▽=0	GENERAL TOLERANCES (UNLESS SPECIFIED)		DIMENSION STYLE MM ONLY		SCALE 4:1	DESIGN UNITS METRIC	THIRD ANGLE PROJECTION			
				4 PLACES ± --- ± --- 3 PLACES ± --- ± --- 2 PLACES ± 0.15 ± --- 1 PLACE ± 0.25 ± --- ANGULAR ± 3 °	mm INCH	DRAWN BY GRATE MA	DATE 2004/02/02	TITLE 1.27MM HIGH SPEED PLUG VERTICAL TYPE					
						CHECKED BY YA JUN	DATE 2004/02/02	MOLEX INCORPORATED					
						APPROVED BY SAM	DATE 2004/02/02	MATERIAL NO. SEE TABLE		DOCUMENT NO. SD-67491-001	SHEET NO. 2 OF 2		
						DRAFT WHERE APPLICABLE MUST REMAIN WITHIN DIMENSIONS	SIZE A3	THIS DRAWING CONTAINS INFORMATION THAT IS PROPRIETARY TO MOLEX INCORPORATED AND SHOULD NOT BE USED WITHOUT WRITTEN PERMISSION					