

## ISOLATED DC/DC CONVERTERS

18 Vdc - 75 Vdc Input 12 Vdc /12 A Output, 1/4 Brick



Aug. 19, 2010

*Bel Power Inc., a subsidiary of Bel Fuse Inc.*

### 0RQB-C5U12x

### RoHS Compliant

### Rev.D

- Isolated
- Fixed Frequency (260 kHz)
- High Efficiency
- High Power Density
- Input Under-Voltage Lockout
- Input Over-Voltage Lockout
- Output Over-Voltage Shutdown
- Class 1, Category 2, Isolated DC/DC Converter (refer to IPC-9592)
- UL60950-1 Recognized (UL/cUL) (Pending)
- Over Temperature Protection
- SCP/OCP
- Low Cost
- Remote On/Off
- Basic Isolation
- Positive/Negative Remote Sense
- Output Voltage Trim

### Applications

- Networking
- Computers and peripherals
- Telecommunications

### Description

The 0RQB-C5U12x is isolated dc/dc converter that operates from a wide input range (18 Vdc - 75 Vdc) and can cover both 24 Vdc and 48 Vdc input range. This unit will provide up to 144 W of output power. This unit is designed to be highly efficient and low cost. Features include remote on/off, over current protection, over voltage shut down, over temperature protection and under voltage lockout. This converter is provided in an industry standard 1/4 brick package.

### Part Selection

Output Voltage	Input Voltage	Max. Output Current	Max. Output Power	Typical Efficiency	Model Number Active High	Model Number Active Low
12 Vdc	18 Vdc - 75Vdc	12 A	144 W	93%	0RQB-C5U120	0RQB-C5U12L

**Note:** Add "G" suffix at the end of the model number to indicate Tray Packaging.

### Part Number Explanation

0 R QB - C5 U 12 x  
1 2 3 4 5 6 7

- 1---Through hole
- 2---RoHS 6, change "R" to "7" means RoHS 5
- 3---Series name
- 4---Series code
- 5---Input range (18-75V)
- 6---Output voltage (12V)
- 7---Suffix

# ISOLATED DC/DC CONVERTERS

18 Vdc - 75 Vdc Input 12 Vdc /12 A Output, 1/4 Brick



Aug. 19, 2010

Bel Power Inc., a subsidiary of Bel Fuse Inc.

## Absolute Maximum Ratings

Parameter	Min	Typ	Max	Unit	Notes
Continuous Input Voltage	-0.3	-	80	V	
Input Transient Voltage	-	-	100	V	100mS maximum
Remote On/Off	-0.3	-	18	V	
I/O Isolation Voltage	-	-	1500	V	
Ambient Temperature	-40	-	85	°C	
Storage Temperature	-55	-	125	°C	

**Note:** Ratings used beyond the maximum ratings may cause a reliability degradation of the converter or may permanently damage the device.

## Input Specifications

Parameter	Min	Typ	Max	Unit	Notes
Operating Input Voltage	18	24/48	75	V	
Input Current (full load)	-	9.2	-	A	Vin=18 V
	-	2.2	-	A	Vin=75 V
Input Current (no load)	-	100	130	mA	
Remote Off Input Current	-	30	45	mA	
Input Reflected Ripple Current (pk-pk)	-	40	60	mA	With simulated source impedance of 10 uH, 5 Hz to 20 MHz; Use a 1uF/100V ceramic capacitor and a 100uF/100V electrolytic capacitor with ESR=1 ohm max, at 200KHz@25°C.
Input Reflected Ripple Current (rms)	-	10	15	mA	
I <sup>2</sup> t Inrush Current Transient	-	-	0.5	A <sup>2</sup> s	
Turn-on Voltage Threshold	16.5	17.0	17.5	V	
Turn-off Voltage Threshold	15.5	16	16.5	V	
Input Over Voltage Lockout	76	78	80	V	

**CAUTION:** This converter is not internally fused. An input line fuse must be used in application.

Recommend a fast-acting fuse with maximum rating of 18A on system board. Refer to the fuse manufacture's datasheet for further information.

**Notes:** 1. This converter has internal C-L-C (0.47uF-0.47uH-8.8uF) filter.

2. All specifications are typical at 25 °C unless otherwise stated.

## Output Specifications

Parameter	Min	Typ	Max	Unit	Notes
Output Voltage Set Point	11.76	12.0	12.24	V	Vin=48V, Io=50% load
Load Regulation	-	±12	±24	mV	
Line Regulation	-	±12	±24	mV	
Regulation Over Temperature (-40deg.C-85deg.C)	-	±60	±100	mV	
Ripple and Noise (pk-pk)	-	100	160	mV	0 - 20 MHz BW, with 1 uF ceramic load capacitor and a 10 uF tantalum capacitor at output
Ripple and Noise (rms)	-	30	50	mV	

## ISOLATED DC/DC CONVERTERS

18 Vdc - 75 Vdc Input 12 Vdc /12 A Output, 1/4 Brick



Aug. 19, 2010

Bel Power Inc., a subsidiary of Bel Fuse Inc.

### Output Specifications (continued)

Parameter	Min	Typ	Max	Unit	Notes	
Output Ripple and Noise(pk-pk) under worst case	-	-	180	mV	over all operating input voltage, load and ambient temperature condition	
Output Current Range	0	-	12	A		
Output DC Current Limit	15	-	20	A		
Short Circuit Surge Transient	-	3	5	A <sup>2</sup> s		
Rise Time	5	-	10	mS		
Turn on Time	-	50	70	mS	Enable from Vin	
	-	50	70	mS	Enable from on/off	
Overshoot at Turn on	-	0	3	%		
Output Capacitance	0	-	680	uF		
<b>Transient Response</b>						
ΔV25%~50% of Max Load	Overshoot	-	400	600	mV	di/dt=0.1A/us, Vin=48 Vdc, with a 1 μF ceramic capacitor and a 10 uF Tantalum capacitor at output, Ta=25 °C.
	Settling Time	-	200	300	uS	
ΔV50%~25% of Max Load	Overshoot	-	400	600	mV	
	Settling Time	-	200	300	uS	

**Note:** All specifications are typical at nominal input, full load at 25°C unless otherwise stated.

### General Specifications

Parameter	Min	Typ	Max	Unit	Notes
Efficiency	91	93	-	%	Vin=24V, full load
	91	93	-	%	Vin=48V, full load
Switching Frequency	240	260	280	kHz	
Over Temperature Protection	-	125	-	°C	
Over Voltage Protection(Static)	-	14.5	-	V	This voltage is achieved by trimming up output slowly
Weight	-	48	-	g	
FIT	387			-	Calculated Per Bell Core SR-332 (Vin=48V, Vo=12V, Io=9.6A, Ta = 25 °C, FIT=10 <sup>9</sup> /MTBF)
Dimensions	Inches (L × W × H)	2.30 x 1.45 x 0.50		-	
	Millimeters (L × W × H)	58.42 x 36.83 x 12.69		-	
<b>Isolation characteristics</b>					
Input to Output	-	-	1500	V	
Input to Case	-	-	1500	V	
Output to Case	-	-	500	V	
Isolation Resistance	10M	-		ohm	
Isolation Capacitance	-	1500	-	pF	

**Note:** All specifications are typical at 25 °C unless otherwise stated.

# ISOLATED DC/DC CONVERTERS

18 Vdc - 75 Vdc Input 12 Vdc /12 A Output, 1/4 Brick



Aug. 19, 2010

*Bel Power Inc., a subsidiary of Bel Fuse Inc.*

## Efficiency Data

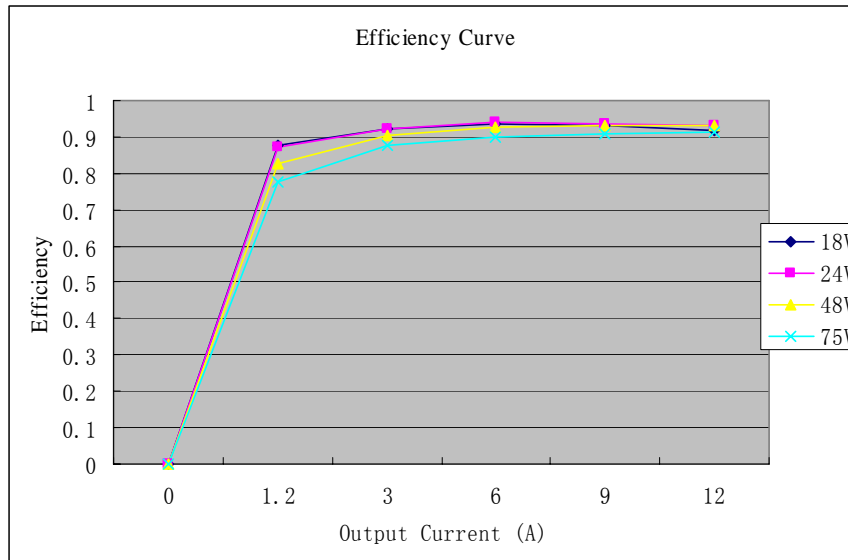

## Thermal Derating Curve

Maximum junction temperature of semiconductors derated to 120 degree C.

FORCED AIRFLOW

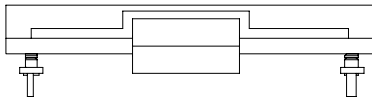
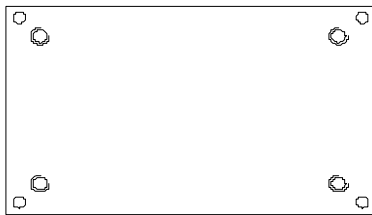
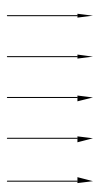

# ISOLATED DC/DC CONVERTERS

18 Vdc - 75 Vdc Input 12 Vdc /12 A Output, 1/4 Brick



Aug. 19, 2010

Bel Power Inc., a subsidiary of Bel Fuse Inc.

## Thermal Derating Curve (continued)

Derating curve under normal input

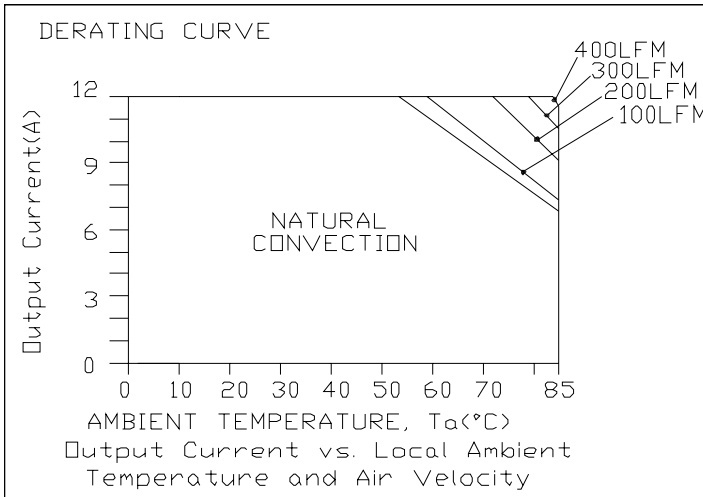

Vin=24V

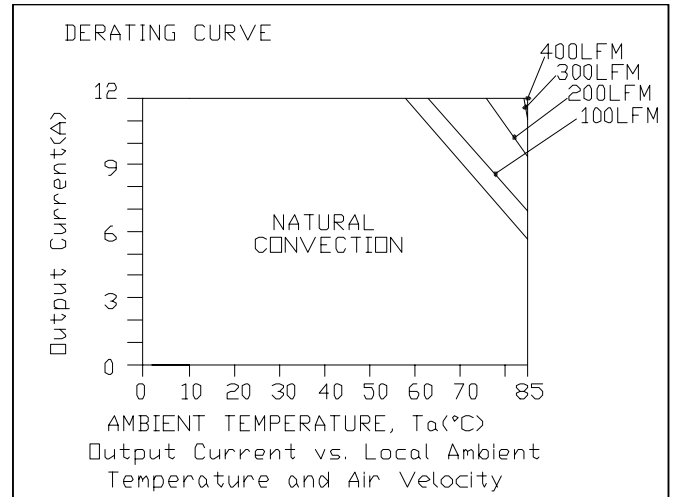

Vin=48V

Derating curve under worse case input

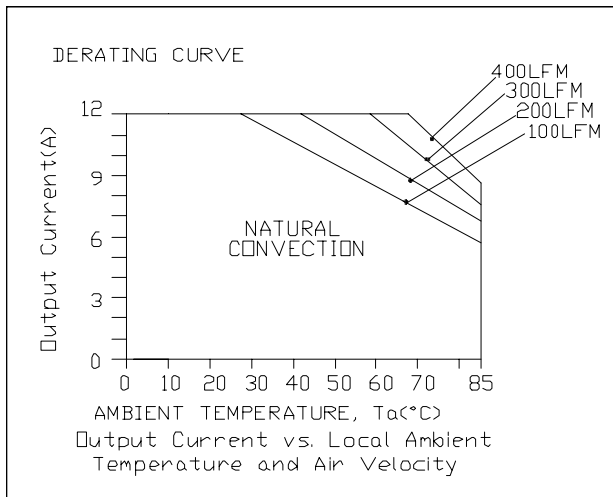

Vin=75V

# ISOLATED DC/DC CONVERTERS

18 Vdc - 75 Vdc Input 12 Vdc /12 A Output, 1/4 Brick



Aug. 19, 2010

Bel Power Inc., a subsidiary of Bel Fuse Inc.

## Thermal Derating Curve (continued)

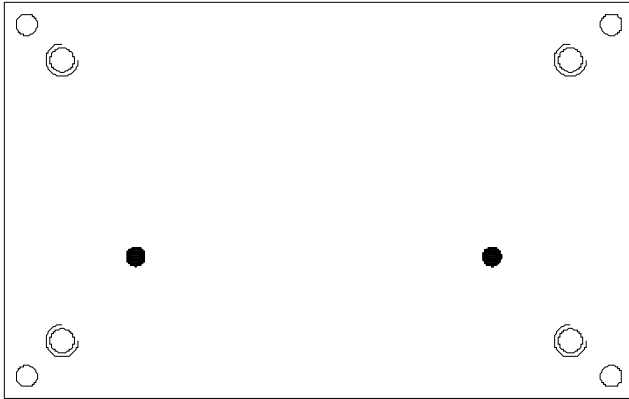

Temperature reference points on top side

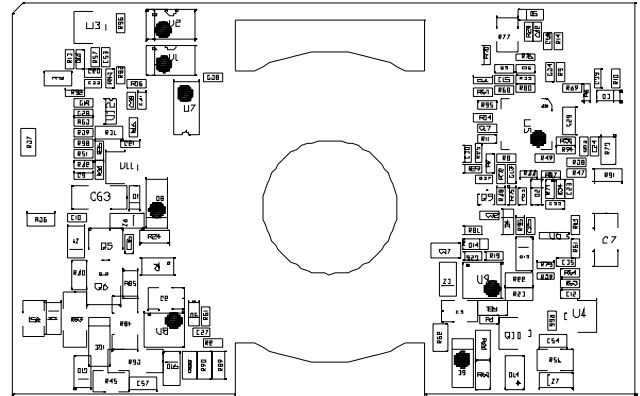

Temperature reference points on bottom side

## Ripple and Noise Waveform

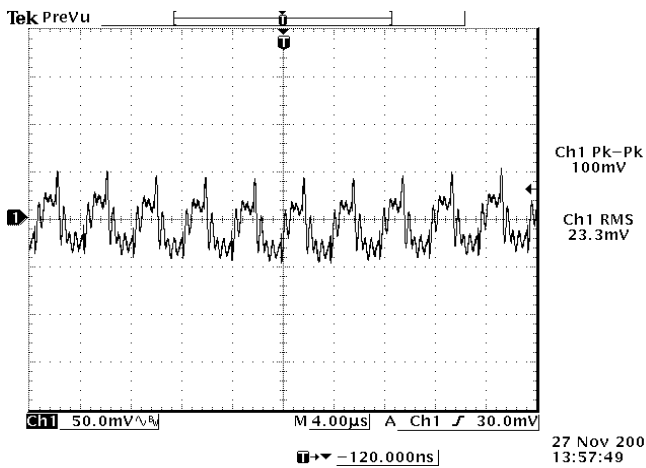

24 Vdc input, 12 Vdc/12 A output

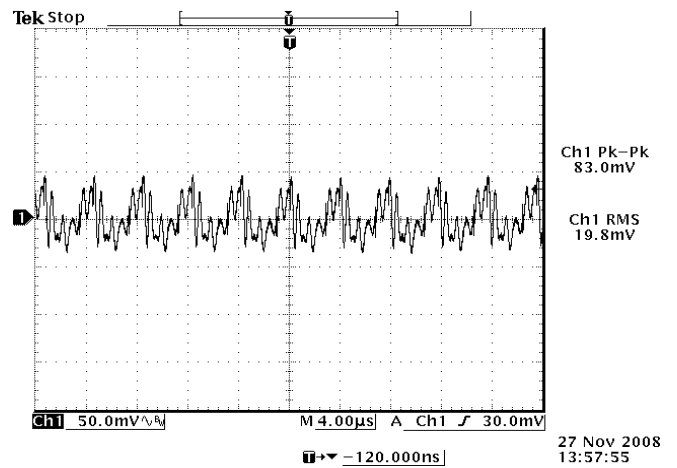

48 Vdc input, 12 Vdc/12 A output

**Note:** Ripple and noise at full load, 0-20MHz BW, with a 1µF ceramic capacitor and a 10 µF tantalum capacitor at the output, and Ta=25 deg C. .

Aug. 19, 2010

Bel Power Inc., a subsidiary of Bel Fuse Inc.

**Transients Responses Waveforms**

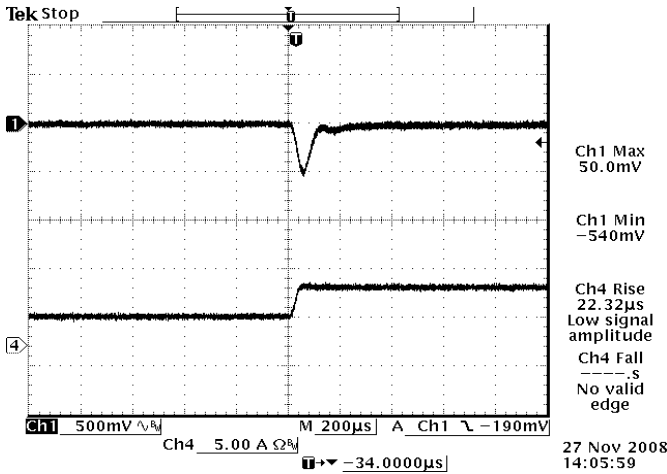

Vin=24V

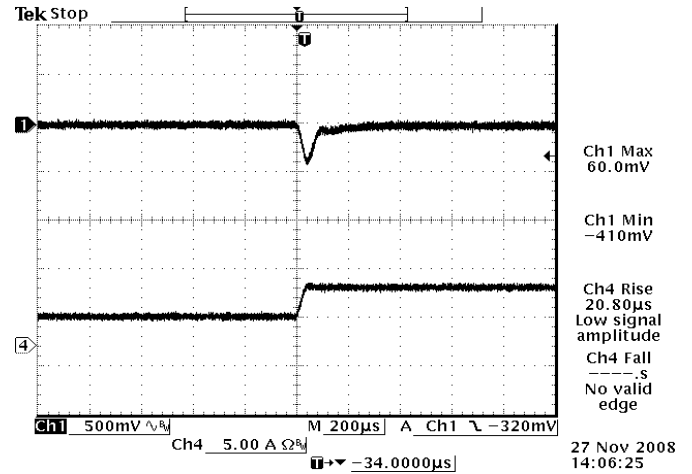

Vin=48V

Vout= 12V 25%-50% Load Transients at Ta=25°C

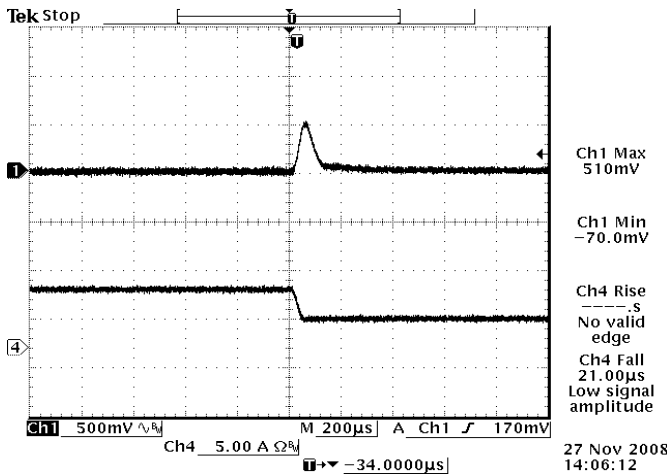

Vin=24V

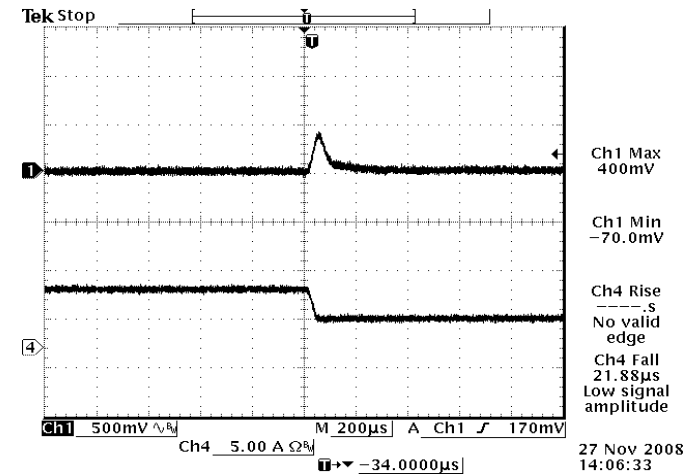

Vin=48V

Vout= 12V 50%-25% Load Transients at Ta=25°C

**Note:** Transients response at di/dt=0.1 A/us, with a 1 µF ceramic capacitor and a 10 uF tantalum capacitor at the output, Ta=25 deg C.

# ISOLATED DC/DC CONVERTERS

18 Vdc - 75 Vdc Input 12 Vdc /12 A Output, 1/4 Brick



Aug. 19, 2010

Bel Power Inc., a subsidiary of Bel Fuse Inc.

## Startup & Shutdown

### Rise time

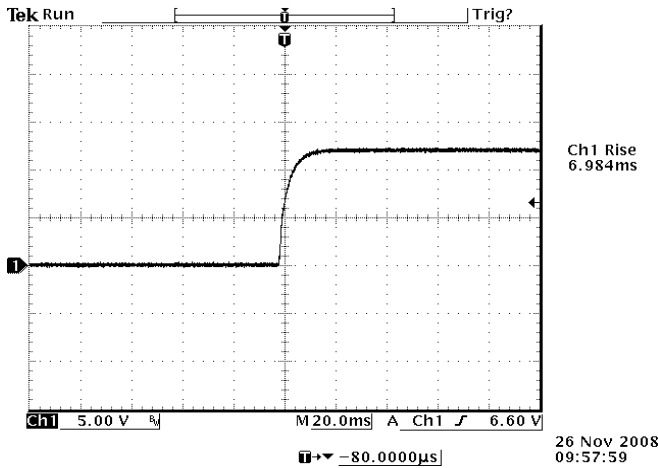

Vout= 12V/12A at Vin=48V@Ta=25°C

### Startup time

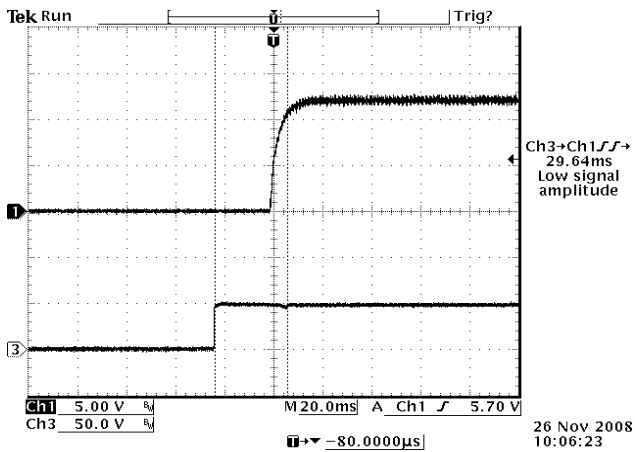

Startup from Vin  
Ch1: Vo  
Ch3: Vin  
Test Condition: 48Vin, 12A Load

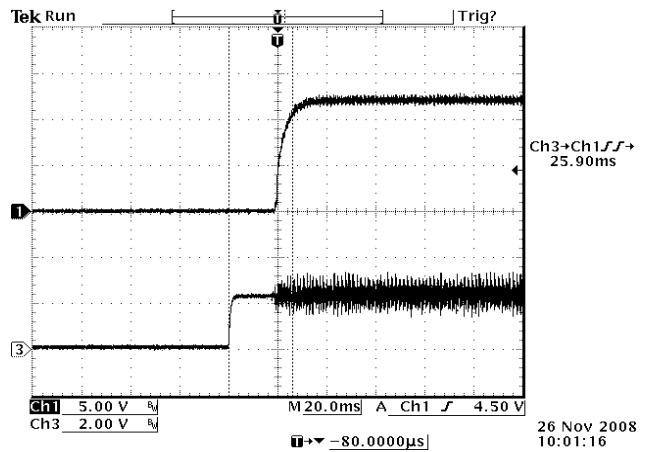

Startup from on/off  
Ch1: Vo  
Ch3: on/off  
Test Condition: 48Vin, 12A Load



# ISOLATED DC/DC CONVERTERS

18 Vdc - 75 Vdc Input 12 Vdc /12 A Output, 1/4 Brick



Aug. 19, 2010

Bel Power Inc., a subsidiary of Bel Fuse Inc.

## Startup & Shutdown (continued)

### Shutdown

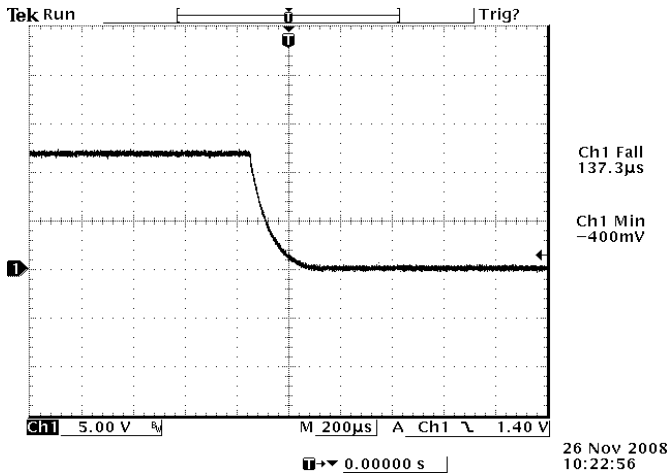

Test Condition: 48Vin, 12A Load

### Remote On/Off

Parameter		Min	Typ	Max	Unit	Notes
Signal Low (Unit On)	Active Low	-0.3	-	0.8	V	0RQB-C5U12L. The remote on/off pin open, Unit off.
Signal High (Unit Off)		2.4	-	18	V	
Signal Low (Unit Off)	Active High	-0.3	-	0.8	V	0RQB-C5U120. The remote on/off pin open, Unit on.
Signal High (Unit On)		2.4	-	18	V	
Current Sink		0	-	1	mA	

### Recommended remote on/off circuit for active low

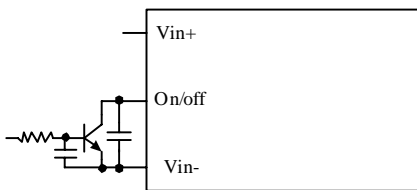

Control with open collector/drain circuit

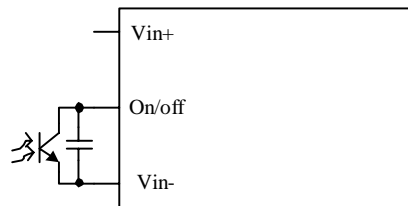

Control with photocoupler circuit

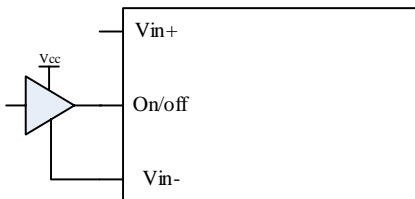

Control with logic circuit

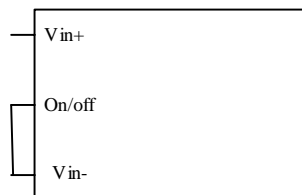

Permanently on

# ISOLATED DC/DC CONVERTERS

18 Vdc - 75 Vdc Input 12 Vdc /12 A Output, 1/4 Brick



Aug. 19, 2010

Bel Power Inc., a subsidiary of Bel Fuse Inc.

## Remote On/Off(continued)

Recommended remote on/off circuit for active high

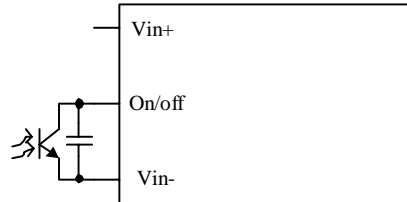
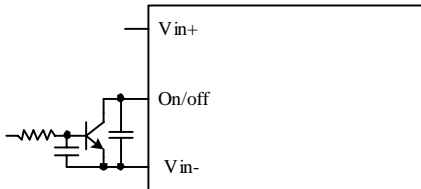

Control with open collector/drain circuit

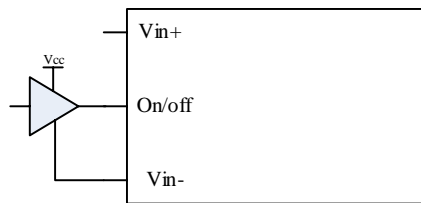

Control with photocoupler circuit

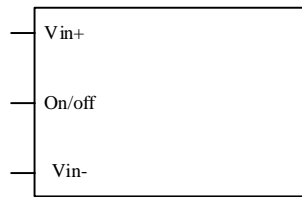

Control with logic circuit

Permanently on

## Layout

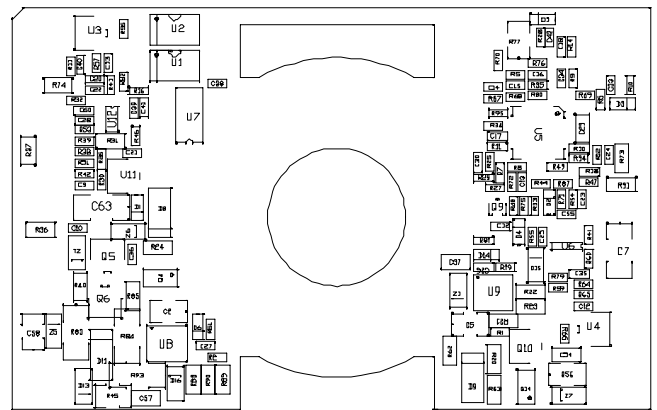
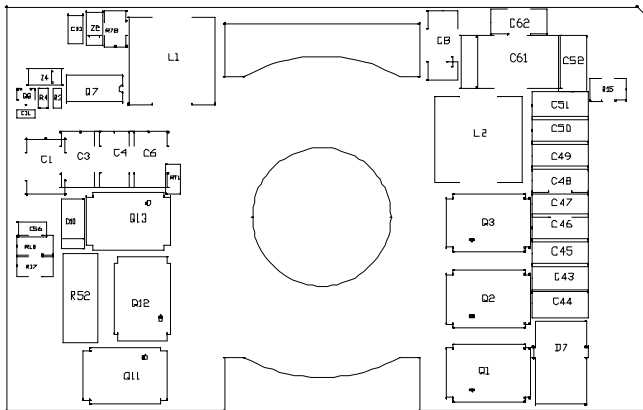

TOP VIEW

BOTTOM VIEW

Layout of components on top side

Layout of components on bottom side

# ISOLATED DC/DC CONVERTERS

18 Vdc - 75 Vdc Input 12 Vdc /12 A Output, 1/4 Brick



Aug. 19, 2010

Bel Power Inc., a subsidiary of Bel Fuse Inc.

## Output Trim Equations

Equations for calculating the trim resistor are shown below. The Trim Down resistor should be connected between the Trim pin and Sense (-) pin. The Trim Up resistor should be connected between the Trim pin and the Sense (+). Only one of the resistors should be used for any given application.

Minimum trim down voltage is 10.8V

Maximum trim up voltage is 13.2V.

The total voltage increased by trim and remote sense should not exceed 10% of the nominal output voltage.

$$R_{trimdown} = \frac{511}{|\delta|} - 10.22 [k\Omega]$$

$$R_{trimup} = \frac{(100 + \delta) \cdot V_o \cdot 5.11 - 626}{1.225 \cdot \delta} - 10.22 [k\Omega]$$

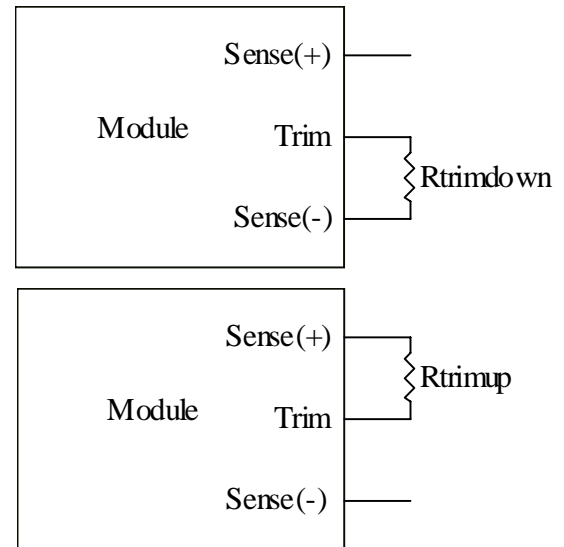

**Note:**

$$\delta = \frac{(V_o_{req} - V_o)}{V_o} \times 100 [\%]$$

$V_o_{req}$  = Desired (trimmed) output voltage [V]  
 Output voltage  $V_o$  = 12.000 V

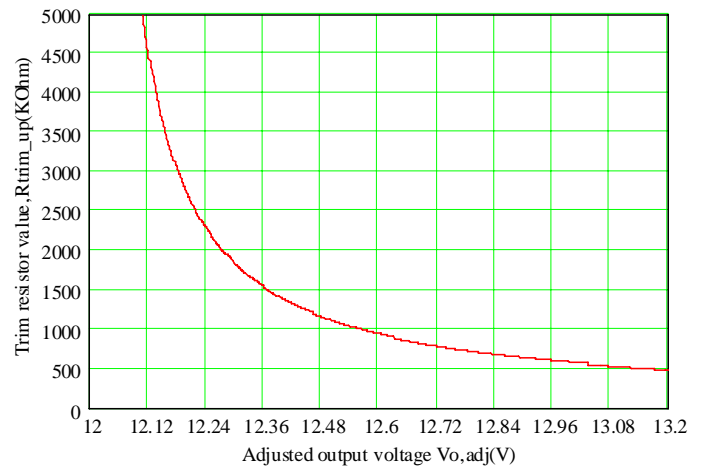
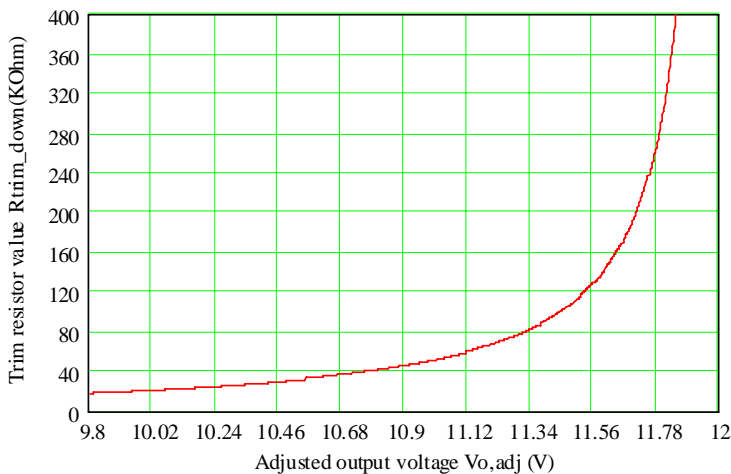

## ISOLATED DC/DC CONVERTERS

18 Vdc - 75 Vdc Input 12 Vdc /12 A Output, 1/4 Brick

**bel**

Aug. 19, 2010

*Bel Power Inc., a subsidiary of Bel Fuse Inc.*

### Remote Sense

This module has remote sense compensation feature. It can minimize the effects of resistance between module's output and load in system layout and facilitates accurate voltage regulation at load terminals or other selected point.

1. The remote sense lines carries very little current and hence do not require a large cross-sectional area.
2. This module compensates for a maximum drop of 10% of the nominal output voltage.
3. If the unit is already trimmed up, the available remote sense compensation range should be correspondingly reduced. The total voltage increased by trim and remote sense should not exceed 10% of the nominal output voltage.
4. When using remote sense compensation, all the resistance, parasitic inductance and capacitance of the system are incorporated within the feedback loop of this module. It can make an effect on the module's compensation, affecting the stability and dynamic response. A 0.1uF ceramic capacitor can be connected at the point of load to de-couple noise on the sense wires.
5. Recommend the connection of remote sense compensation as below figure. There are a resistor RS+ (100 ohm) from Vo+ to Sense+ and a resistor RS- (51 ohm)) from Vo- to Sense- inside of this module.

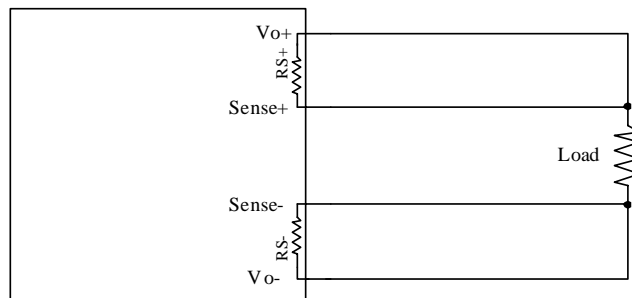

6. If not using remote sense compensation, please connect sense directly to output at module's pin, that is, connect sense+ to Vo+ and sense- to Vo- at module's pin, the shorter the better. See below figure.

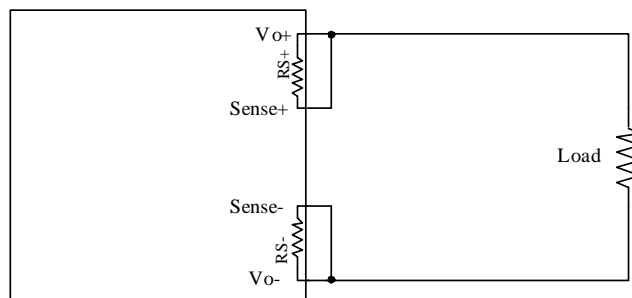

Aug. 19, 2010

*Bel Power Inc., a subsidiary of Bel Fuse Inc.*

### Over Current Protection

To provide protection in a fault output overload condition, the module is equipped with internal current-limiting circuitry and can endure current limiting for a few milli-seconds. If the over-current condition persists beyond a few milliseconds, the module will shut down into hiccup mode and restart once every 400mS. The module operates normally when the output current goes into specified range. The typical average output current is 0.5A during hiccup.

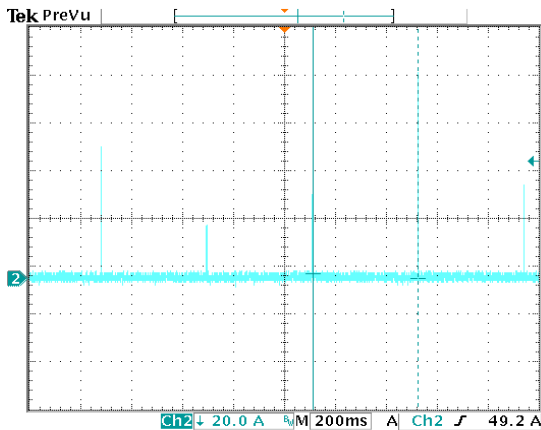

Vin=48V

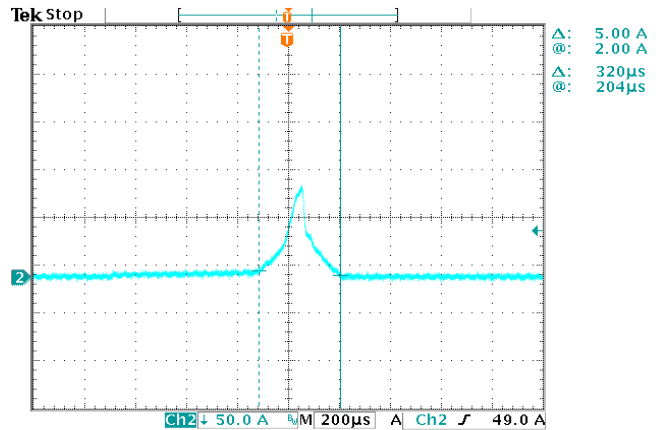

Expansion of on time portion

### Over Voltage Protection

The output over voltage protection consists of circuitry that monitors the voltage on the output terminals. If the voltage on the output terminals exceeds the over voltage protection threshold, the module will shutdown into hiccup mode and restart once every 800mS. The module operates normally when the fault is cleared.

Test setup:

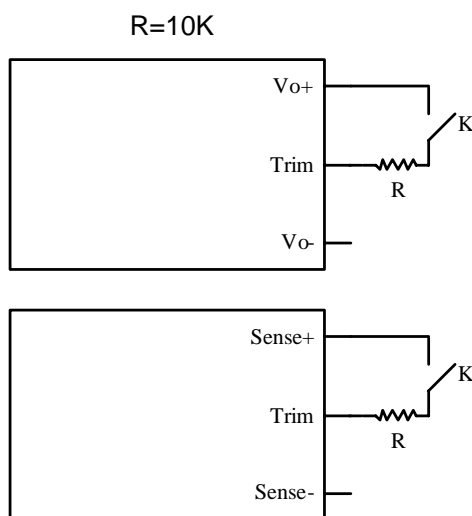

Waveform:

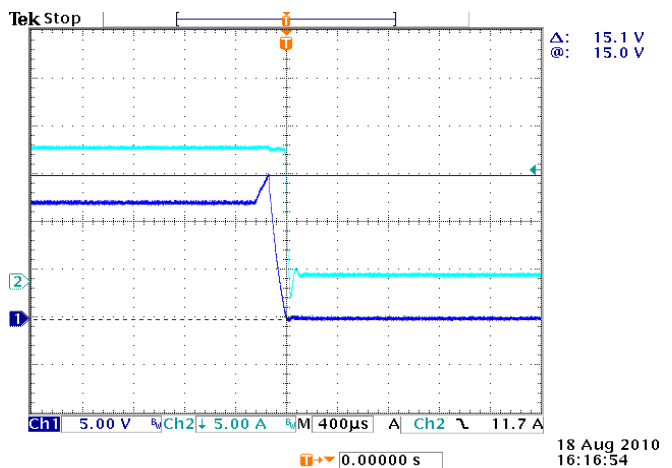

48Vin, 12A Load

CH1: Output voltage waveform  
 CH2: Output Current waveform

# ISOLATED DC/DC CONVERTERS

18 Vdc - 75 Vdc Input 12 Vdc /12 A Output, 1/4 Brick



Aug. 19, 2010

*Bel Power Inc., a subsidiary of Bel Fuse Inc.*

## Over Temperature Protection

The OTP is achieved by thermistor RT1 and the threshold is set at 120C in non-latch mode; the hottest component Q13 reaches 130C with 100LFM air flow correspondingly. It will restart automatically when the temperature falls down to 110C. The protecting point will be varied a little under different conditions (air flow, ambient temperature, input voltage, load...).

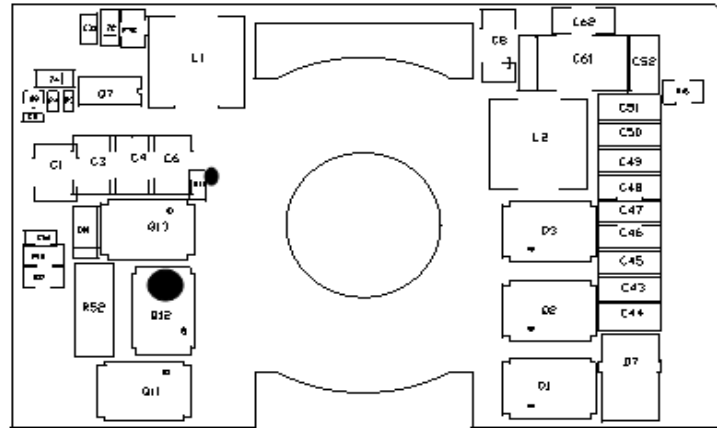

TOP VIEW

## Input Under-voltage Lockout

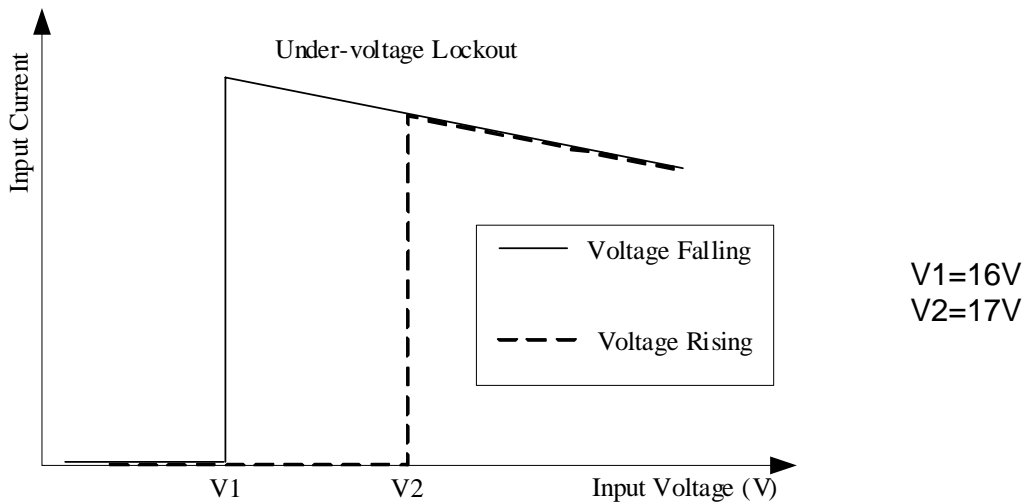

# ISOLATED DC/DC CONVERTERS

18 Vdc - 75 Vdc Input 12 Vdc /12 A Output, 1/4 Brick



Aug. 19, 2010

Bel Power Inc., a subsidiary of Bel Fuse Inc.

## Safety & EMC

### Safety

1. Material flammability UL94V-0
2. TUV Certification EN60950-1
3. UL Certification UL60950-1

### EMC

1. Surge IEC61000-4-5
2. DC-DIP IEC61000-4-29
3. Conductive EMI EN55022 class A

Compliance to EN55022 class A (both q.peak and average) with the following inductive and capacitive filter

Setup:

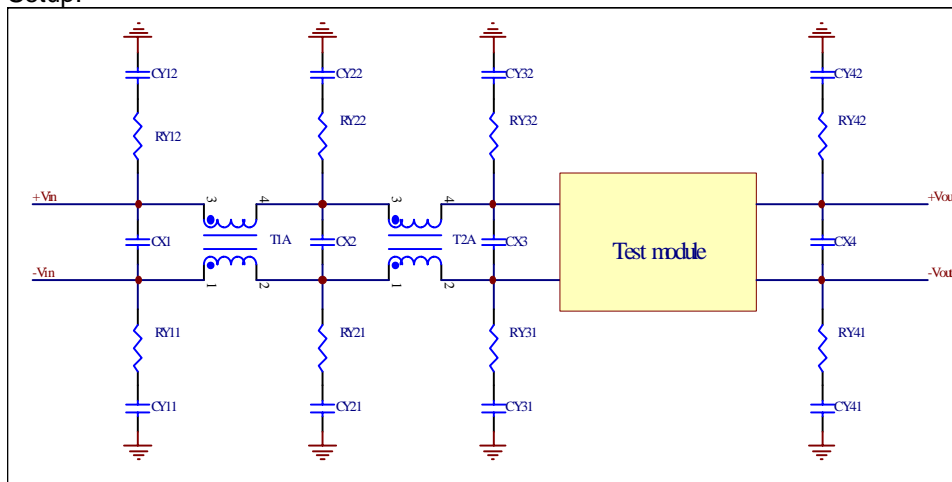

Item	Designator	Parameter	Vendor	Vendor P/N
1	CX1,CX2	2.2uF/100V,ceramic	Murata	GRF32ER72A225KA11L
2	C3X	100uF/100V, AL cap	Nichicon	UVZ2A101MPD
3	RY21,RY22	0R,0805	SEI	
4	CY21,CY22	6800pF/2000V,ceramic	Johanson	202R29W682KV4E
5	RY31,RY32	51R,0805	SEI	
6	CY31,CY32	1500pF/2000V,ceramic	Johanson	302R29W152KV4E
7	RY41,RY42	0R,0805	SEI	
8	CY41,CY42	1500pF/2000V,ceramic	Johanson	302R29W152KV4E
9	T1A	1.0mH, common mode		
10	T2A	2.2mH,common mode		

# ISOLATED DC/DC CONVERTERS

18 Vdc - 75 Vdc Input 12 Vdc /12 A Output, 1/4 Brick



Aug. 19, 2010

Bel Power Inc., a subsidiary of Bel Fuse Inc.

## Safety & EMC (continued)

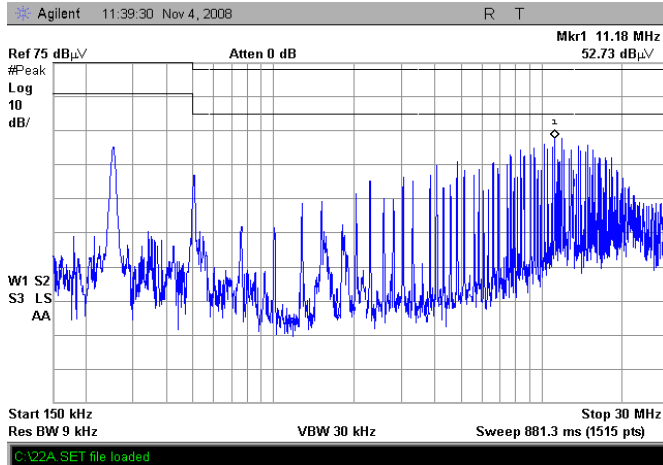

Positive

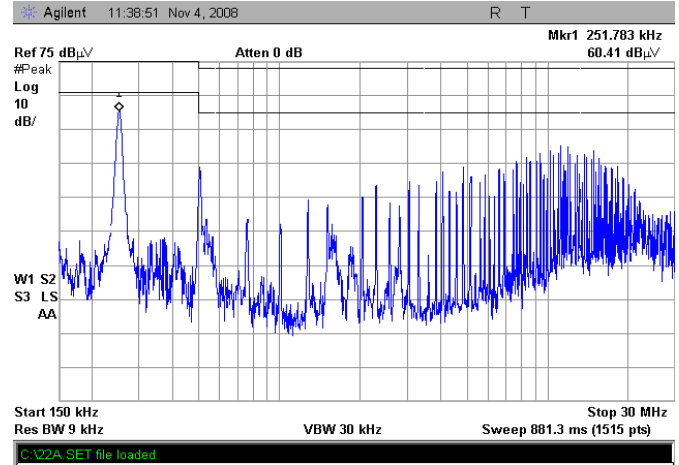

Negative

## Fundamental Circuit Diagram

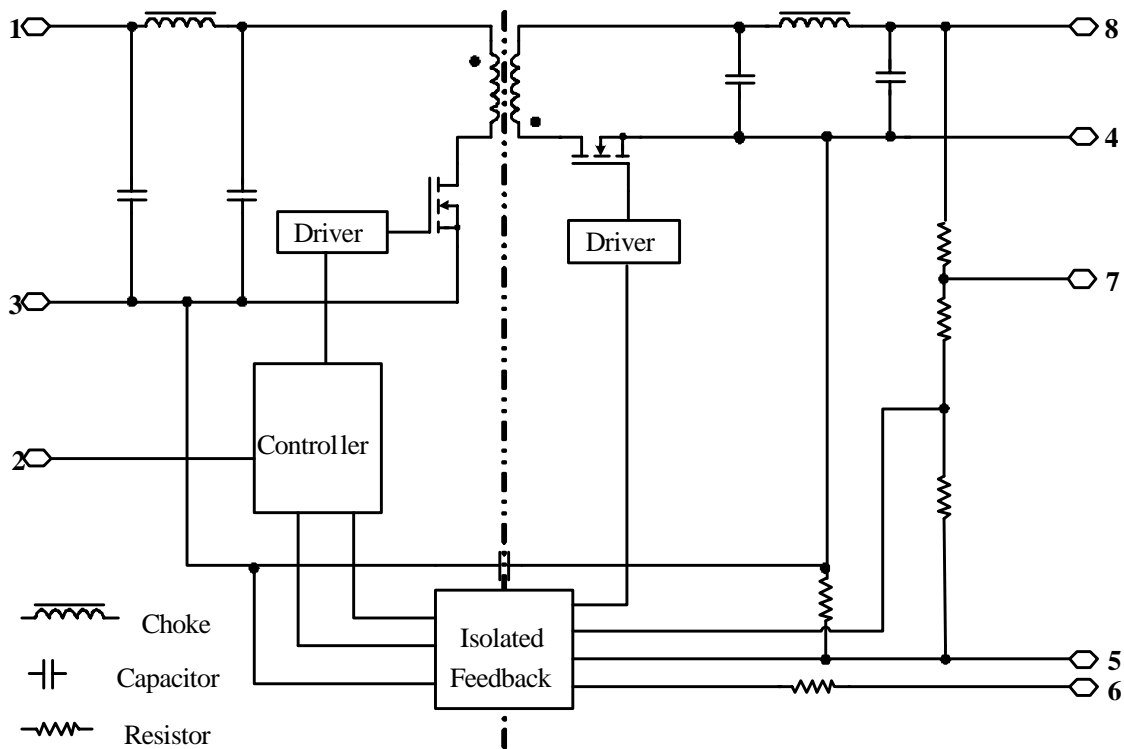



# ISOLATED DC/DC CONVERTERS

18 Vdc - 75 Vdc Input 12 Vdc /12 A Output, 1/4 Brick



Aug. 19, 2010

Bel Power Inc., a subsidiary of Bel Fuse Inc.

## Mechanical Outline

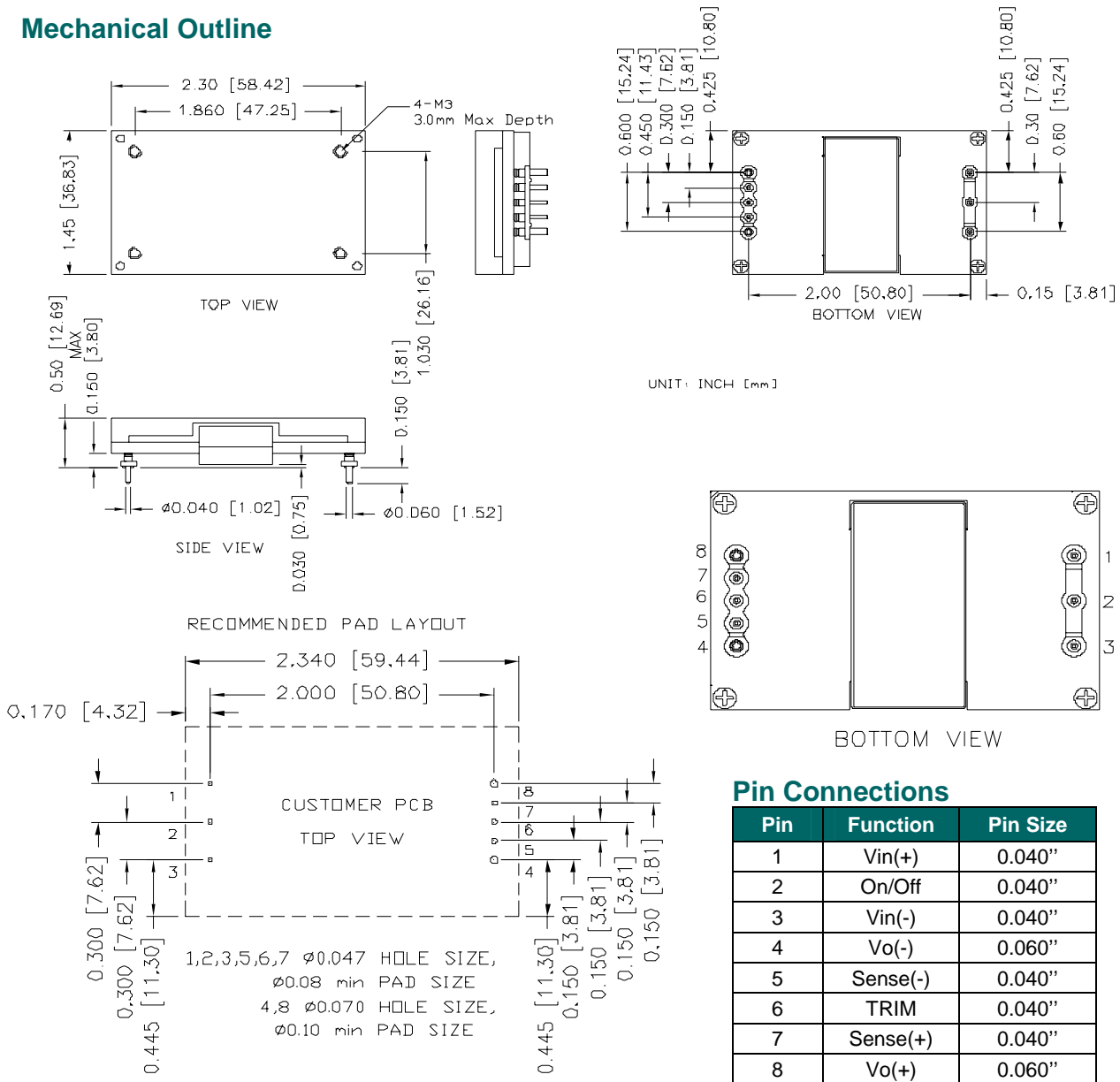

**Note: This module is recommended and compatible with Pb-Free Wave Soldering and must be soldered using a peak solder temperature of no more than 260 °C for less than 5 seconds.**

**Note:**

- 1) All Pins: Material - Copper Alloy;  
Finish – 3 micro inches minimum Gold over 50 micro inches minimum Nickel plate.
- 2) Undimensioned components are shown for visual reference only.
- 3) All dimensions in inches (mm); Tolerances: x.xx +/-0.02 in. (x.x +/-0.5mm) x.xxx +/-0.010 in. (x.xx +/-0.25mm).

## ISOLATED DC/DC CONVERTERS

18 Vdc - 75 Vdc Input 12 Vdc /17 A Output, 1/4 Brick



Aug. 19, 2010

*Bel Power Inc., a subsidiary of Bel Fuse Inc.*

### Revision History

Date	Revision	Changes Detail	Approval
2008-06-24	PA	First release	JZ Wang
2009-03-10	B	Updated MD, TR, NR and Efficiency, add TD	JZ Wang
2009-12-29	C	Update outline and MD	JZ Wang
2010-08-19	D	Add Shutup&Shutdown, Remote on/off, Layout, Remote sense, OCP, OVP, OTP, UVLO, Safety&EMC and Fundamental circuit diagram.	JZ Wang

### RoHS Compliance

Complies with the European Directive 2002/95/EC, calling for the elimination of lead and other hazardous substances from electronic products.



©2010 Bel Fuse Inc. Specifications subject to change without notice. 081910

18

#### CORPORATE

**Bel Fuse Inc.**  
206 Van Vorst Street  
Jersey City, NJ 07302  
Tel 201-432-0463  
Fax 201-432-9542  
[www.belfuse.com](http://www.belfuse.com)

#### FAR EAST

**Bel Fuse Ltd.**  
8F/ 8 Luk Hop Street  
San Po Kong  
Kowloon, Hong Kong  
Tel 852-2328-5515  
Fax 852-2352-3706  
[www.belfuse.com](http://www.belfuse.com)

#### EUROPE

**Bel Fuse Europe Ltd.**  
Preston Technology Management Centre  
Marsh Lane, Suite G7, Preston  
Lancashire, PR1 8UD, U.K.  
Tel 44-1772-556601  
Fax 44-1772-888366  
[www.belfuse.com](http://www.belfuse.com)