

### FEATURES

- ◆ 3 current-limited and short-circuit-proof push-pull drivers
- ◆ Built-in adaption to 75 Ω characteristic impedance
- ◆ High driver current of 300 mA at 24 V typ.
- ◆ Low saturation voltage up to 30 mA load current
- ◆ Short switching times and high slew rates by npn circuitry
- ◆ Wide driver supply range  $V_B = 4.5\text{ V to }30\text{ V}$
- ◆ Internal free-wheeling diodes to  $V_B$  and GND
- ◆ Schmitt trigger inputs with integrated pull-up current sources
- ◆ Inputs compatible to TTL and CMOS
- ◆ Inverting and non-inverting driver mode
- ◆ Bus capability due to Tri-State switching
- ◆ Compatible to EIA standard RS-422
- ◆ Thermal shutdown with hysteresis
- ◆ Short-circuit-proof OC error output reports thermal shutdown or undervoltage at  $V_{CC}$  or  $V_B$
- ◆ Driver disabled in case of fault
- ◆ extended temperature range of up to 130 °C in TSSOP20tp 4.4 mm package

### APPLICATIONS

- ◆ 24 V signal transfer
- ◆ Line driver in PLC environment

### PACKAGES

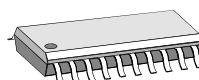

SO20

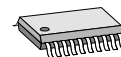

TSSOP20  
thermal pad

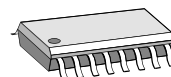

SO16W

### BLOCK DIAGRAM

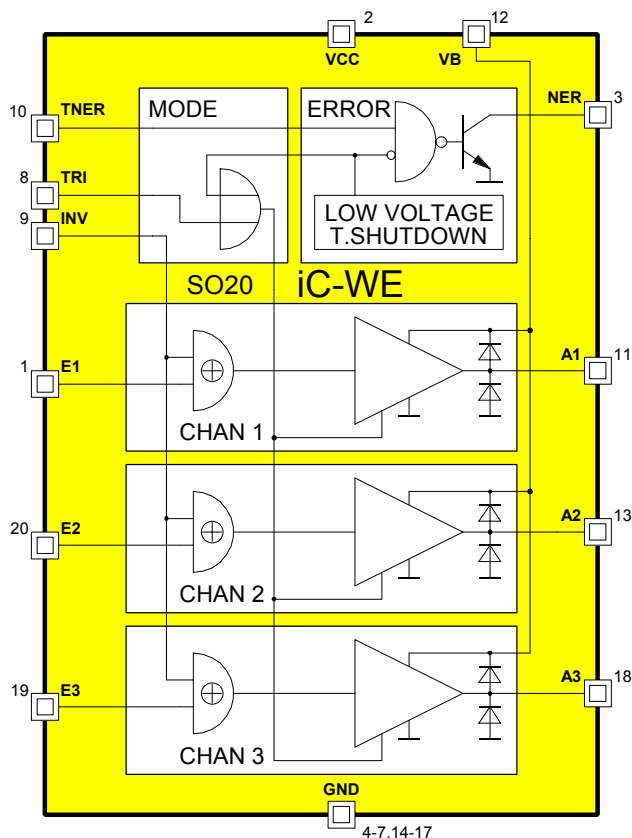

# iC-WE

## 3-CHANNEL 75 Ω LINE DRIVER



Rev D1, Page 2/10

### DESCRIPTION

The iC-WE is a high-speed monolithic line driver circuit for three independent channels with built-in characteristic impedance adaption for 75Ω lines. The push-pull outputs are designed for a high driver power of typ. 300mA at 24V. They are current-limited and short-circuit protected by thermal shut-down at over-temperature. Clamp diodes to VB and to GND protect the IC outputs against echoes of mismatched lines and against damage due to ESD according to MIL-STD-883.

All inputs are Schmitt triggers and contain current sources from the 5V supply VCC which select a defined High Level without external wiring. Clamp diodes to VCC and to GND furnish ESD protection.

Using the INVERT input it is possible to switch all channels to inverting or non-inverting operation. This enables a data transmission with balanced line activation using two iC-WE devices. For bus applications the final stages can be forced to a high impedance state using the TRI-State input.

The circuit monitors supply voltages VB and VCC as well as the chip temperature and switches all final stages to high impedance in the event of a fault. The NER output which is constructed as an open collector and is also short-circuit proof reports the fault via the connected line. The error input TNER can be linked to message outputs of other ICs and allows iC-WE to report a system fault message. If the supply voltage VCC cancels, NER becomes highly resistive.

### PACKAGES SO20, SO16W, TSSOP20 to JEDEC Standard

#### PIN CONFIGURATION, top view

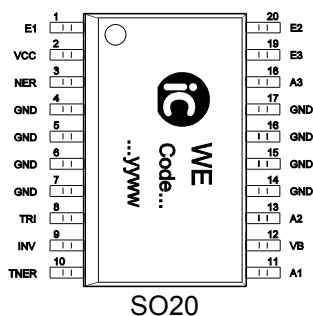

SO20

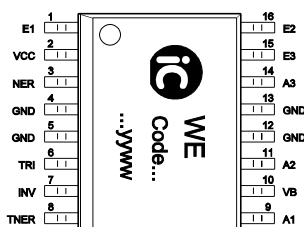

SO16W

(low power applications only)

(scale 2:1)

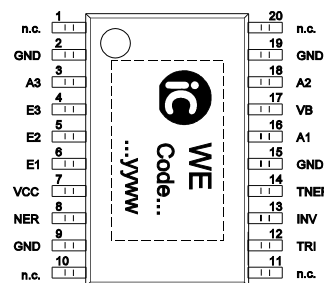

TSSOP20tp 4.4 mm

#### PIN FUNCTIONS

Name	Function	Name	Function
VCC	+5 V (± 10 %) Input Supply Voltage	VB	+4.5..+30 V Driver Supply Voltage
E1	Channel 1 Input	A1	Channel 1 Output
E2	Channel 2 Input	A2	Channel 2 Output
E3	Channel 3 Input	A3	Channel 3 Output
TRI	Tristate Input, high active	NER	Error Output, low active
INV	Invert Mode Input, high active	GND	Ground
TNER	Error Input		

To enhance heat removal, the TSSOP20 package offers a large area pad to be soldered (a connection is only permitted to GND).

# iC-WE

## 3-CHANNEL 75 Ω LINE DRIVER



Rev D1, Page 3/10

### ABSOLUTE MAXIMUM RATINGS

Values beyond which damage may occur; device operation is not guaranteed.

Item	Symbol	Parameter	Conditions	Fig.			Unit
					Min.	Max.	
G001	VCC	Supply Voltage			0	7	V
G002	VB	Driver Supply Voltage			0	32	V
G003	I(A)	Output Current in A1..3			-800	800	mA
G004	I(E)	Input Current in E1..3, INV, TRI, TNER			-4	4	mA
G005	V(NER)	Voltage at NER				32	V
G006	I(NER)	Current in NER				25	mA
E001	Vd()	ESD Susceptibility at all pins	MIL-STD-883, Method 3015, HBM 100 pF discharged through 1.5 kΩ			2	kV
TG1	Tj	Operating Junction Temperature			-40	165	°C
TG2	Ts	Storage Temperature Range			-40	150	°C

### THERMAL DATA

Operating Conditions: VB = 4.5..30 V, VCC = 5 V ± 10 %

Item	Symbol	Parameter	Conditions	Fig.				Unit
					Min.	Typ.	Max.	
T1	Ta	Operating Ambient Temperature Range (extended range to -40 °C on request)	iC-WE SO16W		-25		125	°C
			iC-WE SO20, iC-WE TSSOP20		-25		130	°C
T2	Rthja	Thermal Resistance SO20 Chip to Ambient	surface mounted with ca. 2 cm <sup>2</sup> heat sink at leads (see Demo Board)			35	45	K/W
T3	Rthja	Thermal Resistance SO16W Chip to Ambient	surface mounted with ca. 2 cm <sup>2</sup> heat sink at leads			55	75	K/W
T4	Rthja	Thermal Resistance TSSOP20 Chip to Ambient	surface mounted, thermal pad soldered to ca. 2 cm <sup>2</sup> heat sink			30	40	K/W

All voltages are referenced to ground unless otherwise noted.

All currents into the device pins are positive; all currents out of the device pins are negative.

## ELECTRICAL CHARACTERISTICS

Operating Conditions:

VB = 4.5..30 V, VCC = 5 V ± 10 %, Tj = -40..125 °C, unless otherwise noted

Item	Symbol	Parameter	Conditions	Tj °C	Fig.				Unit
						Min.	Typ.	Max.	
<b>Total Device</b>									
001	VCC	Permissible Supply Voltage Range				4.5		5.5	V
002	I(VCC)	Supply Current in VCC		-40		8	15	24	mA
				27		8	14	23	mA
				80		8	13	21	mA
				125		8	12	19	mA
003	VB	Permissible Driver Supply Voltage Range				4.5		30	V
004	I(VB)lo	Supply Current in VB	A1..3 = lo	-40		8	16	24	mA
				27		6	14	21	mA
				80		5	12	18	mA
				125		4	11	15	mA
005	I(VB)hi	Supply Current in VB	A1..3 = hi, I(A1..3) = 0	-40		7	11	14	mA
				27		6	9	12	mA
				80		4	7	10	mA
				125		3	5	8	mA
006	I(VB)Tri	Supply Current in VB, Outputs Tri-State	TRI = hi, V(A1..3) = -0.3..VB + 0.3 V	-40				1.2 1.4	mA mA
<b>Driver Outputs A1..3</b>									
101	Vs()lo	Saturation Voltage lo	I(A) = 10 mA	-40				1.15	V
				27				1.05	V
				80				1.05	V
				125				1.0	V
102	Vs()lo	Saturation Voltage lo	I(A) = 30 mA	-40				1.55	V
				27				1.5	V
				80				1.5	V
				125				1.4	V
103	Vs()hi	Saturation Voltage hi	Vs()hi = VB - V(A), I(A) = -10 mA	-40				1.1	V
				27				1.0	V
				80				1.0	V
				125				0.9	V
104	Vs()hi	Saturation Voltage hi	Vs()hi = VB - V(A), I(A) = -30 mA	-40				1.45	V
				27				1.4	V
				80				1.4	V
				125				1.3	V
105	Isc()hi	Short-Circuit Current hi	VB = 30 V, V(A) = 0			-800	-500	-300	mA
106	Isc()lo	Short-Circuit Current lo	VB = 30 V, V(A) = VB			300	500	800	mA
107	Rout()	Output Impedance	VB = 30 V, V(A) = 15 V			40	75	100	Ω
108	SR()hi	Slew-Rate hi	VB = 30 V, CL = 100 pF				250		V/μs
109	SR()lo	Slew-Rate lo	VB = 30 V, CL = 100 pF				1500		V/μs
110	I0()	Off-State Current	TRI = hi, V(A) = 0..VB			-50		50	μA
111	Vc()hi	Clamp Voltage hi	Vc()hi = V(A) - VB, TRI = hi, I(A) = 100 mA			0.4		1.5	V
112	Vc()lo	Clamp Voltage lo	TRI = hi, I(A) = -100 mA			-1.5		-0.4	V
<b>Inputs E1..3</b>									
201	Vt()hi	Threshold Voltage hi						40	%VCC
202	Vt()lo	Threshold Voltage lo				30			%VCC
203	Vt()hys	Input Hysteresis	Vhys = Vt()hi - Vt()lo			35	110		mV

# iC-WE

## 3-CHANNEL 75 Ω LINE DRIVER



Rev D1, Page 5/10

### ELECTRICAL CHARACTERISTICS

Operating Conditions:

$V_B = 4.5..30\text{ V}$ ,  $V_{CC} = 5\text{ V} \pm 10\%$ ,  $T_j = -40..125\text{ °C}$ , unless otherwise noted

Item	Symbol	Parameter	Conditions	Tj °C	Fig.				Unit
						Min.	Typ.	Max.	
<b>Inputs E1..3 (continued)</b>									
204	I <sub>pu</sub> ( )	Pull-Up Current	$V(E) = 0..V_{CC} - 1\text{ V}$			40		280	μA
205	V <sub>c</sub> ( ) <sub>hi</sub>	Clamp Voltage hi	$V_c(E)_{hi} = V(E) - V_{CC}$ , I(E) = 4 mA			0.4		1.25	V
206	V <sub>c</sub> ( ) <sub>lo</sub>	Clamp Voltage lo	I(E) = -4 mA			-1.25		-0.4	V
207	t <sub>p</sub> (E-A)	Propagation Delay E → A		80 125			200	300 330 330	ns ns ns
208	Δt <sub>p</sub> ( ) <sub>INV</sub>	Delay Skew E → A for INV = lo vs. INV = hi					25	150	ns
<b>Error Detection</b>									
301	V <sub>CCcon</sub>	Turn-on Threshold VCC				4.0		4.49	V
302	V <sub>CCcoff</sub>	Undervoltage Threshold at VCC	decreasing Supply VCC			3.8		4.30	V
303	V <sub>CChys</sub>	Hysteresis	$V_{CChys} = V_{CCcon} - V_{CCcoff}$			130			mV
304	V <sub>Bon</sub>	Turn-on Threshold VB		-40		4.0 4.0		4.49 4.6	V V
305	V <sub>Boff</sub>	Undervoltage Threshold at VB	decreasing Supply VB			3.8		4.35	V
306	V <sub>Bhys</sub>	Hysteresis	$V_{bhys} = V_{bon} - V_{boff}$			130			mV
307	V <sub>CC</sub>	Supply Voltage VCC for NER Operation				2.6		5.5	V
308	V <sub>s</sub> (NER)	Saturation Voltage lo at NER	I(NER) = 5 mA					0.7	V
309	I <sub>sc</sub> (NER)	Short-Circuit Current lo in NER	$V(NER) = 0..30\text{ V}$			5		30	mA
310	I <sub>o</sub> (NER)	Collector Off-State Current in NER	$V(NER) = 0..30\text{ V}$ , NER = off or $V_{CC} < 0.3\text{ V}$					10	μA
311	T <sub>off</sub>	Thermal Shutdown Threshold				150		175	°C
312	T <sub>on</sub>	Thermal Lock-on Threshold	decreasing temperature			125		160	°C
313	T <sub>hys</sub>	Thermal Shutdown Hysteresis	$T_{hys} = T_{off} - T_{on}$				20		°C
<b>Mode Select INV, TRI, TNER</b>									
401	V <sub>t</sub> ( ) <sub>hi</sub>	Threshold Voltage hi						40	%VCC
402	V <sub>t</sub> ( ) <sub>lo</sub>	Threshold Voltage lo				30			%VCC
403	V <sub>t</sub> ( ) <sub>hys</sub>	Input Hysteresis	$V_t(hys) = V_t(hi) - V_t(lo)$			40	90		mV
404	I <sub>pu</sub> ( )	Pull-Up Current	$V() = 0..V_{CC} - 0.8\text{ V}$			35	100	250	μA
405	V <sub>c</sub> ( ) <sub>hi</sub>	Clamp Voltage hi	$V_c(hi) = V() - V_{CC}$ , I() = 4 mA			0.4		1.25	V
406	V <sub>c</sub> ( ) <sub>lo</sub>	Clamp Voltage lo	I() = -4 mA			-1.25		-0.4	V
407	t <sub>pz</sub> (TRI-A)	Propagation Delay TRI → A (A: lo, hi → Tri-State)	R <sub>L</sub> (A) = 1 kΩ, R <sub>L</sub> (V <sub>CC</sub> , A) = 1 kΩ					5	μs
408	t <sub>p</sub> (INV-A)	Propagation Delay INV → A						5	μs
409	t <sub>p</sub> (TNER- NER)	Propagation Delay TNER → NER						5	μs

### APPLICATIONS INFORMATION

Line drivers for automation & control equipment connect digital signals with TTL or CMOS levels to 24 V systems via cables. Due to possible short-circuits, the drivers are current-limited and lock out in the event of over-temperature.

The maximum permissible signal frequency depends on the capacitive load of the outputs (cable length) or the consequential power dissipation in the iC-WE.

Except for saturation voltages, the maximum output voltage corresponds to supply voltage  $V_B$  when the output is open. Fig. 1 shows the typical DC output characteristic of a driver as a function of the load. The differential output resistance is about 75 Ω in broad ranges.

Every open-circuited input is set to high level by an internal pull-up current source; an additional interconnection with VCC enhances the interference immunity. An input can be set to low level in response to a short-circuit or a resistance (<7.5 kΩ) to GND.

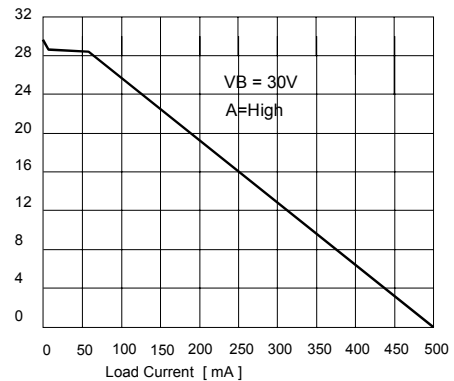

Fig. 1: Influence of load on output voltage

### LINE EFFECTS

In PLC systems, data transmission with 24 V signals is generally conducted without a line termination with the characteristic impedance. A mismatched line end produces reflections which travel back and forth if there is no line adapter at the driver end either. The transmission is disrupted in case of high-speed pulse trains.

In the iC-WE, signal reflection is prevented by an integrated characteristic impedance adapter, as shown in Fig. 2.

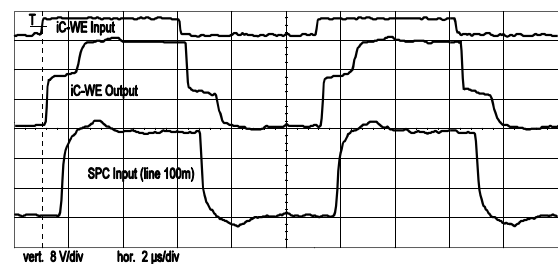

Fig. 2: Reflections due to open line end

During a pulse transmission the amplitude at the output of the iC-WE initially only increases to about one half the level of supply voltage  $V_B$  since the internal resistance of the driver and the line characteristic impedance form a voltage divider. A wave with this amplitude is injected into the line and experiences a total reflection at the high impedance end of the line following a delay based on the length of the cable. The open or high impedance terminated end of the line exhibits a voltage maximum with double amplitude since outgoing and reflected wave are superimposed.

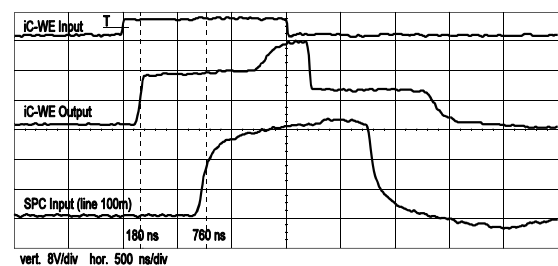

Fig. 3: Pulse transmission and transit times

Following a further delay the reflected wave also increases the driver output to twice the amplitude of the wave initially injected, possibly capped by the integrated diode suppressor circuit. The integrated characteristic impedance adaption in the iC-WE prevents another reflection and the voltage achieved is maintained along and at the end of the line.

A mismatch between the iC-WE and the line influences the level of the initially injected wave and produces reflections at the driver end. The output signal may have a number of graduations. Nonetheless, lines with characteristic impedances in the range 40 to 150 Ω permit satisfactory transmissions.

Fig. 3 shows the transmission of a short pulse of 1.5 μs. The signal delay to the end of the cable (here 100 m) is markedly longer than the transit time in the iC-WE driver.

# iC-WE

## 3-CHANNEL 75 Ω LINE DRIVER

### EXAMPLE 1: Balanced data transmission over twisted-pair cables

For balanced data transmission two iC-WE devices can be operated in parallel at the inputs with different programming of the individual INVERT input. The OC error outputs NER are linked for the system fault message.

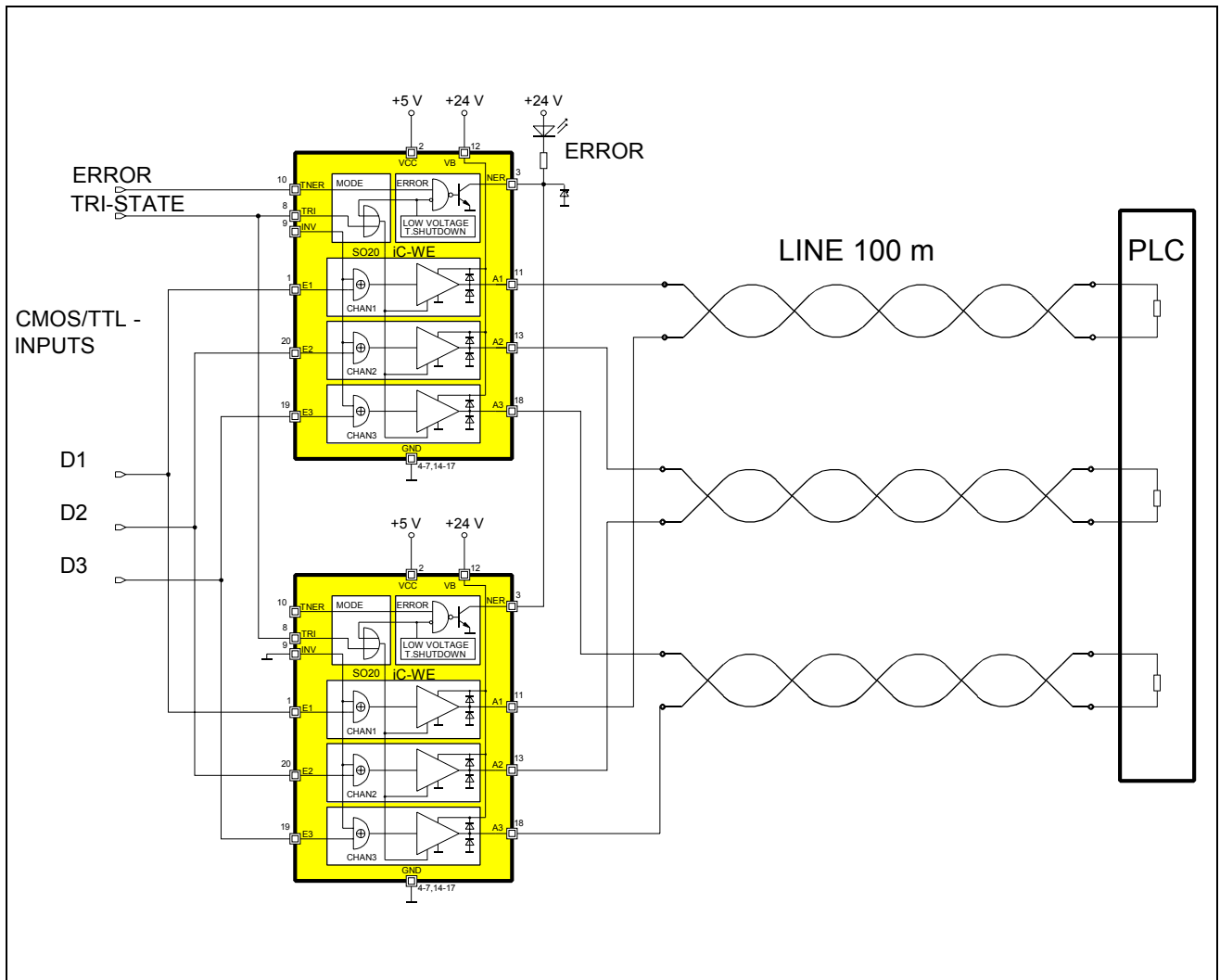

Fig. 4: Balanced data transmission

### EXAMPLE 2: Incremental encoder

Fig. 5 shows the iC-WE being used in an optical encoder system together with the iC-Haus incremental encoder iC-WT.

The iC-WT device is an evaluating IC for photodiode arrays used in incremental lengths and angle measuring systems. It preprocesses the sensor signals for transmission with line driver iC-WE. At the receive end the programmable logic controller (PLC) interface can be via optocoupler.

The preprocessed sensor signals are transmitted over cable by the iC-WE with asymmetrical activation. A high interference immunity is achieved as a result of the high output amplitude and the integrated characteristic adaption of the iC-WE.

The 24 V power supply is conducted over the cable from the PLC end. A voltage regulator generates the 5 V supply to the encoder system. It is favourable to use the iC-WD switching regulator device instead of a conventional voltage regulator. This switched-mode power supply IC operates from 8 to 30 V input voltage and contains two 5 V post regulators. Analog and digital devices can thus receive separate supply voltages.

# iC-WE

## 3-CHANNEL 75 Ω LINE DRIVER

The error input TNER on the iC-WE can be utilized to conduct a fault signal from the incremental encoder to the output NER and then to the receiver.

For protection against voltage peaks from the cable, the state input TRI is wired to the RC combination R1, R2 and C5, which can be dimensioned for levels of up to 30 V at the PLC.

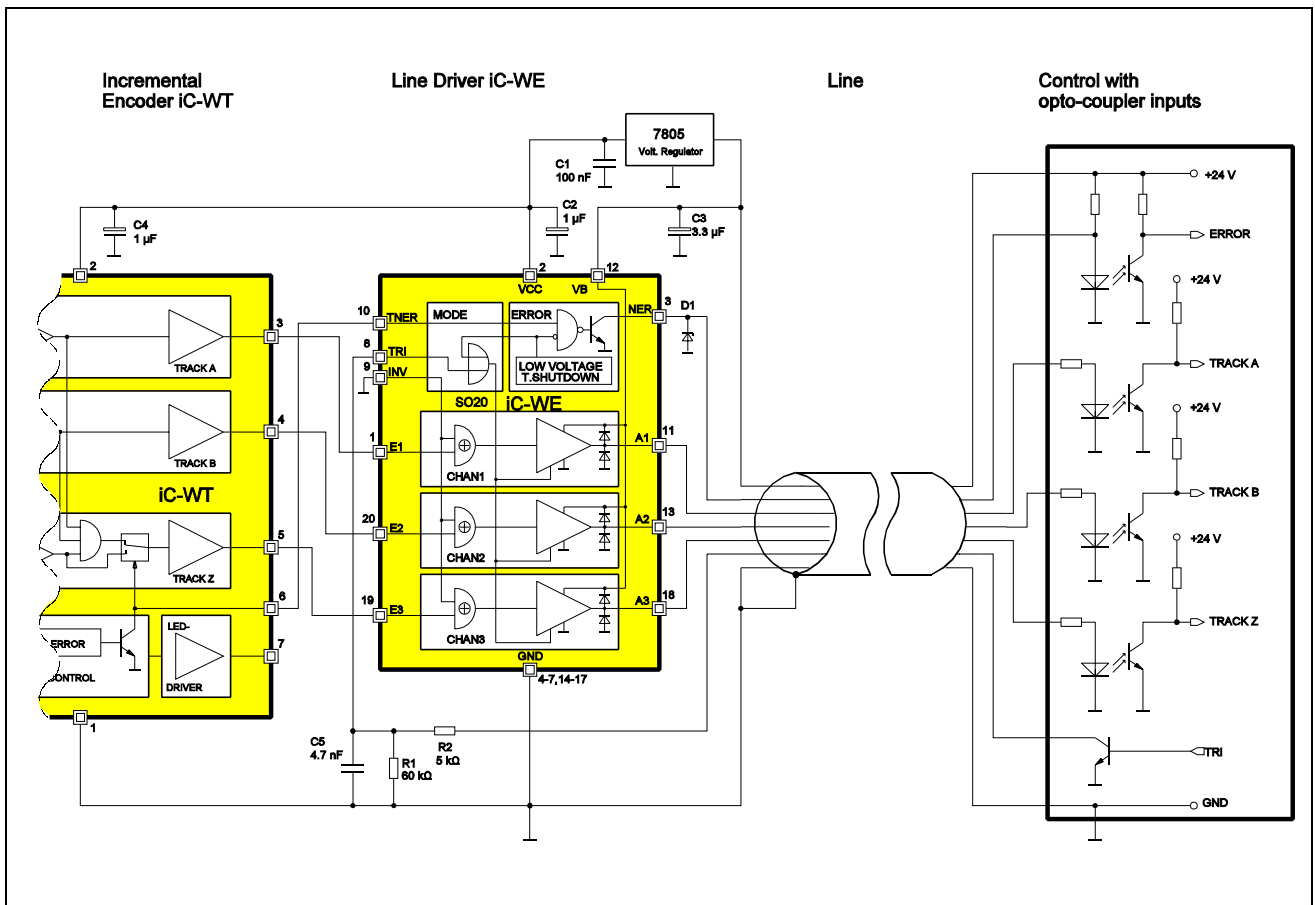

Fig. 5: Line driver iC-WE in the incremental encoder

### PRINTED CIRCUIT BOARD LAYOUT

The iC-WE's 8 GND terminals (pins 4-7 and 14-17) simultaneously function as thermal conductors and must be soldered to copper tracks with the greatest possible area of the PCB to ensure proper heat dissipation. Blocking capacitors to smooth the local IC supply voltages must be connected to VCC, VB and GND pins at the shortest possible intervals. C1 on the regulator in Fig. 3 is only necessary if the voltage regulator is more than about 3 cm away from the other ICs. C3 should not be less than 1  $\mu\text{F}$  in order to block the 24 V supply.



# iC-WE

## 3-CHANNEL 75 Ω LINE DRIVER

### DEMO BOARD

The device iC-WE with SO20 package is equipped with a Demo Board for test purposes. Figures 6 to 8 show the wiring as well as the top and bottom layout of the test PCB.

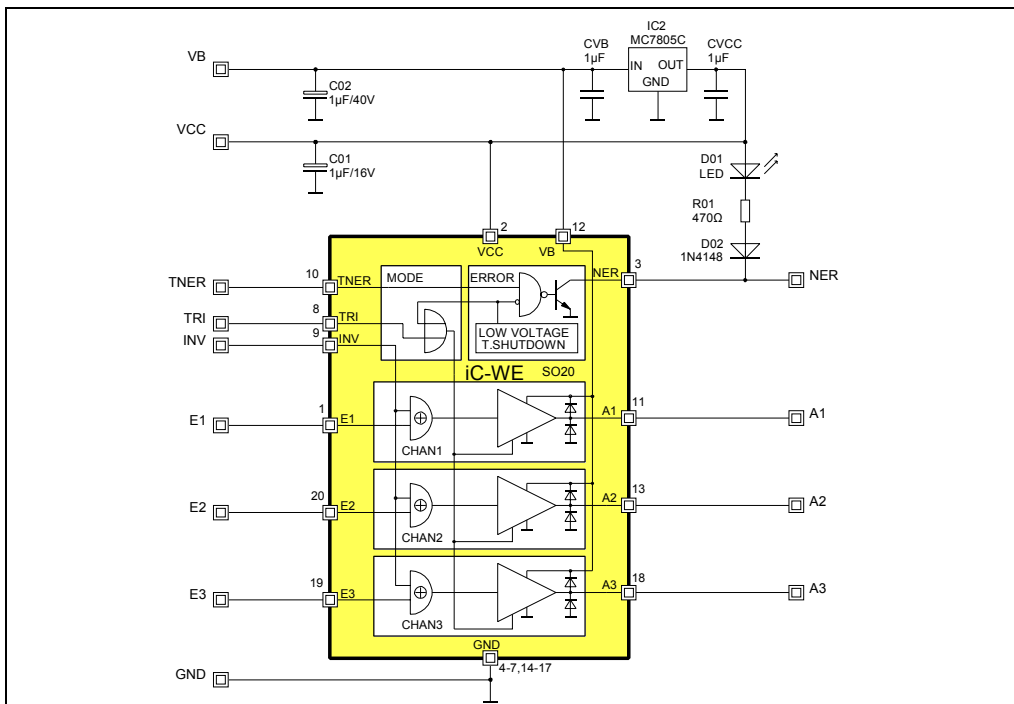

Fig. 6: Schematic diagram of the Demo Board

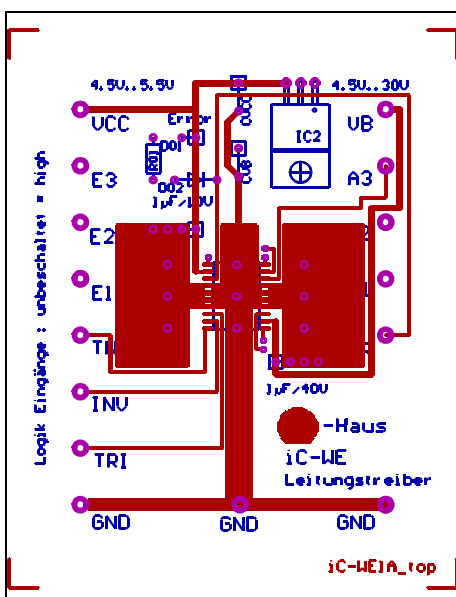

Fig. 7: Demo Board (components side)

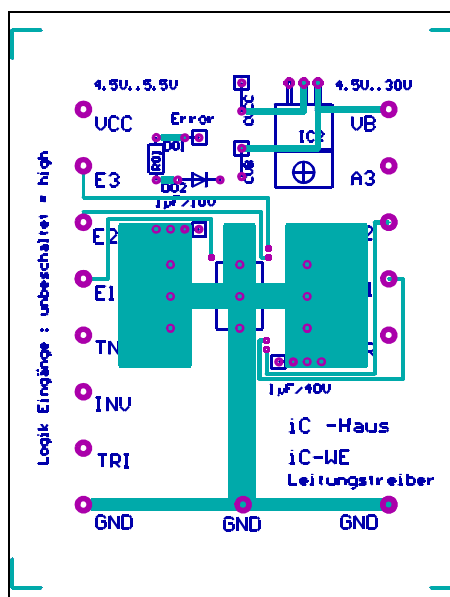

Fig. 8: Demo Board (solder dip side)

This specification is for a newly developed product. iC-Haus therefore reserves the right to modify data without further notice. Please contact us to ascertain the current data. The data specified is intended solely for the purpose of product description and is not to be deemed guaranteed in a legal sense. Any claims for damage against us - regardless of the legal basis - are excluded unless we are guilty of premeditation or gross negligence.

We do not assume any guarantee that the specified circuits or procedures are free of copyrights of third parties.

Copying - even as an excerpt - is only permitted with the approval of the publisher and precise reference to source.

**ORDERING INFORMATION**

Type	Package	Order designation
iC-WE	SO20	iC-WE SO20
	SO16W	iC-WE SO16W
	TSSOP20tp 4.4 mm	iC-WE TSSOP20
WE Demo Board		WE DEMO

For information about prices, terms of delivery, options for other case types, etc., please contact:

**iC-Haus GmbH**  
**Am Kuemmerling 18**  
**D-55294 Bodenheim**  
**GERMANY**

**Tel +49-6135-9292-0**  
**Fax +49-6135-9292-192**  
**<http://www.ichaus.com>**