

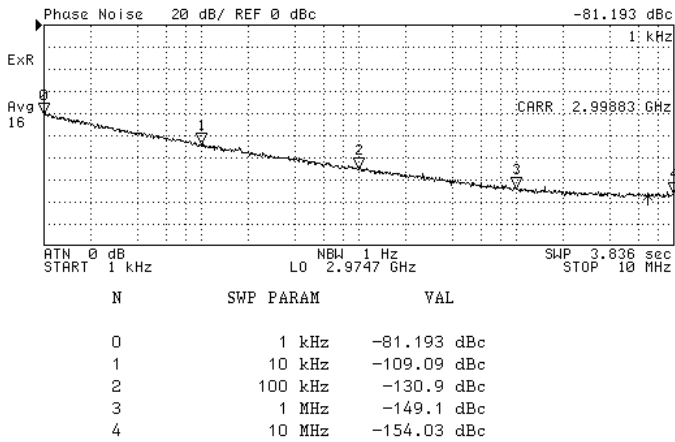

PERFORMANCE SPECIFICATION	MIN	TYP	MAX	UNITS
Lower Frequency:			3000	MHz
Upper Frequency:	3170			MHz
Tuning Voltage:	0.5		15.0	VDC
Supply Voltage:	7.6	8.0	8.4	VDC
Output Power:	+3.0	+5.0	+7.0	dBm
Supply Current:		25	35	mA
Harmonic Suppression (2 nd Harmonic):		-15	-10	dBc
Pushing:		0.5	1.0	MHz/V
Pulling, all Phases:		3.0	5.0	MHz pk-pk
Tuning Sensitivity:		20		MHz/V
Phase Noise @ 10kHz offset:		-109	-106	dBc/Hz
Phase Noise @ 100kHz offset:		-130	-128	dBc/Hz
Load Impedance:		50		Ω
Input Capacitance:			22	pF
Operating Temperature Range:	-40		+85	$^{\circ}$ C
Storage Temperature Range:	-45		+90	$^{\circ}$ C

Phase Noise (1 Hz BW, Typical)



Tuning Curve (Typical)

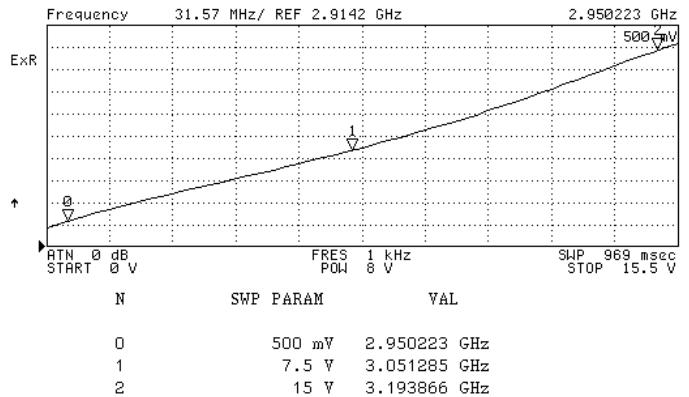

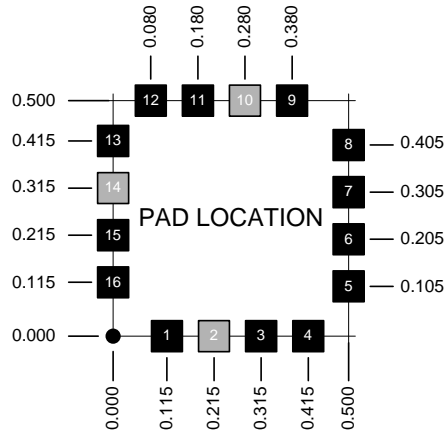
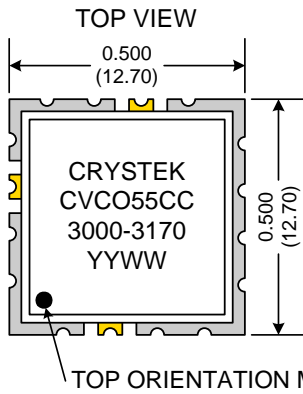
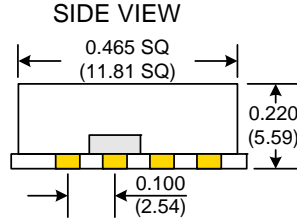
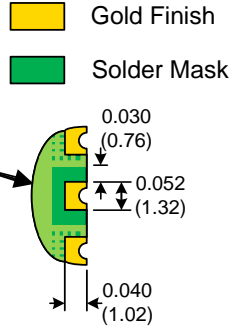
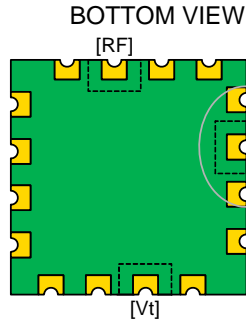

Pad	Connection
2	Vt
10	RF-OUTPUT
14	Vcc
Others	GROUND

- Unless otherwise specified, Dimensions are in: $\frac{IN}{(mm)}$
- Pad Location Dimensions are in: Inches

TAPE AND REEL

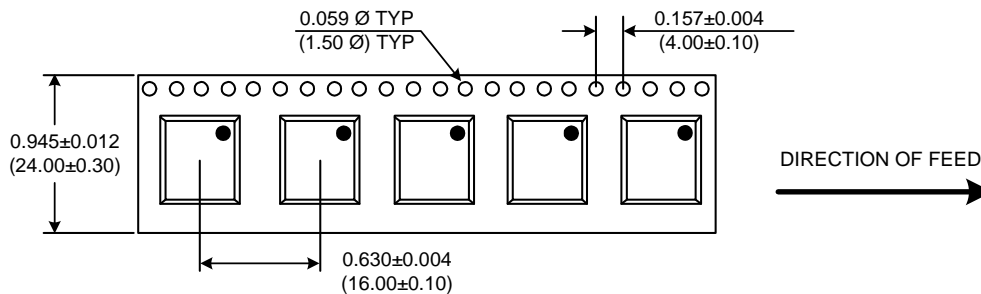

Drawing not to scale

Product Control:

Crystek Part Number:	CVCO55CC-3000-3170	Release Date:	19-Feb-08
Revision Level:	D	Responsible:	C. Vales

Specification is subject to change without notice

Page 2 of 2