

**PLEASE CHECK WWW.MOLEX.COM FOR LATEST PART INFORMATION**

**Part Number:** [0878335019](#)  
**Status:** **Active**  
**Overview:** milligrd  
**Description:** 2.00mm (.079") Pitch Milli-Grid™ Header, Right Angle, Fully Shrouded, Lead-free, 50 Circuits, Gold (Au) Flash Plating, without PCB Locator, without Locking Window, Center Polarization Slot, Tube

**Documents:**

[3D Model](#) [Product Specification PS-87831-027 \(PDF\)](#)  
[Drawing \(PDF\)](#) [RoHS Certificate of Compliance \(PDF\)](#)

**General**

Product Family	PCB Headers
Series	<a href="#">87833</a>
Application	Wire-to-Board
Comments	Contact Molex for application in automotive industry
Overview	<a href="#">milligrd</a>
Product Name	Milli-Grid™

**Physical**

Breakaway	No
Circuits (Loaded)	50
Circuits (maximum)	50
Color - Resin	Black
Durability (mating cycles max)	100
First Mate / Last Break	No
Glow-Wire Compliant	No
Guide to Mating Part	No
Keying to Mating Part	None
Lock to Mating Part	None
Material - Metal	Phosphor Bronze
Material - Plating Mating	Gold
Material - Plating Termination	Tin
Material - Resin	Nylon
Number of Rows	2
Orientation	Right Angle
PC Tail Length (in)	0.085 In
PC Tail Length (mm)	2.16 mm
PCB Locator	No
PCB Retention	None
PCB Thickness Recommended (in)	0.062 In
PCB Thickness Recommended (mm)	1.60 mm
Packaging Type	Tube
Pitch - Mating Interface (in)	0.079 In
Pitch - Mating Interface (mm)	2.00 mm
Pitch - Term. Interface (in)	0.079 In
Pitch - Term. Interface (mm)	2.00 mm
Plating min: Mating (µin)	2
Plating min: Mating (µm)	0.05
Plating min: Termination (µin)	75
Plating min: Termination (µm)	1.88
Polarized to Mating Part	Side Slots (2)
Polarized to PCB	No
Shrouded	Fully
Stackable	No
Surface Mount Compatible (SMC)	Yes

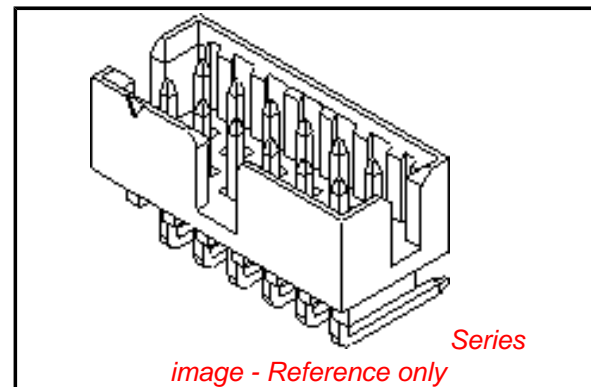

image - Reference only

**EU RoHS**

**ELV and RoHS Compliant**  
**REACH SVHC Contains SVHC: No**  
**Halogen-Free Status**

**China RoHS**



**Not Reviewed**

**Need more information on product environmental compliance?**

Email [productcompliance@molex.com](mailto:productcompliance@molex.com)  
 For a multiple part number RoHS Certificate of Compliance, [click here](#)

Please visit the [Contact Us](#) section for any non-product compliance questions.

**Search Parts in this Series**

[87833Series](#)

**Mates With**

[50394](#) Wire-to-Board Terminals. [51110](#) Wire-to-Board Crimp Housing. [87568](#) Wire-to-Board IDT Housings. [79107](#) Board-to-Board Top Entry Through Hole Receptacle. [79108](#) Board-to-Board FFC/FPC Top Entry Through Hole Receptacle. L

Temperature Range - Operating -55°C to +105°C  
Termination Interface: Style Through Hole

**Electrical**

Current - Maximum per Contact 2A  
Voltage - Maximum 125V

**Material Info**

**Reference - Drawing Numbers**

Product Specification PS-87831-027

This document was generated on 05/25/2010

**PLEASE CHECK [WWW.MOLEX.COM](http://WWW.MOLEX.COM) FOR LATEST PART INFORMATION**

10 9 8 7 6 5 4 3 2 1

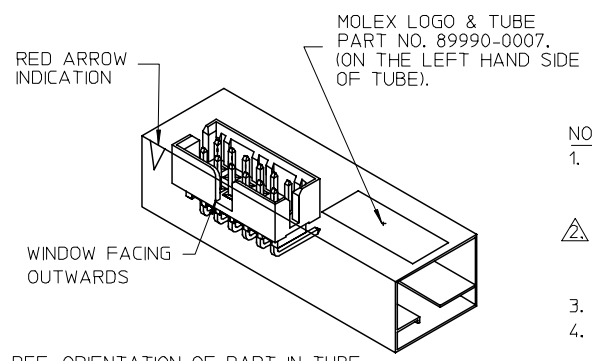
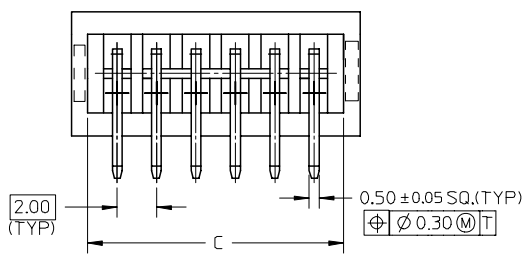
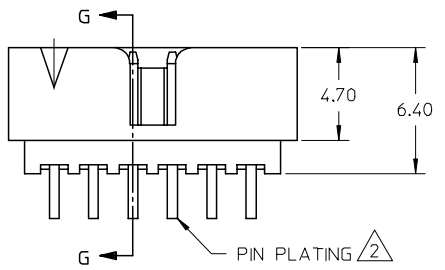
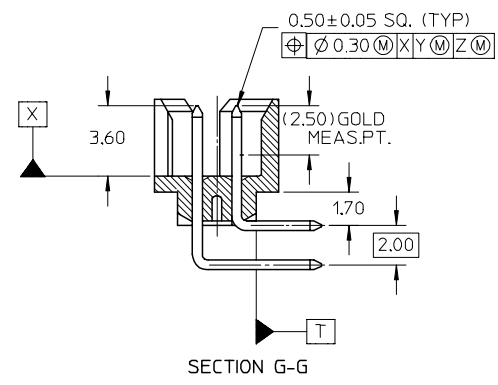
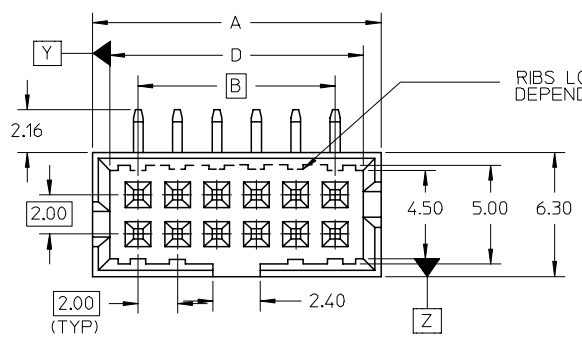

REF: ORIENTATION OF PART IN TUBE.  
(FOR THE REFERENCE OF PART/TUBE ASSEMBLY.)

PART NO.	CKT SIZE	DIMENSION			
		A	B	C	D
87833-0419	4	6.65	2.00	5.00	4.85
87833-0619	6	8.65	4.00	7.00	6.85
87833-0819	8	10.65	6.00	9.00	8.85
87833-1019	10	12.65	8.00	11.00	10.85
87833-1219	12	14.65	10.00	13.00	12.85
87833-1419	14	16.65	12.00	15.00	14.85
87833-1619	16	18.65	14.00	17.00	16.85
87833-1819	18	20.65	16.00	19.00	18.85
87833-2019	20	22.65	18.00	21.00	20.85
87833-2219	22	24.65	20.00	23.00	22.85
87833-2419	24	26.65	22.00	25.00	24.85
87833-2619	26	28.65	24.00	27.00	26.85
87833-2819	28	30.65	26.00	29.00	28.85
87833-3019	30	32.65	28.00	31.00	30.85
87833-3219	32	34.65	30.00	33.00	32.85
87833-3419	34	36.65	32.00	35.00	34.85
87833-3619	36	38.65	34.00	37.00	36.85
87833-3819	38	40.65	36.00	39.00	38.85
87833-4019	40	42.65	38.00	41.00	40.85
87833-4219	42	44.65	40.00	43.00	42.85
87833-4419	44	46.65	42.00	45.00	44.85
87833-4619	46	48.65	44.00	47.00	46.85
87833-4819	48	50.65	46.00	49.00	48.85
87833-5019	50	52.65	48.00	51.00	50.85

NOTES:

- MATERIAL :  
HOUSING : 30% G.F., NYLON 46, UL94V-0. COLOR BLACK.  
PIN : 0.50MM SQ. PHOSPHOR BRONZE.
- PLATING :  
(2 - 5)um/ (0.05 - 0.13)uin GOLD IN CONTACT AREA AND 1.88um/75uin MIN. TIN IN SOLDER TAIL AREA OVER 1.25um/50uin MIN. NICKEL OVERALL.
- PRODUCT SPECIFICATION PS-87831-027 APPLIES.
- THIS HEADER MATES WITH MOLEX:  
a) CRIMP RECEPTACLE HOUSING, 51110 SERIES WITH CRIMP TERMINAL, 50394 SERIES.  
b) 2MM MILLIGRID DUAL ROW IDT, 87568 SERIES.
- PARTS TO BE PACKED IN TUBE WITH MOISTURE BARRIER BAG

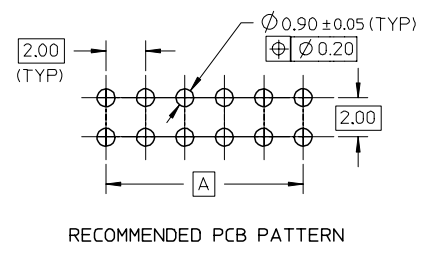

ADD MOIST BAG NOTE EC NO: S2007-0931 DRWN:GIVENARLY CHKD:SKANG APPR:MLONG	REV	DESCRIPTION	QUALITY SYMBOLS
	A5		▽=0 ▽C=0

GENERAL TOLERANCES (UNLESS SPECIFIED)	
	ANGULAR ± 3 °
	DRAFT WHERE APPLICABLE MUST REMAIN WITHIN DIMENSIONS

DIMENSION STYLE	
MM ONLY	
DRAWN BY	DATE
ATSEE	2003/10/27
CHECKED BY	DATE
KCLING	2003/11/07
APPROVED BY	DATE
SKTOH	2003/11/07
MATERIAL NO.	DOCUMENT NO.
SEE TABLE	SD-87833-013

SCALE	DESIGN UNITS	THIRD ANGLE PROJECTION
NTS	METRIC	
TITLE		
MGRID, SHROUDED HEADER WITH SLOTS AND STANDOFF R/A		
MOLEX MOLEX INCORPORATED		
SHEET NO.		1 OF 1

9 8 7 6 5 4 3 2 1