

PLEASE CHECK WWW.MOLEX.COM FOR LATEST PART INFORMATION

Part Number: [0754652104](#)
Status: **Active**
Overview: [gbx_backplane_connector_system](#)
Description: 1.85mm by 1.85mm (.073" by .073") Pitch 4-Pair GbX® Backplane L-Series Connector System, Left Guide Header, 110 Circuits, Gold (Au) 0.76µm (30µ"), Pin Length 4.55mm (.179")

Documents:

[Drawing \(PDF\)](#) [RoHS Certificate of Compliance \(PDF\)](#)
[Product Specification PS-75221-999 \(PDF\)](#)

Agency Certification

UL E29179

General

Product Family Backplane Connectors
 Series [75465](#)
 Application Backplane
 Application Tooling Documents [Tooling Manual](http://www.molex.com/pdm_docs/ats/TM-622022099.pdf)
 Comments Left Guide Header, No Keying Position
 Component Type PCB Header
 Overview [gbx_backplane_connector_system](#)
 Product Name GbX®
 Style N/A

Physical

Circuits (Loaded) 110
 Circuits (maximum) 110
 Color - Resin Gray (Dark)
 Durability (mating cycles max) 200
 First Mate / Last Break No
 Flammability 94V-0
 Guide to Mating Part Yes
 Keying to Mating Part None
 Material - Metal High Performance Alloy (HPA), Stainless Steel
 Material - Plating Mating Gold
 Material - Plating Termination Tin-Lead
 Material - Resin High Temperature Thermoplastic
 Number of Columns 10
 Number of Pairs 4
 Number of Rows 11
 Orientation Vertical
 PC Tail Length (in) 0.091 In
 PC Tail Length (mm) 2.30 mm
 PCB Locator No
 PCB Retention Yes
 PCB Thickness Recommended (in) 0.063 In
 PCB Thickness Recommended (mm) 1.60 mm
 Packaging Type Tray
 Pitch - Mating Interface (in) 0.073 In
 Pitch - Mating Interface (mm) 1.85 mm
 Pitch - Term. Interface (in) 0.073 In
 Pitch - Term. Interface (mm) 1.85 mm
 Plating min: Mating (µin) 30
 Plating min: Mating (µm) 0.76

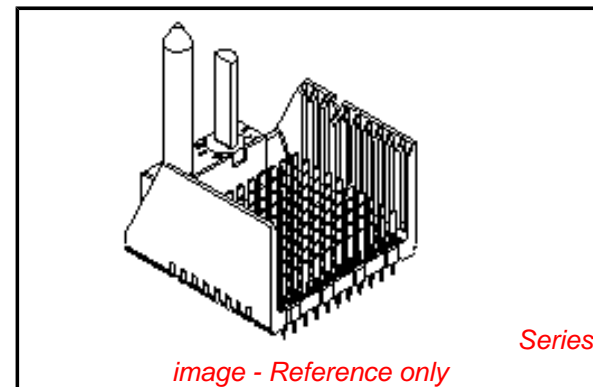

EU RoHS

RoHS Compliant by Exemption

REACH SVHC

Not Reviewed

Halogen-Free

Status

Not Reviewed

China RoHS



Need more information on product environmental compliance?

Email productcompliance@molex.com
 For a multiple part number RoHS Certificate of Compliance, [click here](#)

Please visit the [Contact Us](#) section for any non-product compliance questions.

Search Parts in this Series

[75465Series](#)

Mates With

GbX® Daughtercards [75420](#) , [75426](#)

Application Tooling | FAQ

Tooling specifications and manuals are found by selecting the products below. Crimp Height Specifications are then contained in the Application Tooling Specification document.

Global

Description	Product #
GbX® Backplane 4 Pair By 10 Wide L Series Insertion Tool	0622022025
GbX® Single Pin Repair Tool	0622022090

Plating min: Termination (μ in)	30
Plating min: Termination (μ m)	0.76
Polarized to PCB	No
Stackable	No
Surface Mount Compatible (SMC)	Yes
Temperature Range - Operating	105°C
Termination Interface: Style	Through Hole - Compliant Pin

Electrical

Current - Maximum per Contact	1A
Data Rate	8.0 Gbps
Real Signals (per 25mm)	149
Shield Type	N/A
Shielded	No
Voltage - Maximum	120V AC (RMS)/DC

Material Info

Reference - Drawing Numbers

Packaging Specification	PK-70873-563
Product Specification	PS-75221-999
Sales Drawing	SD-75465-210

GbX is a registered trademark of Amphenol Corporation.

This document was generated on 05/14/2010

PLEASE CHECK WWW.MOLEX.COM FOR LATEST PART INFORMATION

20 19 18 17 16 15 14 13 12 11 75465 9 8 7 6 5 4 3 2 1

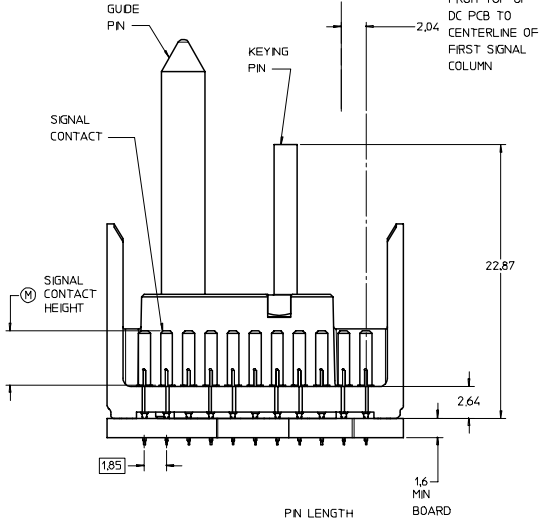
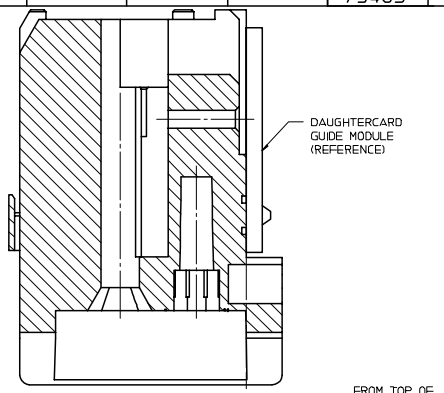
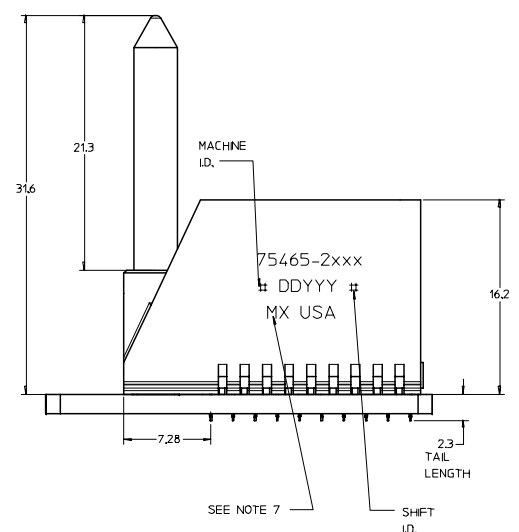
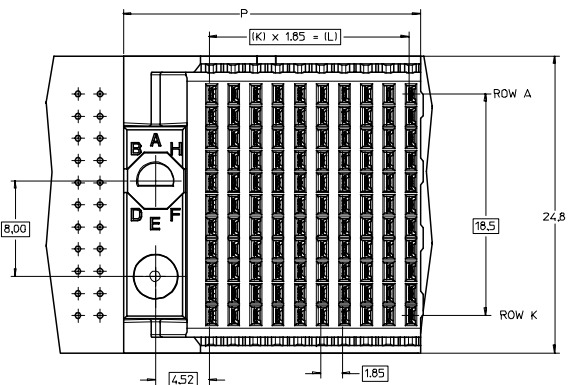

PN LENGTH DM "M"

3	3.55 mm (30H Au)
4	4.55 mm (30H Au)
5	5.55 mm (30H Au)
7	3.55 mm (50H Au)
8	4.55 mm (50H Au)
9	5.55 mm (50H Au)

KEYING POSITION NONE = 0
1 = A
2 = B
ETC.

PART NUMBER TABLE

ASSY PART NO.	K	L	P	TOTAL NO. OF CONTACTS
75465-21**	9	16.65	24.78	110
75465-22**	24	44.40	52.53	275
75465-25**	4	7.40	15.53	55

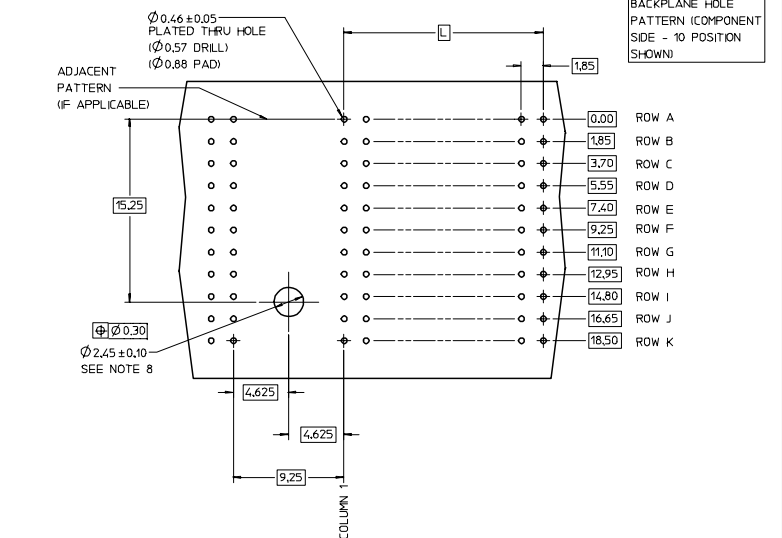

P/N	0	1	2	3	4	5	6	7	8
75465-1									
KEYING PIN ORIENTATION									

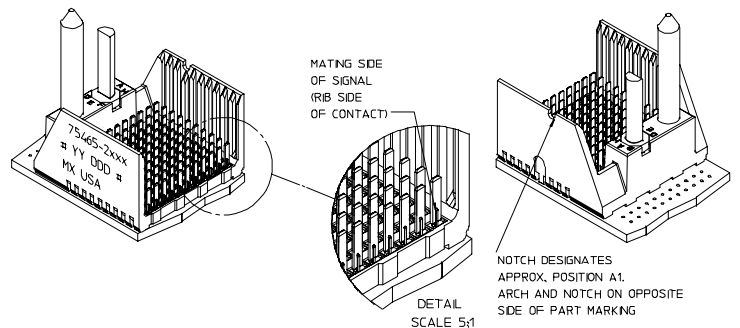

- NOTES:
- MATERIAL: HOUSING - LIQUID CRYSTAL POLYMER (LCP) GLASS-FILLED, UL 94V-0, COLOR - GRAY. SIGNAL CONTACT - HIGH PERFORMANCE COPPER ALLOY.
 - FINISHES: SELECTIVE GOLD (Au) ON CONTACT AREA. SELECTIVE TIN/LEAD (Sn/Pb) ON PCB TAILS. NICKEL (Ni) OVERALL.
 - THIS PART CONFORMS TO MOLEX PRODUCT SPECIFICATION PS-75221-999.
 - FOR MIXED CONTACT MATING LENGTHS CONSULT MOLEX FOR AVAILABILITY.
 - 10 COLUMN 4 PAIR L-SERIES SHOWN FOR ILLUSTRATION PURPOSES ONLY. FOR SPECIFIC PART NUMBER AND MATING INFORMATION PLEASE REFER TO CHART.
 - PACKAGE PER PK-70873-563.
 - MARK PART NUMBER AND DATE CODE APPROXIMATELY WHERE SHOWN.
 - OPTIONAL HOLE LOCATION FOR GROUNDED GUIDE PIN OR ADDITIONAL GUIDE PIN SUPPORT. FOR GROUNDED GUIDE PIN, HOLE TO BE PLATED, DRILL SIZE $\varnothing 2.58$, PAD SIZE $\varnothing 5.50$
 - THESE PARTS CONFORM TO MOLEX COSMETIC SPECIFICATION PS-45499-002 CLASS B.

REVISED EC NO: UCP 2007-2809 DRWN: JBRINGHAM 2007/05/07 CHKD: 2007/05/07 APPR: SREED 2007/05/08 DESCRIPTION	QUALITY SYMBOLS	GENERAL TOLERANCES (UNLESS SPECIFIED)	SCALE 5:1	DESIGN UNITS METRIC	THIRD ANGLE PROJECTION	REVISE ON CAD ONLY
	0.0 0.1	4 PLACES ±--- ±--- 3 PLACES ±--- ±--- 2 PLACES ±--- ±--- 1 PLACE ±--- ±--- ANGULAR ±---°	DIMENSION STYLE MM ONLY DRAWN BY NMARTIN DATE 2004/12/17 CHECKED BY SREED DATE 2004/12/17 APPROVED BY CBIXLER DATE 2004/12/17	TITLE	GBX 4-PAIR L-SERIES LEFT END BACKPLANE SALES ASSEMBLY DRAWING MOLEX INCORPORATED SEE CHART SD-75465-210	
	DRAFT WHERE APPLICABLE MUST REMAIN WITHIN DIMENSIONS	THIS DRAWING CONTAINS INFORMATION THAT IS PROPRIETARY TO MOLEX INCORPORATED AND SHOULD NOT BE USED WITHOUT WRITTEN PERMISSION	MATERIAL NO.	DOCUMENT NO.	SHEET NO.	
					1 OF 1	

19 18 17 16 15 14 13 12 11 10 9 8 7 6 5 4 3 2 1