

**PLEASE CHECK WWW.MOLEX.COM FOR LATEST PART INFORMATION**

**Part Number:** [0436500323](#)  
**Status:** **Active**  
**Overview:** [microfit\\_30](#)  
**Description:** 3.00mm (.118") Pitch Micro-Fit 3.0™ Header, Surface Mount Compatible, Single Row, Vertical, with Press-fit Metal Retention Clip, 3 Circuits, 0.76µm (30µ") Gold (Au) Selective Plating, Glow Wire Compatible

**Documents:**

[3D Model](#) [Product Specification PS-43650 \(PDF\)](#)  
[Drawing \(PDF\)](#) [RoHS Certificate of Compliance \(PDF\)](#)

**Agency Certification**

CSA	LR19980
TUV	R72081937
UL	E29179

**General**

Product Family	PCB Headers
Series	<a href="#">43650</a>
Application	Wire-to-Board
Comments	High Temperature Square Pin Solder Type
Overview	<a href="#">microfit_30</a>
Product Literature Order No	USA-106
Product Name	Micro-Fit 3.0™

**Physical**

Breakaway	No
Circuits (Loaded)	3
Circuits (maximum)	3
Color - Resin	Black
Durability (mating cycles max)	30
Flammability	94V-0
Glow-Wire Compliant	Yes
Mated Height (in)	0.680 In
Mated Height (mm)	17.27 mm
Material - Metal	Brass
Material - Plating Mating	Gold, Tin
Material - Plating Termination	Tin
Material - Resin	High Temperature Thermoplastic
Number of Rows	1
Orientation	Vertical
PCB Locator	Yes
PCB Retention	Yes
PCB Thickness Recommended (in)	0.062 In
PCB Thickness Recommended (mm)	1.60 mm
Packaging Type	Embossed Tape on Reel
Pitch - Mating Interface (in)	0.118 In
Pitch - Mating Interface (mm)	3.00 mm
Plating min: Mating (µin)	30, 35
Plating min: Mating (µm)	0.75, 0.88
Plating min: Termination (µin)	100, 35
Plating min: Termination (µm)	0.88, 2.5
Polarized to PCB	Yes
Shrouded	Fully
Stackable	No
Temperature Range - Operating	-40°C to +105°C

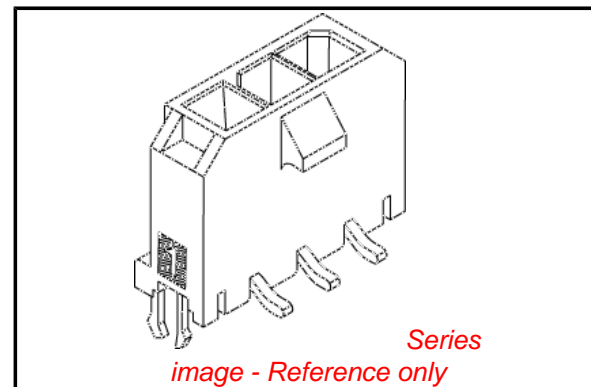

**EU RoHS**

**ELV and RoHS Compliant**  
**REACH SVHC Contains SVHC: No**  
**Halogen-Free Status**  
**Not Reviewed**

**China RoHS**



**Need more information on product environmental compliance?**

Email [productcompliance@molex.com](mailto:productcompliance@molex.com)  
 For a multiple part number RoHS Certificate of Compliance, [click here](#)

Please visit the [Contact Us](#) section for any non-product compliance questions.

**Search Parts in this Series**

[43650Series](#)

**Mates With**

[43645 Micro-Fit 3.0™ Receptacle Housing](#)

Termination Interface: Style Surface Mount

### **Electrical**

Current - Maximum per Contact 5A  
Voltage - Maximum 250V

### **Solder Process Data**

Duration at Max. Process Temperature (seconds) 30  
Lead-free Process Capability Reflow Capable (SMT only)  
Max. Cycles at Max. Process Temperature 3  
Process Temperature max. C 260

### **Material Info**

#### **Reference - Drawing Numbers**

Packaging Specification PK-70873-07\*\*  
Product Specification PS-43650  
Sales Drawing SD-43650-008  
Test Summary TS-43045-002

This document was generated on 05/24/2010

**PLEASE CHECK [WWW.MOLEX.COM](http://WWW.MOLEX.COM) FOR LATEST PART INFORMATION**

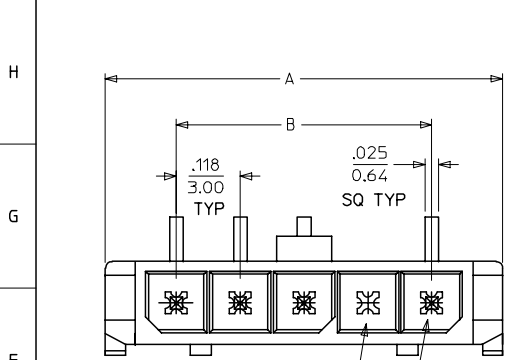
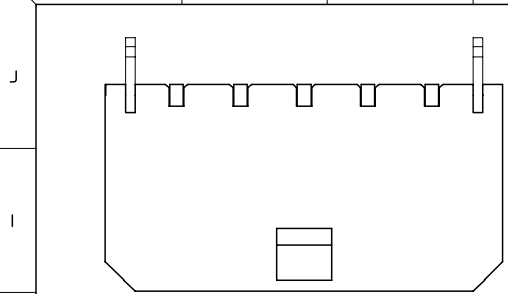

OPTIONAL VOIDED CKT SEE CHART FOR LOCATION

CIRCUIT 1

PCB LAYOUT: COMPONENT SIDE  
RECOMMENDED PCB THICKNESS: .062/157

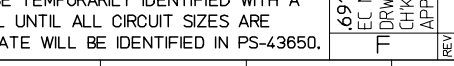
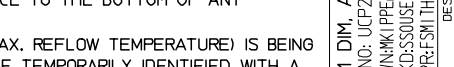
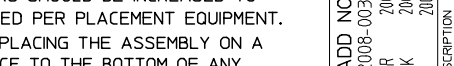
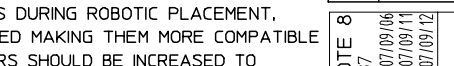
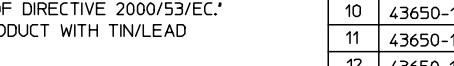
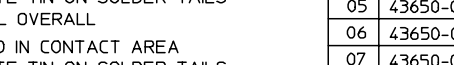
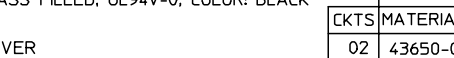
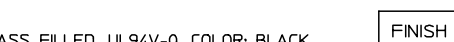
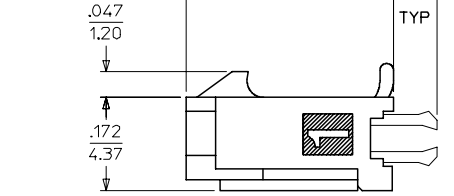
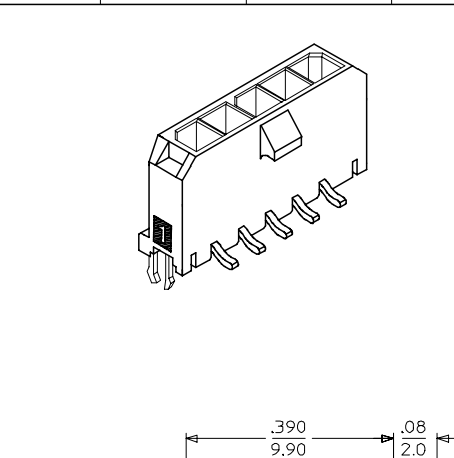
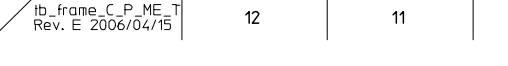
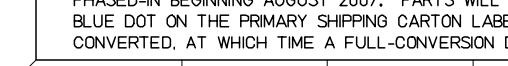
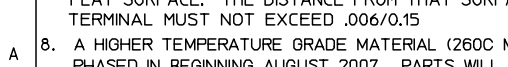
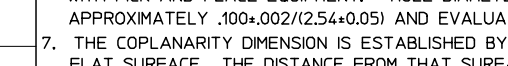
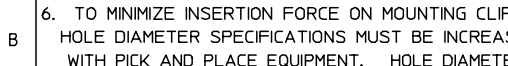
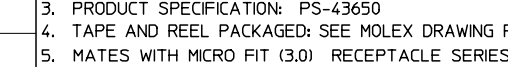
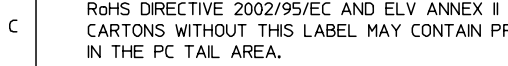
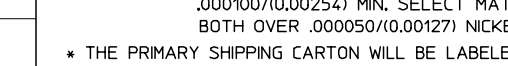
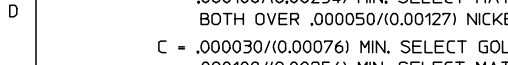
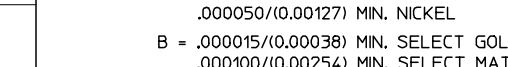
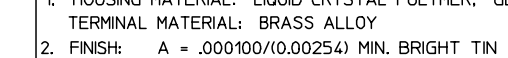

CKTS	DIM A	DIM B	DIM C
2	.380 9.65	.118 3.00	.287 7.30
3	.498 12.65	.236 6.00	.405 10.30
4	.616 15.65	.354 9.00	.524 13.30
5	.734 18.64	.472 12.00	.642 16.30
6	.852 21.64	.591 15.00	.760 19.30
7	.970 24.64	.709 18.00	.878 22.30
8	1.088 27.64	.827 21.00	.996 25.30
9	1.206 30.63	.945 24.00	1.114 28.30
10	1.325 33.66	1.063 27.00	1.232 31.30
11	1.443 36.65	1.181 30.00	1.350 34.30
12	1.561 39.65	1.299 33.00	1.469 37.30

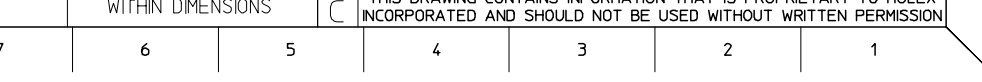
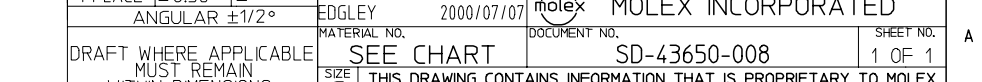
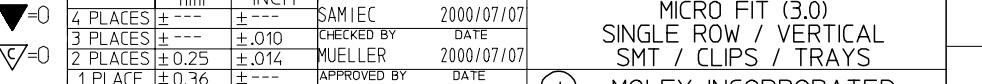
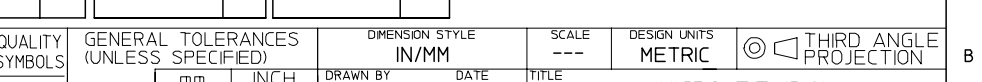
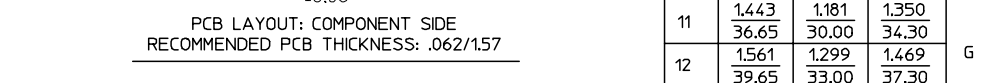

- NOTES:**
- HOUSING MATERIAL: LIQUID CRYSTAL POLYMER, GLASS FILLED, UL94V-0, COLOR: BLACK  
TERMINAL MATERIAL: BRASS ALLOY
  - FINISH: A = .000100/(0.00254) MIN. BRIGHT TIN OVER  
.000050/(0.00127) MIN. NICKEL  
B = .000015/(0.00038) MIN. SELECT GOLD IN CONTACT AREA  
.000100/(0.00254) MIN. SELECT MATTE TIN ON SOLDER TAILS  
BOTH OVER .000050/(0.00127) NICKEL OVERALL  
C = .000030/(0.00076) MIN. SELECT GOLD IN CONTACT AREA  
.000100/(0.00254) MIN. SELECT MATTE TIN ON SOLDER TAILS  
BOTH OVER .000050/(0.00127) NICKEL OVERALL
  - \* THE PRIMARY SHIPPING CARTON WILL BE LABELED 'COMPLIANT TO  
RoHS DIRECTIVE 2002/95/EC AND ELV ANNEX II OF DIRECTIVE 2000/53/EC.'  
CARTONS WITHOUT THIS LABEL MAY CONTAIN PRODUCT WITH TIN/LEAD  
IN THE PC TAIL AREA.
  - PRODUCT SPECIFICATION: PS-43650
  - TAPE AND REEL PACKAGED: SEE MOLEX DRAWING PK-70873-07\*\*
  - MATES WITH MICRO FIT (3.0) RECEPTACLE SERIES 43645
  - TO MINIMIZE INSERTION FORCE ON MOUNTING CLIPS DURING ROBOTIC PLACEMENT,  
HOLE DIAMETER SPECIFICATIONS MUST BE INCREASED MAKING THEM MORE COMPATIBLE  
WITH PICK AND PLACE EQUIPMENT. HOLE DIAMETERS SHOULD BE INCREASED TO  
APPROXIMATELY .100±.002/(2.54±.05) AND EVALUATED PER PLACEMENT EQUIPMENT.
  - THE COPLANARITY DIMENSION IS ESTABLISHED BY PLACING THE ASSEMBLY ON A  
FLAT SURFACE. THE DISTANCE FROM THAT SURFACE TO THE BOTTOM OF ANY  
TERMINAL MUST NOT EXCEED .006/0.15
  - A HIGHER TEMPERATURE GRADE MATERIAL (260C MAX. REFLOW TEMPERATURE) IS BEING  
PHASED-IN BEGINNING AUGUST 2007. PARTS WILL BE TEMPORARILY IDENTIFIED WITH A  
BLUE DOT ON THE PRIMARY SHIPPING CARTON LABEL UNTIL ALL CIRCUIT SIZES ARE  
CONVERTED. AT WHICH TIME A FULL-CONVERSION DATE WILL BE IDENTIFIED IN PS-43650.

CKTS	FINISH A		FINISH B		FINISH C	
	MATERIAL NO:	VOID CKT	MATERIAL NO:	VOID CKT	MATERIAL NO:	VOID CKT
02	43650-0221		43650-0222		43650-0223	
03	43650-0321		43650-0322		43650-0323	
04	43650-0421		43650-0422		43650-0423	
05	43650-0521		43650-0522		43650-0523	
06	43650-0621		43650-0622		43650-0623	
07	43650-0721		43650-0722		43650-0723	
08	43650-0821		43650-0822		43650-0823	
09	43650-0921		43650-0922		43650-0923	
10	43650-1021		43650-1022		43650-1023	
11	43650-1121		43650-1122		43650-1123	
12	43650-1221		43650-1222		43650-1223	
03	43650-0332	02				

<b>691 DIM. ADD NOTE 8</b> EC NO: UCP2008-0037 DRAWN BY: IPPER 2007/09/06 CHKD: SSOUSEK 2007/09/11 APPR: FSM TH 2007/09/12	QUALITY SYMBOLS ▽=0 ▽=0	GENERAL TOLERANCES (UNLESS SPECIFIED) mm INCH 4 PLACES ± --- ± --- 3 PLACES ± --- ± .010 2 PLACES ± 0.25 ± .014 1 PLACE ± 0.36 ± --- ANGULAR ±1/2°	DIMENSION STYLE IN/MM DRAWN BY: SAMIEC DATE: 2000/07/07 CHECKED BY: MUELLER DATE: 2000/07/07 APPROVED BY: EDGLEY DATE: 2000/07/07	SCALE: --- DESIGN UNITS: METRIC THIRD ANGLE PROJECTION	MICRO FIT (3.0) SINGLE ROW / VERTICAL SMT / CLIPS / TRAYS MOLEX INCORPORATED	MATERIAL NO. DOCUMENT NO. SD-43650-008 SHEET NO. 1 OF 1

