

PLEASE CHECK WWW.MOLEX.COM FOR LATEST PART INFORMATION

Part Number: [0436500316](#)
Status: **Active**
Overview: [microfit_30](#)
Description: 3.00mm (.118") Pitch Micro-Fit 3.0™ Header, Surface Mount Compatible, Single Row, Vertical, with PCB Polarizing Peg, 3 Circuits, 0.38µm (15µ") Gold (Au) Selective Plating, Glow Wire Compatible

Documents:

3D Model	Product Specification PS-43650 (PDF)
Drawing (PDF)	RoHS Certificate of Compliance (PDF)
Packaging Specification (PDF)	

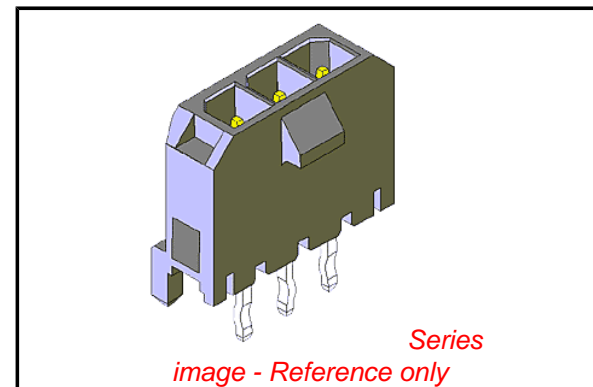

Agency Certification

CSA	LR19980
TUV	R72081037
UL	E29179

General

Product Family	PCB Headers
Series	43650
Application	Wire-to-Board
Comments	High Temperature Square Pin Offset Through Hole Mounting Solder Type
Overview	microfit_30
Product Literature Order No	USA-106
Product Name	Micro-Fit 3.0™

Physical

Breakaway	No
Circuits (Loaded)	3
Circuits (maximum)	3
Color - Resin	Black
Durability (mating cycles max)	30
Flammability	94V-0
Glow-Wire Compliant	Yes
Mated Height (in)	0.680 In
Mated Height (mm)	17.27 mm
Material - Metal	Brass
Material - Plating Mating	Gold
Material - Plating Termination	Tin
Material - Resin	High Temperature Thermoplastic
Number of Rows	1
Orientation	Vertical
PCB Locator	Yes
PCB Retention	Yes
PCB Thickness Recommended (in)	0.062 In
PCB Thickness Recommended (mm)	1.60 mm
Packaging Type	Tray
Pitch - Mating Interface (in)	0.118 In
Pitch - Mating Interface (mm)	3.00 mm
Plating min: Mating (µin)	15.2
Plating min: Mating (µm)	0.38
Plating min: Termination (µin)	100
Plating min: Termination (µm)	2.5
Polarized to PCB	Yes
Shrouded	Fully

EU RoHS

ELV and RoHS Compliant
REACH SVHC Contains SVHC: No
Halogen-Free Status

China RoHS



Halogen-Free

Need more information on product environmental compliance?

Email productcompliance@molex.com
 For a multiple part number RoHS Certificate of Compliance, [click here](#)

Please visit the [Contact Us](#) section for any non-product compliance questions.

Search Parts in this Series

[43650Series](#)

Mates With

[43645 Micro-Fit 3.0™ Receptacle Housing](#)

Stackable	No
Surface Mount Compatible (SMC)	Yes
Temperature Range - Operating	-40°C to +105°C
Termination Interface: Style	Through Hole - Kinked Pin

Electrical

Current - Maximum per Contact	5A
Voltage - Maximum	250V

Solder Process Data

Duration at Max. Process Temperature (seconds)	30
Lead-free Process Capability	SMC & Wave Capable (TH only)
Max. Cycles at Max. Process Temperature	3
Process Temperature max. C	260

Material Info

Reference - Drawing Numbers

Packaging Specification	PK-70873-0811
Product Specification	PS-43650
Sales Drawing	SD-43650-006
Test Summary	TS-43045-002

This document was generated on 05/24/2010

PLEASE CHECK WWW.MOLEX.COM FOR LATEST PART INFORMATION

13 12 11 10 9 8 7 6 5 4 3 2 1

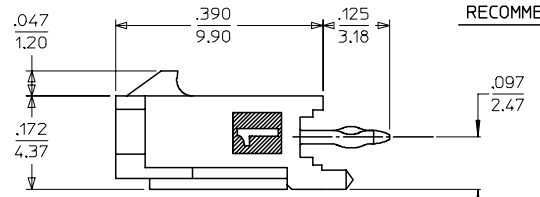
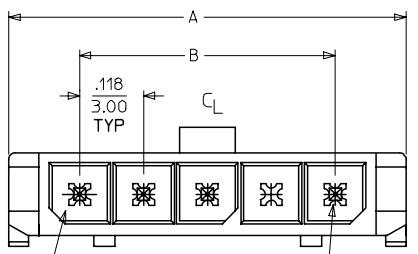
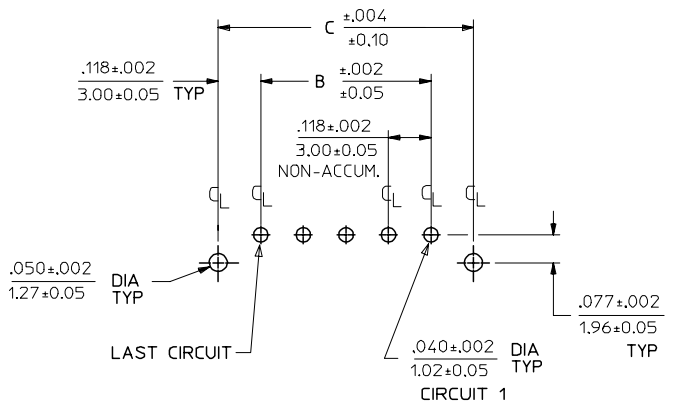
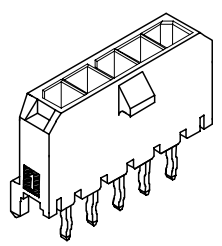
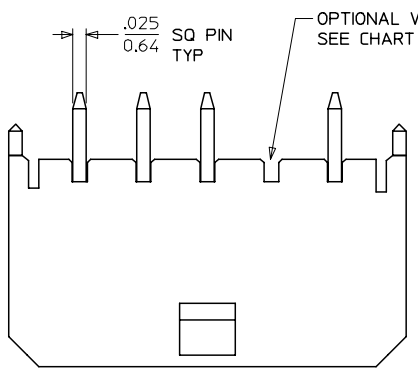

PCB LAYOUT: COMPONENT SIDE
RECOMMENDED PCB THICKNESS: .062/1.57

CKTS	A	B	C
2	.380 9.65	.118 3.00	.354 9.00
3	.498 12.65	.236 6.00	.472 12.00
4	.616 15.65	.354 9.00	.591 15.00
5	.734 18.64	.472 12.00	.709 18.00
6	.852 21.64	.591 15.00	.827 21.00
7	.970 24.64	.709 18.00	.945 24.00
8	1.088 27.64	.827 21.00	1.063 27.00
9	1.206 30.63	.945 24.00	1.181 30.00
10	1.325 33.66	1.063 27.00	1.299 33.00
11	1.443 36.65	1.181 30.00	1.417 36.00
12	1.561 39.65	1.299 33.00	1.535 39.00

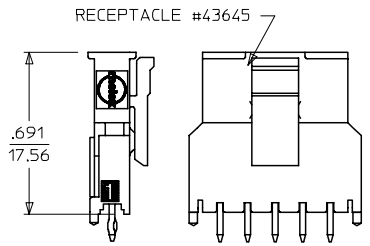
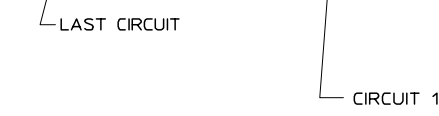

FINISH A			FINISH B			FINISH C		
CKTS	MATERIAL NO:	VOID CKT	CKTS	MATERIAL NO:	VOID CKT	CKTS	MATERIAL NO:	VOID CKT
02	43650-0215		02	43650-0216		02	43650-0217	
03	43650-0315		03	43650-0316		03	43650-0317	
04	43650-0415		04	43650-0416		04	43650-0417	
05	43650-0515		05	43650-0516		05	43650-0517	
06	43650-0615		06	43650-0616		06	43650-0617	
07	43650-0715		07	43650-0716		07	43650-0717	
08	43650-0815		08	43650-0816		08	43650-0817	
09	43650-0915		09	43650-0916		09	43650-0917	
10	43650-1015		10	43650-1016		10	43650-1017	
11	43650-1115		11	43650-1116		11	43650-1117	
12	43650-1215		12	43650-1216		12	43650-1217	
03	43650-0330	02	04	43650-0431	02,03	04	43650-0430	02,03
05	43650-9915	03						
05	43650-0530	02,04						
06	43650-0630	02,04,05						

- NOTES:
- HOUSING MATERIAL: LIQUID CRYSTAL POLYMER, GLASS FILLED, UL94V-0, COLOR: BLACK
TERMINAL MATERIAL: BRASS ALLOY
 - FINISH:
A = .000100/(0.00254) MIN. BRIGHT TIN OVER .000050/(0.00127) MIN. NICKEL
B = .000015/(0.00038) MIN. SELECT GOLD IN CONTACT AREA .000100/(0.00254) MIN. SELECT MATTE TIN ON SOLDER TAILS BOTH OVER .000050/(0.00127) NICKEL OVERALL
C = .000030/(0.00076) MIN. SELECT GOLD IN CONTACT AREA .000100/(0.00254) MIN. SELECT MATTE TIN ON SOLDER TAILS BOTH OVER .000050/(0.00127) NICKEL OVERALL
 - * THE PRIMARY SHIPPING CARTON WILL BE LABELED "COMPLIANT TO RoHS DIRECTIVE 2002/95/EC AND ELV ANNEX II OF DIRECTIVE 2000/53/EC." CARTONS WITHOUT THIS LABEL MAY CONTAIN PRODUCT WITH TIN/LEAD IN THE PC TAIL AREA.
 - PRODUCT SPECIFICATION: PS-43650
 - TRAY PACKAGED : SEE MOLEX DRAWING PK-70873-0811
 - MATES WITH MICRO FIT (3.0) RECEPTACLE SERIES 43645
 - A HIGHER TEMPERATURE GRADE MATERIAL (260C MAX. REFLOW TEMPERATURE) IS BEING PHASED-IN BEGINNING AUGUST 2007. PARTS WILL BE TEMPORARILY IDENTIFIED WITH A BLUE DOT ON THE PRIMARY SHIPPING CARTON LABEL UNTIL ALL CIRCUIT SIZES ARE CONVERTED, AT WHICH TIME A FULL-CONVERSION DATE WILL BE IDENTIFIED IN PS-43650.

691 DIM. ADD NOTE 6 EC NO: UCP2008-0037 DRAWN: KIPER 2007/09/06 CHKD: SSOUSEK 2007/09/11 APPR: FSM TH 2007/09/12	QUALITY SYMBOLS ▽=0 ▽=0	GENERAL TOLERANCES (UNLESS SPECIFIED) mm INCH 4 PLACES ± --- ± --- 3 PLACES ± --- ± .010 2 PLACES ± 0.25 ± .014 1 PLACE ± 0.36 ± --- ANGULAR ±1/2°	DIMENSION STYLE IN/MM DRAWN BY SAMIEC DATE 2000/07/07 CHECKED BY MUELLER DATE 2000/07/07 APPROVED BY EDGLEY DATE 2000/07/07	SCALE --- DESIGN UNITS METRIC THIRD ANGLE PROJECTION
		DRAFT WHERE APPLICABLE MUST REMAIN WITHIN DIMENSIONS	MATERIAL NO. SEE CHART THIS DRAWING CONTAINS INFORMATION THAT IS PROPRIETARY TO MOLEX INCORPORATED AND SHOULD NOT BE USED WITHOUT WRITTEN PERMISSION	MOLEX MOLEX INCORPORATED DOCUMENT NO. SD-43650-006 SHEET NO. 1 OF 1

12 11 10 9 8 7 6 5 4 3 2 1