

N AND P-Channel Enhancement Mode POWER MOSFET

(P/b) Lead(Pb)-Free

Features:

- * Low Gate charge
- * Low On-Resistance
 N-CH $R_{DS(ON)} < 42m\Omega @ V_{GS} = 4.5V$
 P-CH $R_{DS(ON)} < 90m\Omega @ V_{GS} = -4.5V$
- * SOP-8 Package

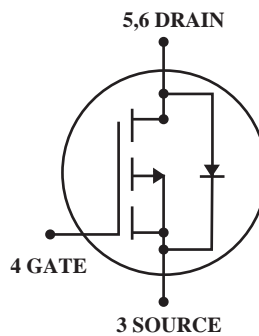
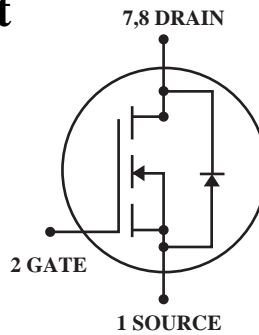

N-CHANNEL
DRAIN SOURCE VOLTAGE
30 VOLTAGE
DRAIN CURRENT
7 AMPERES

P-CHANNEL
DRAIN SOURCE VOLTAGE
-30 VOLTAGE
DRAIN CURRENT
-5.3 AMPERES

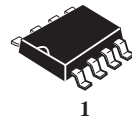

SOP-8

Maximum Ratings ($T_A=25^\circ C$ Unless Otherwise Specified)

Rating	Symbol	Value		Unit	
		N-Channl	P-Channl		
Drain-Source Voltage	V_{DS}	30	-30	V	
Gate-Source Voltage	V_{GS}	± 20	± 16	V	
Continuous Drain Current ³	I_D	$T_A=25^\circ C$	7	-5.3	A
		$T_A=75^\circ C$	5.8	-4.7	
Pulsed Drain Current ¹	I_{DM}	20	-20	A	
Total Power Dissipation	P_D	$T_A=25^\circ C$ 2.0		W	
Maximum Junction-ambient ³	$R_{\theta JA}$	62.5		$^\circ C/W$	
Operating Junction Temperature Range	T_J	+150		$^\circ C$	
Storage Temperature Range	T_{stg}	-55~+150		$^\circ C$	

Device Marking

WTK4501=4501SS

N-Channel Electrical Characteristics (T_A = 25°C Unless otherwise noted)

Characteristic	Symbol	Min	Typ	Max	Unit
----------------	--------	-----	-----	-----	------

OFF Characteristics

Drain-Source Breakdown Voltage V _{GS} =0, I _D =250μA	BV _{DSS}	30	-	-	V
Drain-Source Leakage Current T _j =25°C, V _{DS} =30V, V _{GS} =0V T _j =70°C, V _{DS} =24V, V _{GS} =0V	I _{DSS}	-	-	1 25	μA
Gate-Source Leakage current V _{GS} =±20V	I _{GSS}	-	-	±100	nA

ON Characteristics

Gate-Source Threshold Voltage V _{DS} =V _{GS} , I _D =250μA	V _{GS(Th)}	1.0	-	3.0	V
Drain-Source On-Resistance V _{GS} =10V, I _D =7A V _{GS} =4.5V, I _D =5A	R _{DS(on)}	-	-	28 42	mΩ
Forward Transconductance V _{DS} =10V, I _D =7A	g _{fs}	-	13	-	S

Dynamic Characteristics

Input Capacitance V _{GS} =0V, V _{DS} =20V, f=1.0MHz	C _{iss}	-	645	-	pF
Output Capacitance V _{GS} =0V, V _{DS} =20V, f=1.0MHz	C _{oss}	-	150	-	
Reverse Transfer Capacitance V _{GS} =0V, V _{DS} =20V, f=1.0MHz	C _{rss}	-	95	-	

Switching Characteristics

Turn-on Delay Time ² V _{DS} =15V, V _{GS} =10V, I _D =1A, R _G =3.3Ω, R _D =15Ω	t _{d(on)}	-	6	-	ns
Rise Time V _{DS} =15V, V _{GS} =10V, I _D =1A, R _G =3.3Ω, R _D =15Ω	t _r	-	5.2	-	
Turn-off Delay Time V _{DS} =15V, V _{GS} =10V, I _D =1A, R _G =3.3Ω, R _D =15Ω	t _{d(off)}	-	18.8	-	
Fall Time V _{DS} =15V, V _{GS} =10V, I _D =1A, R _G =3.3Ω, R _D =15Ω	t _f	-	4.4	-	
Total Gate Charge ² V _{DS} =24V, V _{GS} =4.5V, I _D =7A	Q _g	-	8.4	-	nC
Gate-Source Charge V _{DS} =24V, V _{GS} =4.5V, I _D =7A	Q _{gs}	-	2.1	-	
Gate-Source Change V _{DS} =24V, V _{GS} =4.5V, I _D =7A	Q _{gd}	-	4.7	-	

Source-Drain Diode Characteristics

Forward On Voltage ² I _S =7A, V _{GS} =0V	V _{SD}	-	-	1.2	V
Continuous Source Current(Body diode) V _D =V _G =0V, V _S =1.2V	I _S	-	-	1.67	A

Note: 1. Pulse width limited by Max. junction temperature.

2. Pulse width ≤ 300us, duty cycle ≤ 2%.

3. Surface mounted on 1 in² copper pad of FR4 board, 135°C/W when mounted on Min. copper pad.

P-Channel Electrical Characteristics (T_A = 25°C Unless otherwise noted)

Characteristic	Symbol	Min	Typ	Max	Unit
----------------	--------	-----	-----	-----	------

OFF Characteristics

Drain-Source Breakdown Voltage V _{GS} =0, I _D =-250μA	BV _{DSS}	-30	-	-	V
Drain-Source Leakage Current T _j =25°C, V _{DS} =-30V, V _{GS} =0V T _j =70°C, V _{DS} =-24V, V _{GS} =0V	I _{DSS}	-	-	-1 -25	μA
Gate-Source Leakage current V _{GS} =±16V	I _{GSS}	-	-	±100	nA

ON Characteristics

Gate-Source Threshold Voltage V _{DS} =V _{GS} , I _D =-250μA	V _{GS(Th)}	-1.0	-	-3.0	V
Drain-Source On-Resistance ² V _{GS} =-10V, I _D =-5.3A V _{GS} =-4.5V, I _D =-4.2A	R _{DS(on)}	-	-	50 90	mΩ
Forward Transconductance V _{DS} =-10V, I _D =-5.3A	g _{fs}	-	8.5	-	S

Dynamic Characteristics

Input Capacitance V _{GS} =0V, V _{DS} =-15V, f=1.0MHz	C _{iss}	-	790	-	pF
Output Capacitance V _{GS} =0V, V _{DS} =-15V, f=1.0MHz	C _{oss}	-	440	-	
Reverse Transfer Capacitance V _{GS} =0V, V _{DS} =-15V, f=1.0MHz	C _{rss}	-	120	-	

Switching Characteristics

Turn-on Delay Time ² V _{DS} =-15V, V _{GS} =-10V, I _D =-1A, R _G =6Ω, R _D =15Ω	t _{d(on)}	-	12	-	ns
Rise Time V _{DS} =-15V, V _{GS} =-10V, I _D =-1A, R _G =6Ω, R _D =15Ω	t _r	-	20	-	
Turn-off Delay Time V _{DS} =-15V, V _{GS} =-10V, I _D =-1A, R _G =6Ω, R _D =15Ω	t _{d(off)}	-	45	-	
Fall Time V _{DS} =-15V, V _{GS} =-10V, I _D =-1A, R _G =6Ω, R _D =15Ω	t _f	-	27	-	
Total Gate Charge ² V _{DS} =-15V, V _{GS} =-10V, I _D =-5.3A	Q _g	-	20	-	nC
Gate-Source Charge V _{DS} =-15V, V _{GS} =-10V, I _D =-5.3A	Q _{gs}	-	3.5	-	
Gate-Source Change V _{DS} =-15V, V _{GS} =-10V, I _D =-5.3A	Q _{gd}	-	2	-	

Source-Drain Diode Characteristics

Forward On Voltage ² I _S =-2.6A, V _{GS} =0V	V _{SD}	-	-	-1.2	V
Continuous Source Current(Body Diode) V _D =V _G =0V, V _S =-1.2V	I _S	-	-	-1.67	A

Note: 1. Pulse width limited by Max. junction temperature.

2. Pulse width ≤ 300us, duty cycle ≤ 2%.

3. Surface mounted on 1 in² copper pad of FR4 board, 135°C/W when mounted on Min. copper pad.

Characteristics Curve N-Channel

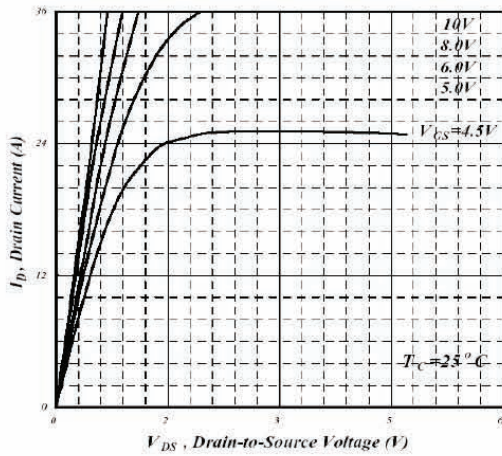

Fig 1. Typical Output Characteristics

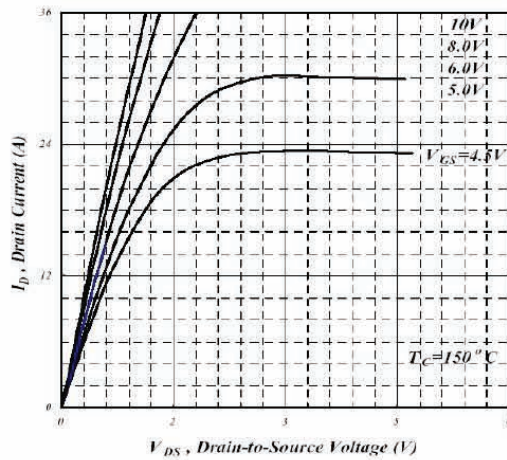

Fig 2. Typical Output Characteristics

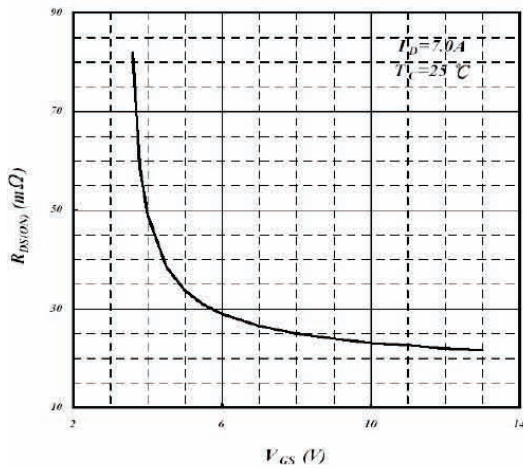

Fig 3. On-Resistance v.s. Gate Voltage

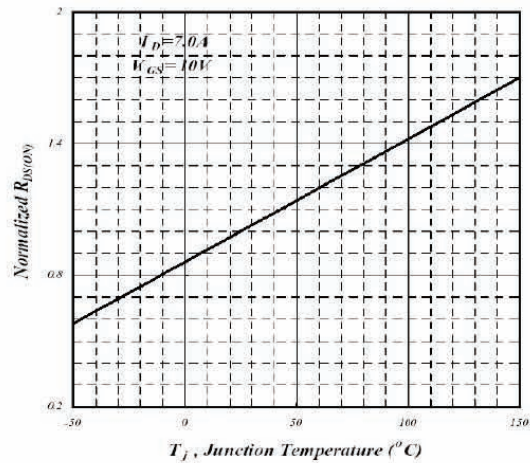

Fig 4. Normalized On-Resistance v.s. Junction Temperature

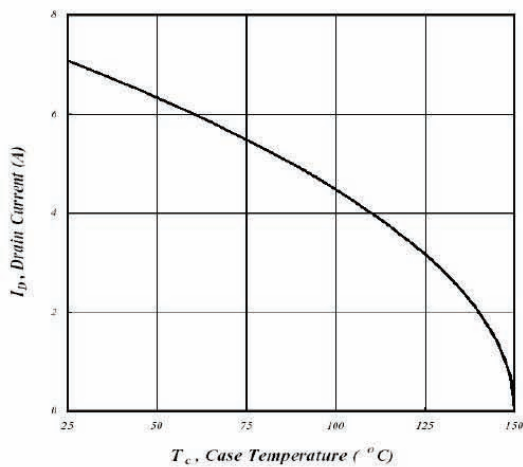

Fig 5. Maximum Drain Current v.s. Case Temperature

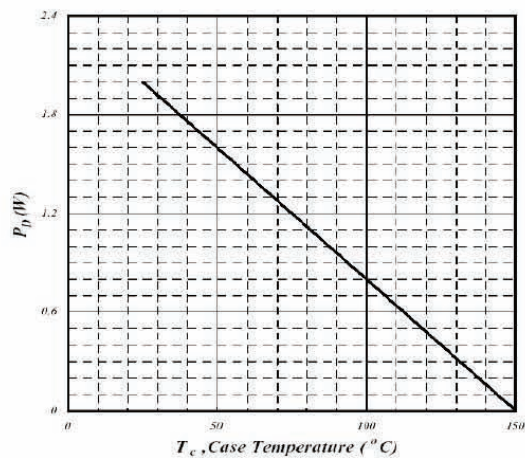

Fig 6. Type Power Dissipation

N-Channel

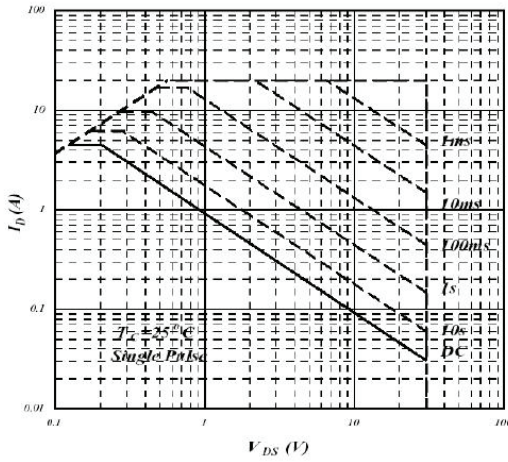

Fig 7. Maximum Safe Operating Area

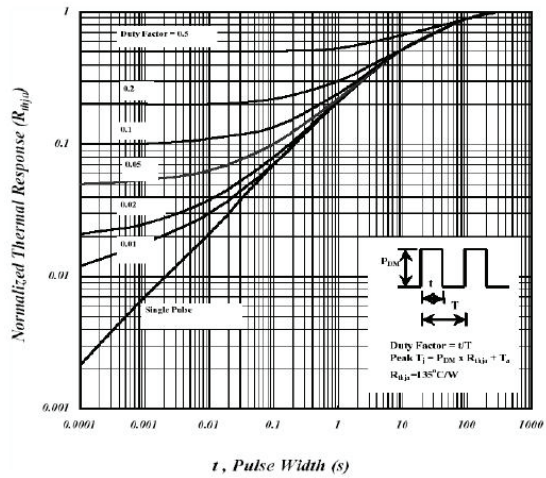

Fig 8. Effective Transient Thermal Impedance

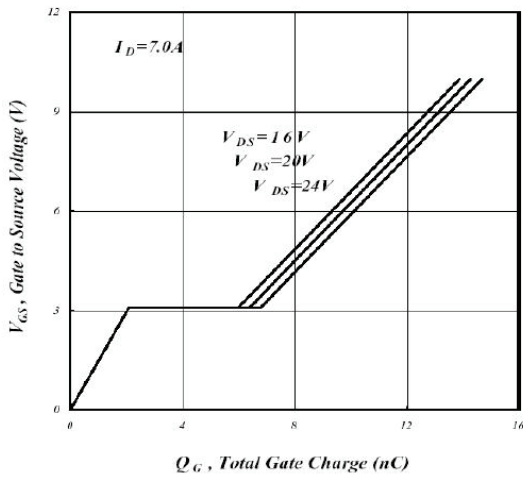

Fig 9. Gate Charge Characteristics

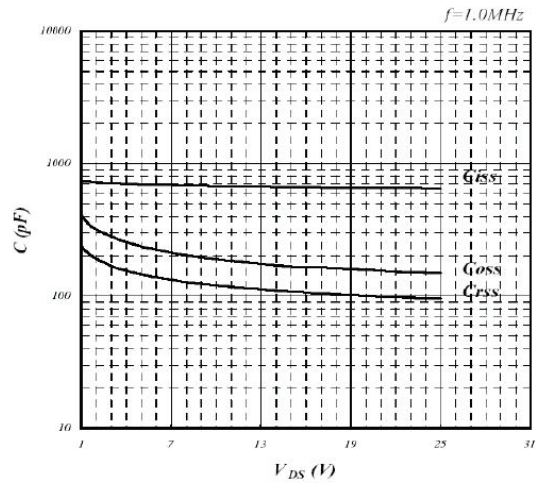

Fig 10. Typical Capacitance Characteristics

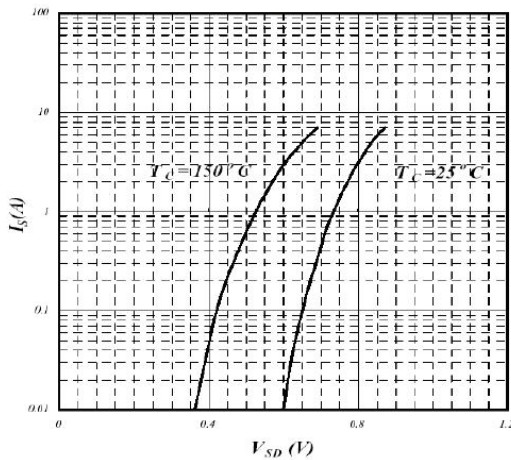

Fig 11. Forward Characteristics of Reverse Diode

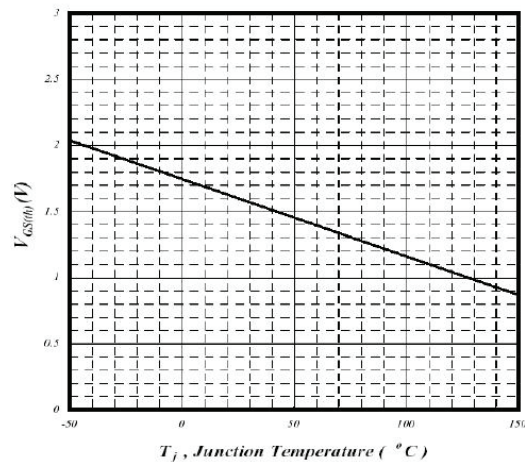

Fig 12. Gate Threshold Voltage v.s. Junction Temperature

N-Channel

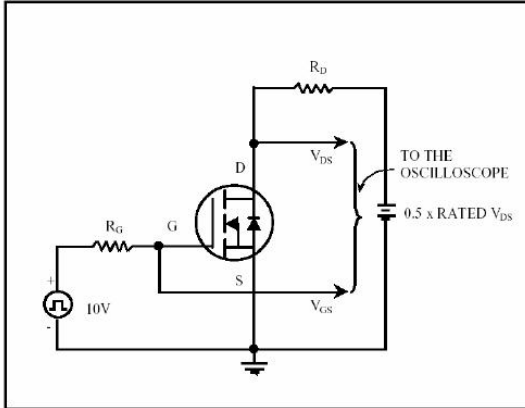

Fig 13. Switching Time Circuit

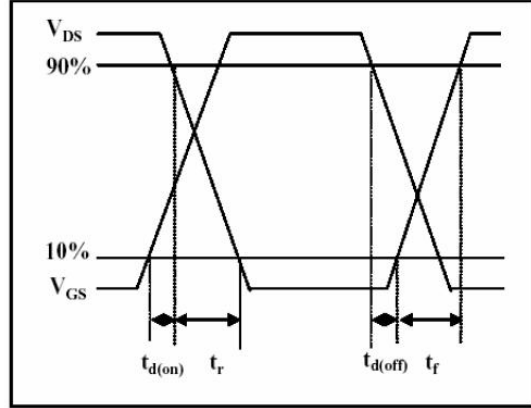

Fig 14. Switching Time Waveform

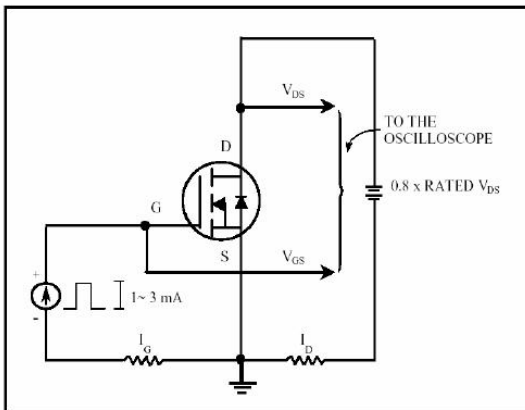

Fig 15. Gate Charge Circuit

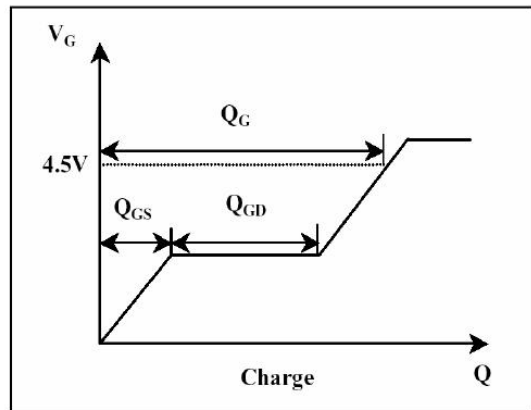

Fig 16. Gate Charge Waveform

Characteristics Curve P-Channel

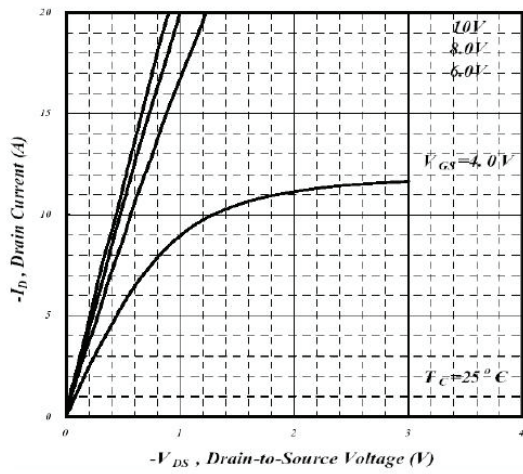

Fig 1. Typical Output Characteristics

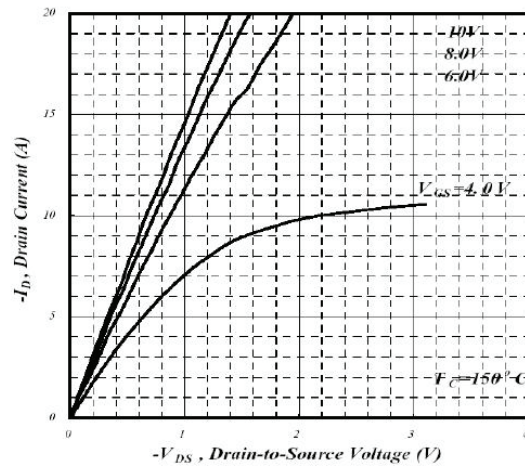

Fig 2. Typical Output Characteristics

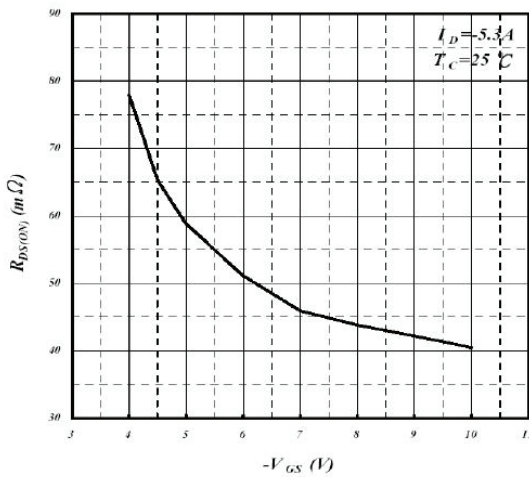

Fig 3. On-Resistance v.s. Gate Voltage

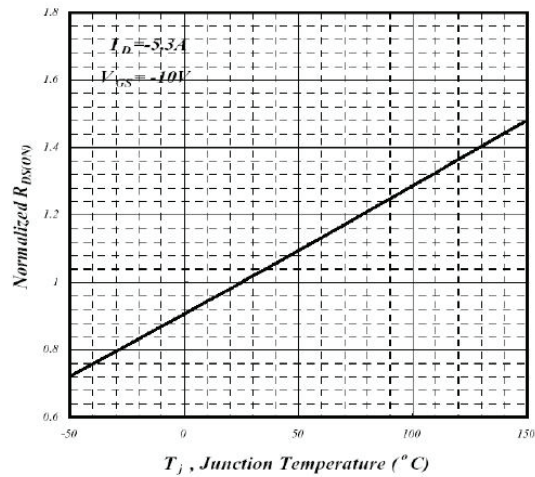

Fig 4. Normalized On-Resistance v.s. Junction Temperature

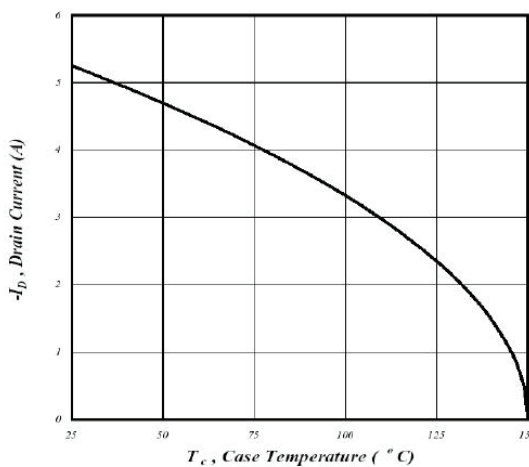

Fig 5. Maximum Drain Current v.s. Case Temperature

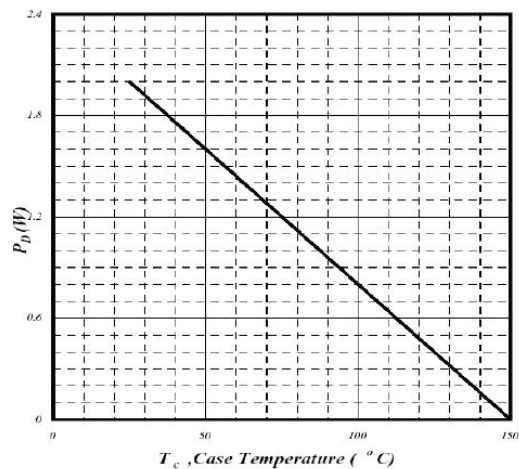

Fig 6. Type Power Dissipation

P-Channel

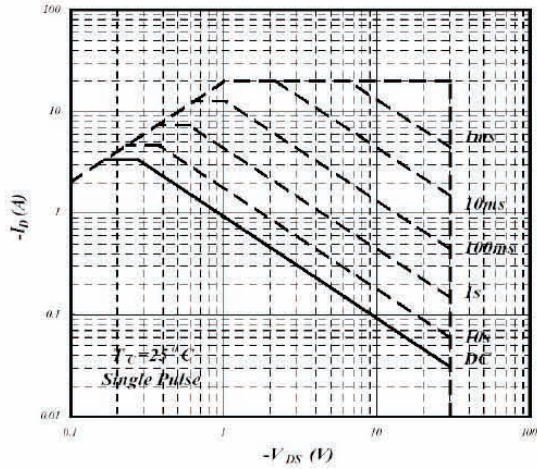

Fig 7. Maximum Safe Operating Area

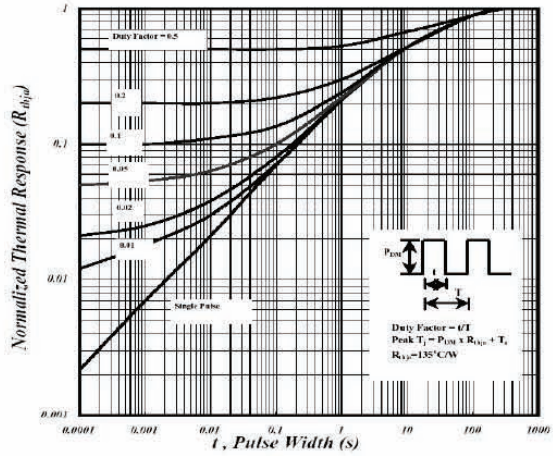

Fig 8. Effective Transient Thermal Impedance

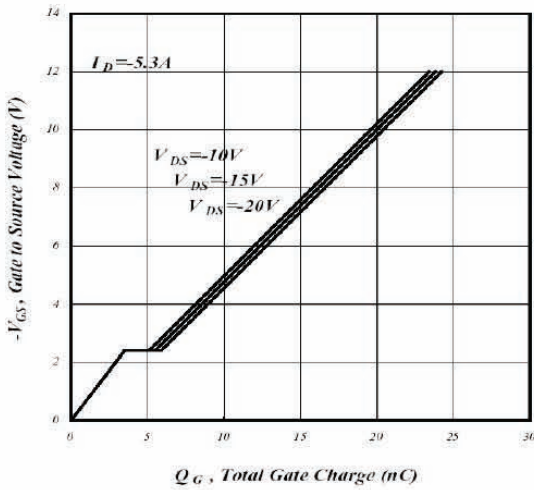

Fig 9. Gate Charge Characteristics

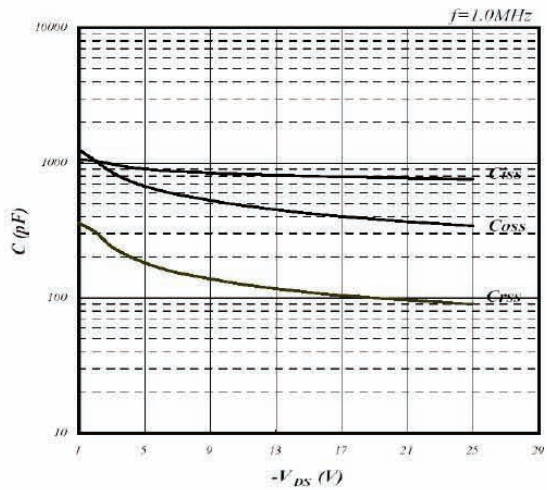

Fig 10. Typical Capacitance Characteristics

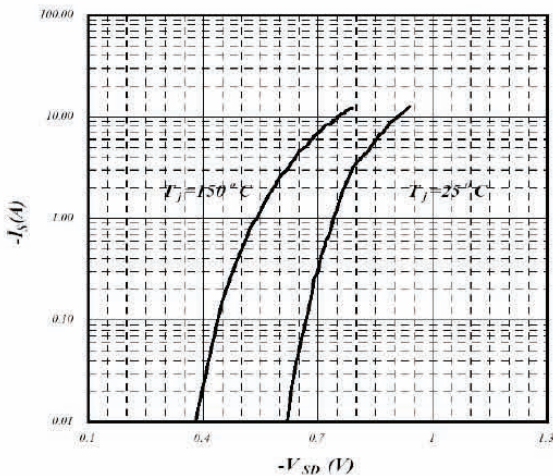

Fig 11. Forward Characteristics of Reverse Diode

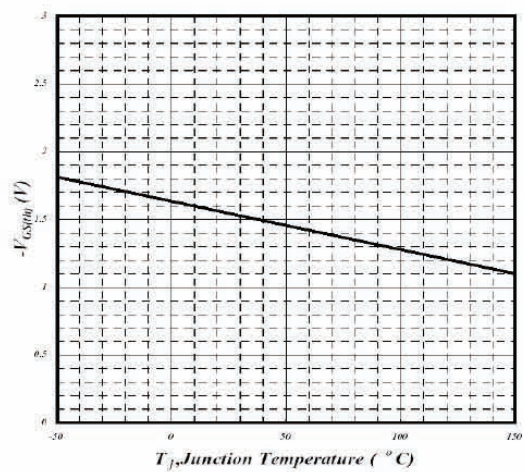

Fig 12. Gate Threshold Voltage v.s. Junction Temperature

P-Channel

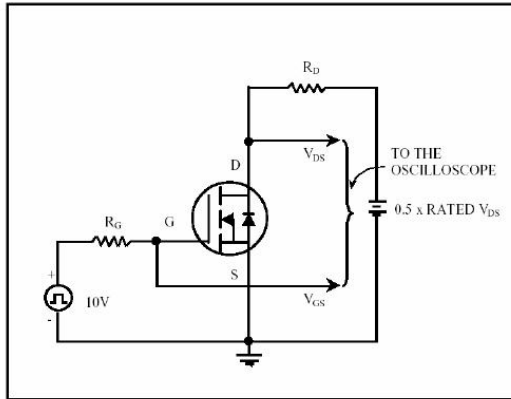

Fig 13. Switching Time Circuit

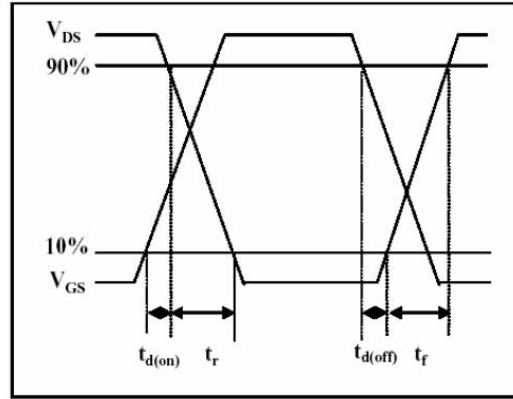

Fig 14. Switching Time Waveform

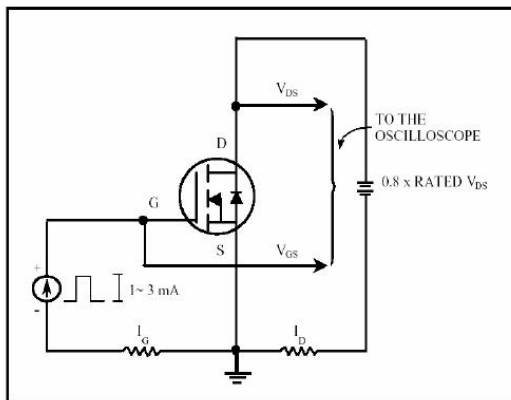

Fig 15. Gate Charge Circuit

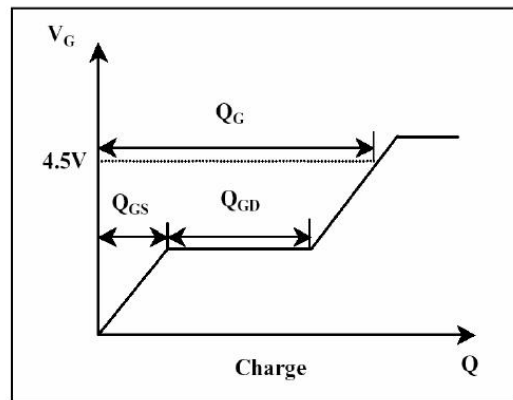
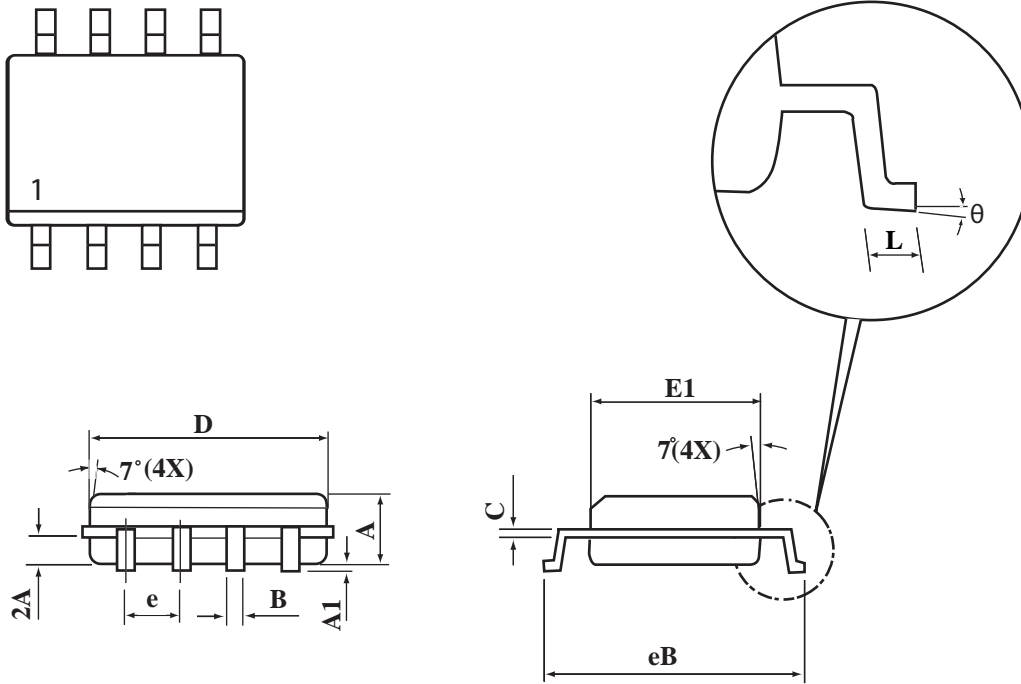

Fig 16. Gate Charge Waveform

SOP-8 Package Outline Dimensions

Unit:mm



SYMBOLS	MILLIMETERS	
	MIN	MAX
A	1.35	1.75
A1	0.10	0.20
B	0.35	0.45
C	0.18	0.23
D	4.69	4.98
E1	3.56	4.06
eB	5.70	6.30
e	1.27 BSC	
L	0.60	0.80
θ	0°	8°