

Reverse conducting IGBT with monolithic body diode

Features:

- Powerful monolithic body diode with low forward voltage designed for soft commutation only
- TrenchStop® technology offering:
 - very tight parameter distribution
 - high ruggedness, temperature stable behavior
 - low V_{CEsat}
 - easy parallel switching capability due to positive temperature coefficient in V_{CEsat}
- Low EMI
- New TO-247HC package offers increased air & creepage distances compared to TO247 package
- Qualified according to JEDEC J-STD-020 and JESD-022 for target applications
- Pb-free lead plating; RoHS compliant
- Halogen free (according to IEC 61249-2-21)
- Complete product spectrum and PSpice Models: <http://www.infineon.com/igbt/>

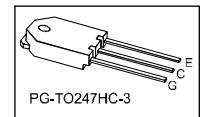
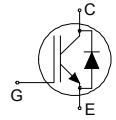

Applications:

- Inductive cooking

| Type | V_{CE} | I_C | $V_{CEsat}, T_{vj}=25^{\circ}C$ | T_{vjmax} | Marking | Package |
|-------------|----------|-------|---------------------------------|-------------|----------|--------------|
| IHY15N120R3 | 1200V | 15A | 1.48V | 175°C | H15R1203 | PG-TO247HC-3 |

Maximum ratings

| Parameter | Symbol | Value | Unit |
|--|-------------|----------------------|------|
| Collector-emitter voltage | V_{CE} | 1200 | V |
| DC collector current, limited by T_{vjmax} $T_C = 25^{\circ}C$ $T_C = 100^{\circ}C$ | I_C | 30.0 15.0 | A |
| Pulsed collector current, t_p limited by T_{vjmax} | I_{Cpuls} | 45.0 | A |
| Turn off safe operating area $V_{CE} \leq 1200V, T_{vj} \leq 175^{\circ}C$ | - | 45.0 | A |
| Diode forward current, limited by T_{vjmax} $T_C = 25^{\circ}C$ $T_C = 100^{\circ}C$ | I_F | 30.0 15.0 | A |
| Diode pulsed current, t_p limited by T_{vjmax} | I_{Fpuls} | 45.0 | A |
| Gate-emitter voltage Transient Gate-emitter voltage ($t_p = 10\mu s, D < 0.010$) | V_{GE} | ± 20 ± 25 | V |
| Power dissipation $T_C = 25^{\circ}C$ Power dissipation $T_C = 100^{\circ}C$ | P_{tot} | 254.0 127.0 | W |
| Operating junction temperature | T_{vj} | -40...+175 | °C |
| Storage temperature | T_{stg} | -55...+175 | °C |
| Soldering temperature, for 10 s (according to JEDEC J-STA-020A) | | 260 | °C |
| Mounting torque, M3 screw Maximum of mounting processes: 3 | M | 0.6 | Nm |

Thermal Resistance

| Parameter | Symbol | Conditions | Max. Value | Unit |
|---|---------------|------------|------------|------|
| Characteristic | | | | |
| IGBT thermal resistance, junction - case | $R_{th(j-c)}$ | | 0.59 | K/W |
| Diode thermal resistance, junction - case | $R_{th(j-c)}$ | | 0.59 | K/W |
| Thermal resistance junction - ambient | $R_{th(j-a)}$ | | 55 | K/W |

Electrical Characteristic, at $T_{vj} = 25^{\circ}\text{C}$, unless otherwise specified

| Parameter | Symbol | Conditions | Value | | | Unit |
|--------------------------------------|---------------|--|-------------|----------------------|-----------------|---------------|
| | | | min. | typ. | max. | |
| Static Characteristic | | | | | | |
| Collector-emitter breakdown voltage | $V_{(BR)CES}$ | $V_{GE} = 0V, I_C = 0.50mA$ | 1200 | - | - | V |
| Collector-emitter saturation voltage | V_{CEsat} | $V_{GE} = 15.0V, I_C = 15.0A$ $T_{vj} = 25^{\circ}\text{C}$ $T_{vj} = 125^{\circ}\text{C}$ $T_{vj} = 175^{\circ}\text{C}$ | - - - | 1.48 1.70 1.80 | 1.70 - - | V |
| Diode forward voltage | V_F | $V_{GE} = 0V, I_F = 15.0A$ $T_{vj} = 25^{\circ}\text{C}$ $T_{vj} = 125^{\circ}\text{C}$ $T_{vj} = 175^{\circ}\text{C}$ | - - - | 1.55 1.70 1.80 | 1.75 - - | V |
| Gate-emitter threshold voltage | $V_{GE(th)}$ | $I_C = 0.40mA, V_{CE} = V_{GE}$ | 5.1 | 5.8 | 6.4 | V |
| Zero gate voltage collector current | I_{CES} | $V_{CE} = 1200V, V_{GE} = 0V$ $T_{vj} = 25^{\circ}\text{C}$ $T_{vj} = 175^{\circ}\text{C}$ | - - | - - | 100.0 2500.0 | μA |
| Gate-emitter leakage current | I_{GES} | $V_{CE} = 0V, V_{GE} = 20V$ | - | - | 100 | nA |
| Transconductance | g_{fs} | $V_{CE} = 20V, I_C = 15.0A$ | - | 13.9 | - | S |
| Integrated gate resistor | r_G | | | none | | Ω |

Electrical Characteristic, at $T_{vj} = 25^{\circ}\text{C}$, unless otherwise specified

| Parameter | Symbol | Conditions | Value | | | Unit |
|-------------------------------|-----------|---|-------|-------|------|------|
| | | | min. | typ. | max. | |
| Dynamic Characteristic | | | | | | |
| Input capacitance | C_{ies} | $V_{CE} = 25V, V_{GE} = 0V, f = 1MHz$ | - | 1165 | - | pF |
| Output capacitance | C_{oes} | | - | 40 | - | |
| Reverse transfer capacitance | C_{res} | | - | 32 | - | |
| Gate charge | Q_G | $V_{CC} = 960V, I_C = 15.0A,$ $V_{GE} = 15V$ | - | 165.0 | - | nC |

Switching Characteristic, Inductive Load, at $T_{vj} = 25^{\circ}\text{C}$

| Parameter | Symbol | Conditions | Value | | | Unit |
|----------------------------|--------------|--|-------|------|------|------|
| | | | min. | typ. | max. | |
| IGBT Characteristic | | | | | | |
| Turn-off delay time | $t_{d(off)}$ | $T_{vj} = 25^{\circ}\text{C}$, $V_{CC} = 600\text{V}$, $I_C = 15.0\text{A}$, $V_{GE} = 0.0/15.0\text{V}$, $r_G = 14.6\Omega$, $L_{\sigma} = 180\text{nH}$, $C_{\sigma} = 39\text{pF}$ L_{σ} , C_{σ} from Fig. E Energy losses include "tail" and diode reverse recovery. | - | 300 | - | ns |
| Fall time | t_f | | - | 46 | - | ns |
| Turn-off energy | E_{off} | | - | 0.70 | - | mJ |

 Switching Characteristic, Inductive Load, at $T_{vj} = 175^{\circ}\text{C}$

| Parameter | Symbol | Conditions | Value | | | Unit |
|----------------------------|--------------|---|-------|------|------|------|
| | | | min. | typ. | max. | |
| IGBT Characteristic | | | | | | |
| Turn-off delay time | $t_{d(off)}$ | $T_{vj} = 175^{\circ}\text{C}$, $V_{CC} = 600\text{V}$, $I_C = 15.0\text{A}$, $V_{GE} = 0.0/15.0\text{V}$, $r_G = 14.6\Omega$, $L_{\sigma} = 180\text{nH}$, $C_{\sigma} = 39\text{pF}$ L_{σ} , C_{σ} from Fig. E Energy losses include "tail" and diode reverse recovery. | - | 370 | - | ns |
| Fall time | t_f | | - | 90 | - | ns |
| Turn-off energy | E_{off} | | - | 1.25 | - | mJ |

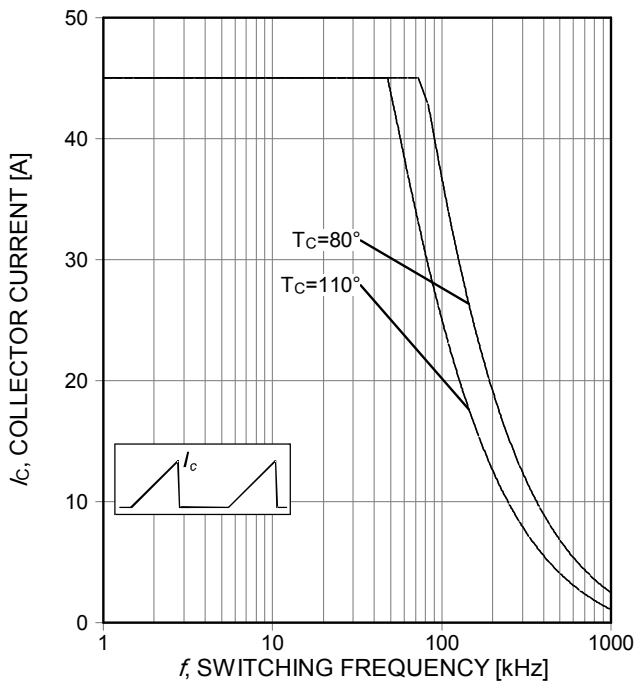

Figure 1. Collector current as a function of switching frequency
 ($T_j \leq 175^\circ\text{C}$, $D=0.5$, $V_{CE}=600\text{V}$, $V_{GE}=15/0\text{V}$, $R_G=14,6\Omega$)

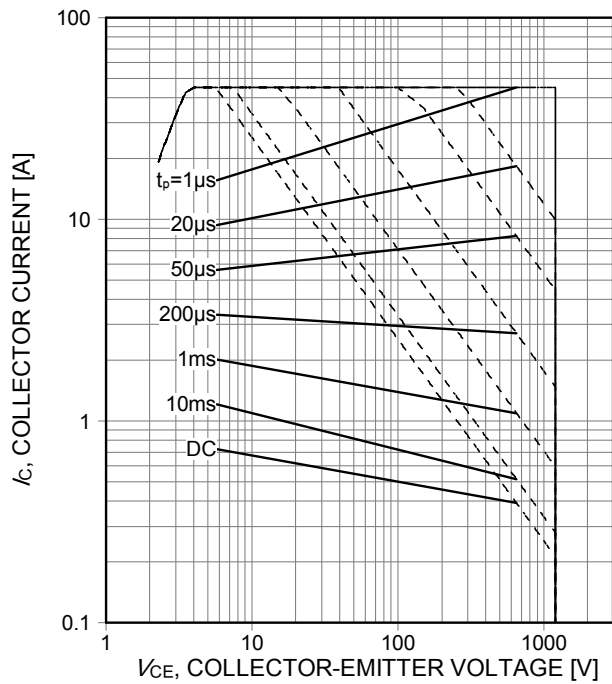

Figure 2. Forward bias safe operating area
 ($D=0$, $T_C=25^\circ\text{C}$, $T_j \leq 175^\circ\text{C}$; $V_{GE}=15\text{V}$)

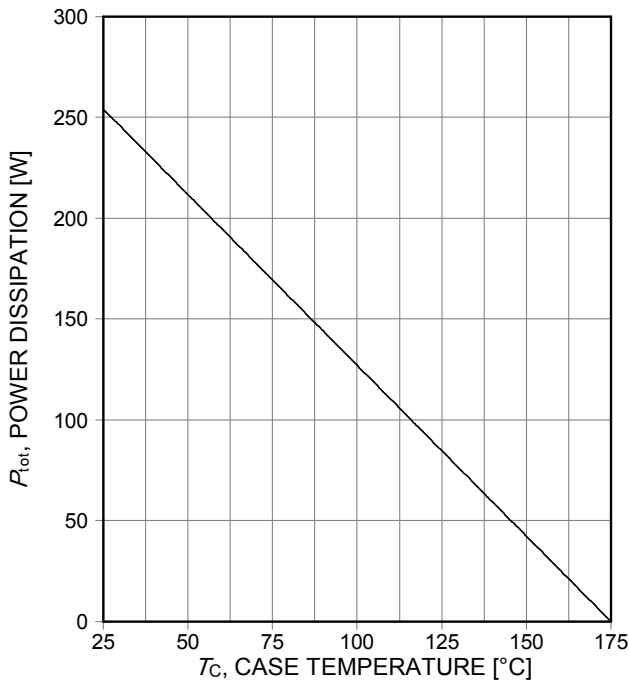

Figure 3. Power dissipation as a function of case temperature
 ($T_j \leq 175^\circ\text{C}$)

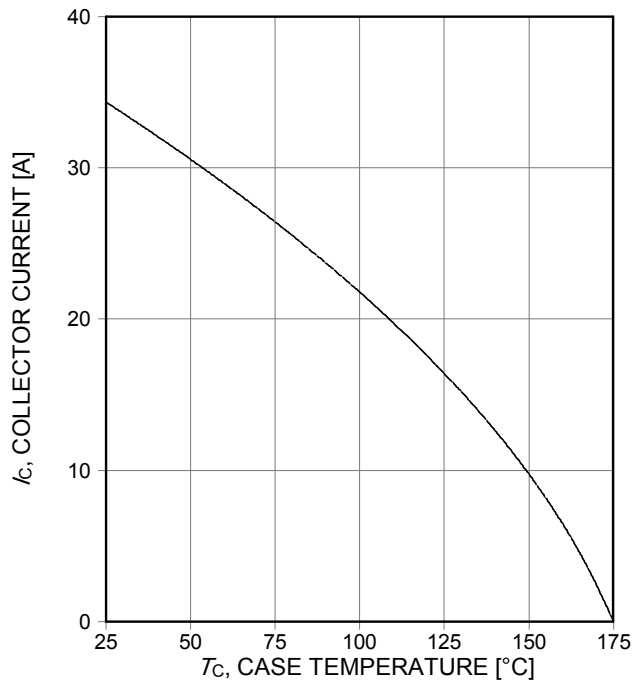

Figure 4. Collector current as a function of case temperature
 ($V_{GE} \geq 15\text{V}$, $T_j \leq 175^\circ\text{C}$)

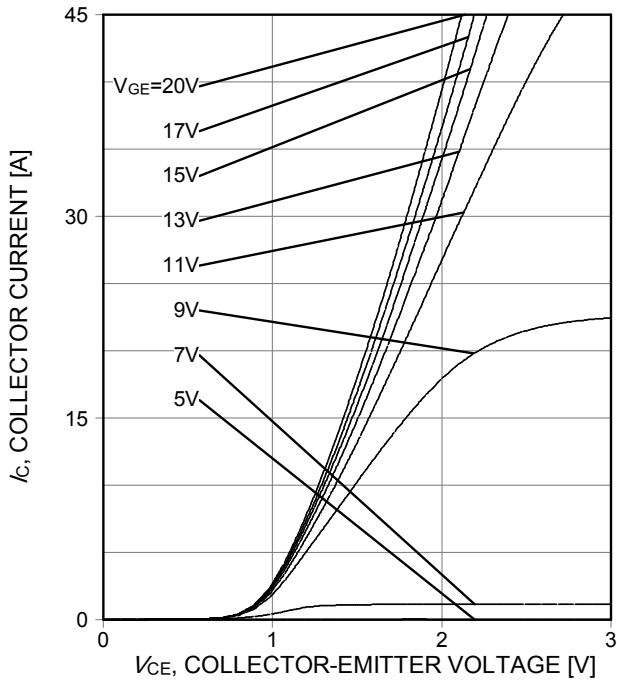

Figure 5. Typical output characteristic ($T_j=25^\circ\text{C}$)

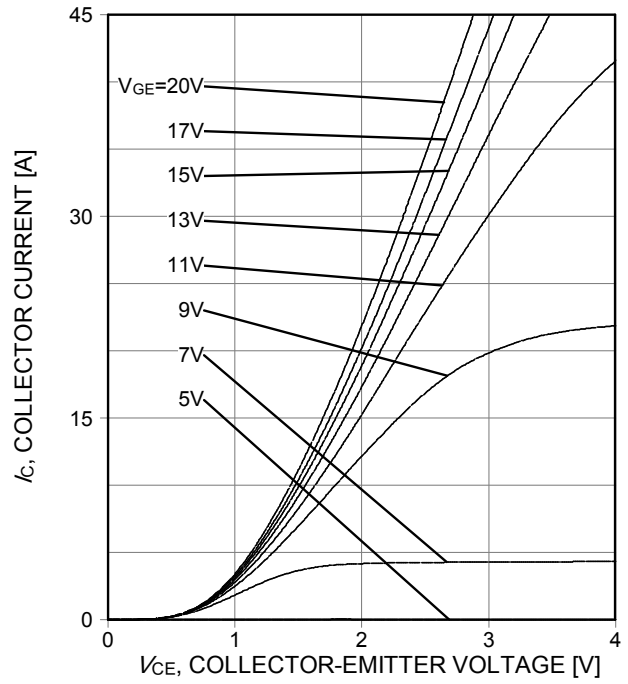

Figure 6. Typical output characteristic ($T_j=175^\circ\text{C}$)

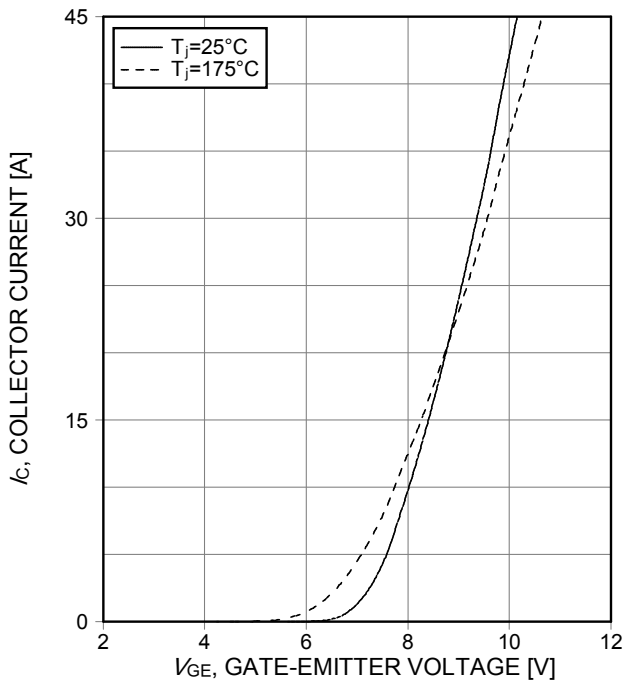

Figure 7. Typical transfer characteristic ($V_{CE}=20\text{V}$)

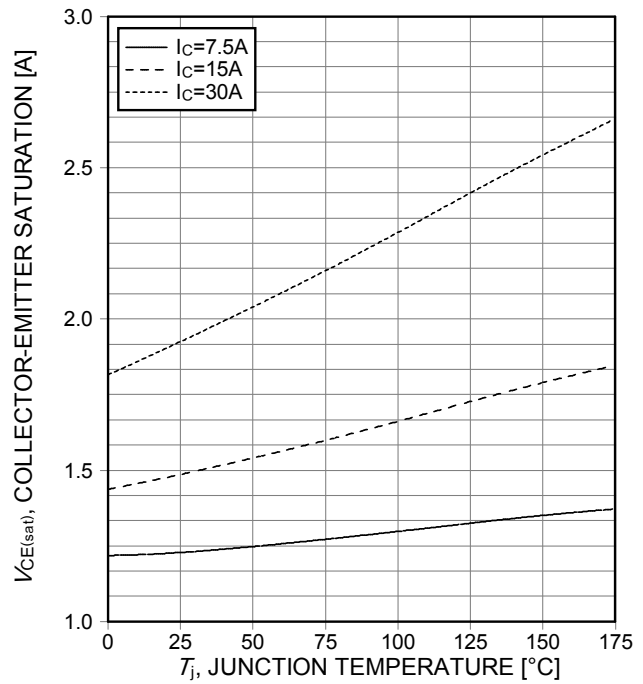

Figure 8. Typical collector-emitter saturation voltage as a function of junction temperature ($V_{GE}=15\text{V}$)

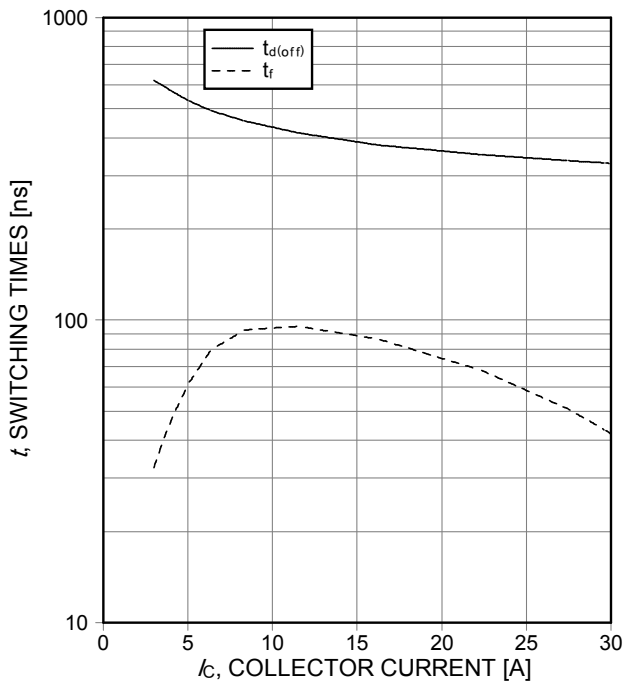

Figure 9. Typical switching times as a function of collector current
 (ind. load, $T_j=175^\circ\text{C}$, $V_{CE}=600\text{V}$, $V_{GE}=15/0\text{V}$, $R_G=14,6\Omega$, test circuit in Fig. E)

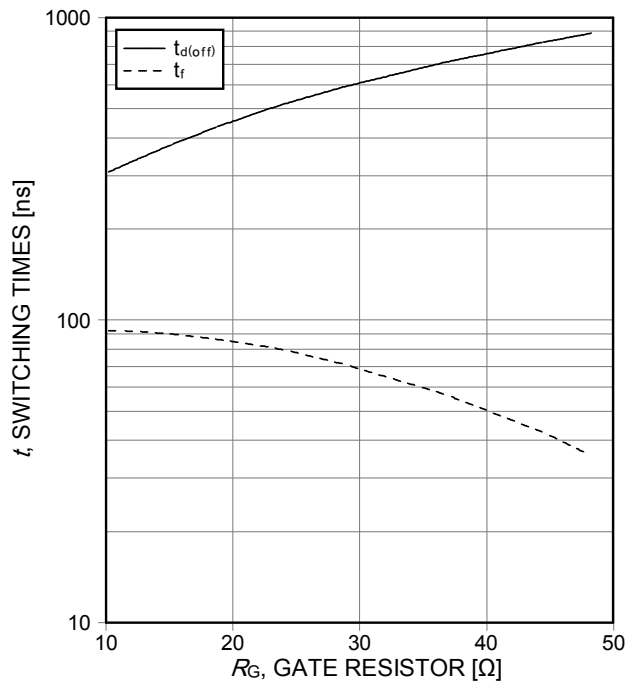

Figure 10. Typical switching times as a function of gate resistor
 (ind. load, $T_j=175^\circ\text{C}$, $V_{CE}=600\text{V}$, $V_{GE}=15/0\text{V}$, $I_C=15\text{A}$, test circuit in Fig. E)

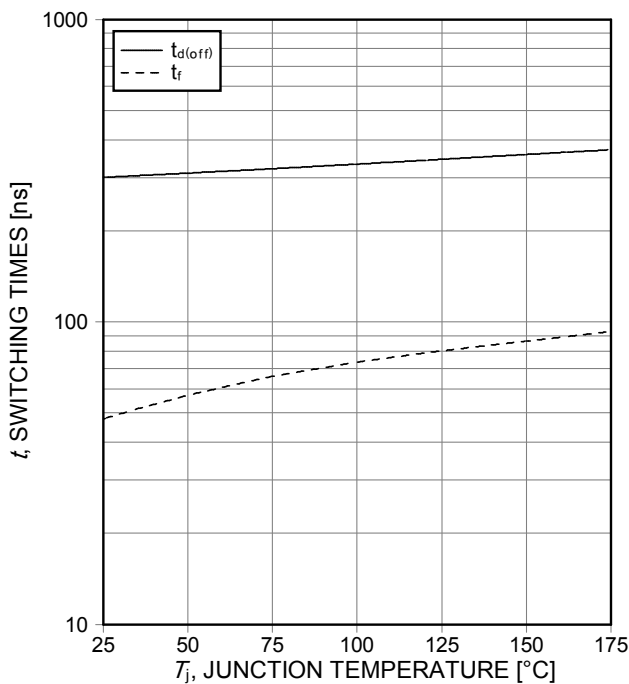

Figure 11. Typical switching times as a function of junction temperature
 (ind. load, $V_{CE}=600\text{V}$, $V_{GE}=15/0\text{V}$, $I_C=15\text{A}$, $R_G=14,6\Omega$, test circuit in Fig. E)

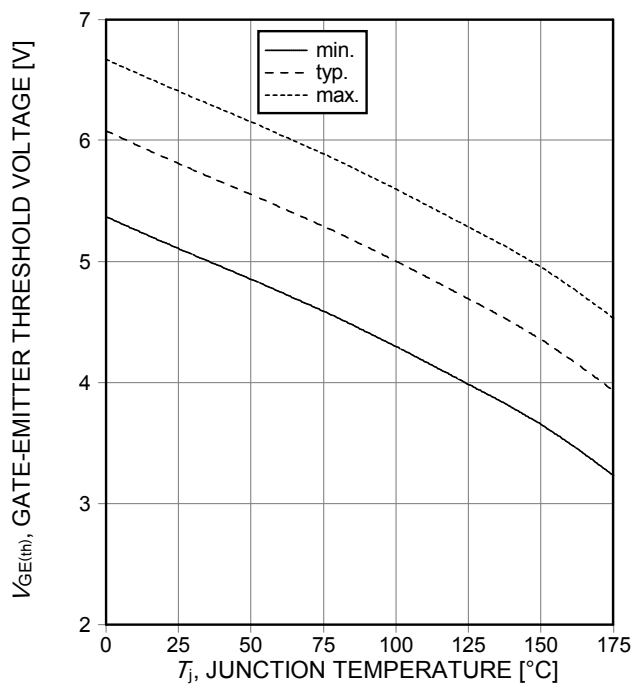

Figure 12. Gate-emitter threshold voltage as a function of junction temperature
 ($I_C=0.4\text{mA}$)

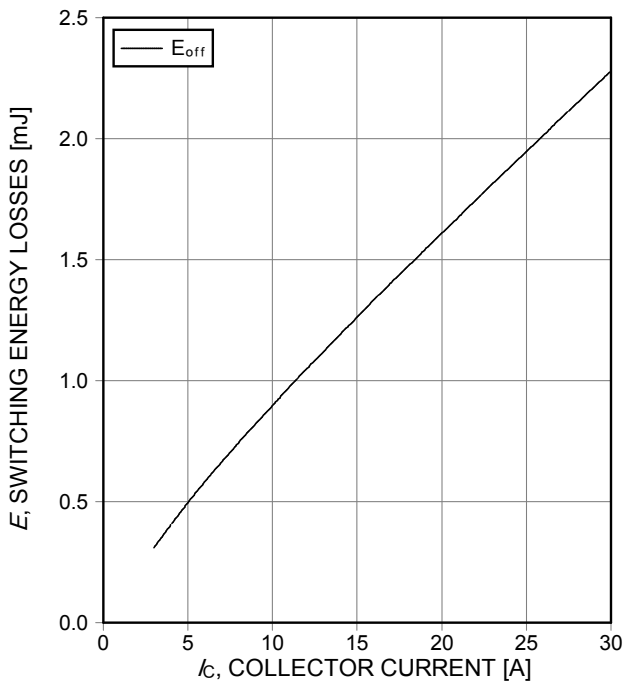

Figure 13. Typical switching energy losses as a function of collector current
 (ind. load, $T_j=175^\circ\text{C}$, $V_{CE}=600\text{V}$, $V_{GE}=15/0\text{V}$, $R_G=14,6\Omega$, test circuit in Fig. E)

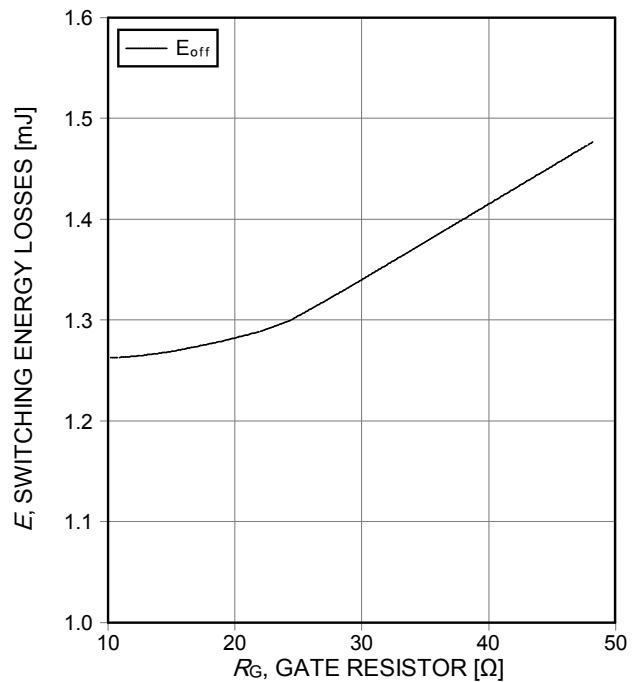

Figure 14. Typical switching energy losses as a function of gate resistor
 (ind. load, $T_j=175^\circ\text{C}$, $V_{CE}=600\text{V}$, $V_{GE}=15/0\text{V}$, $I_c=15\text{A}$, test circuit in Fig. E)

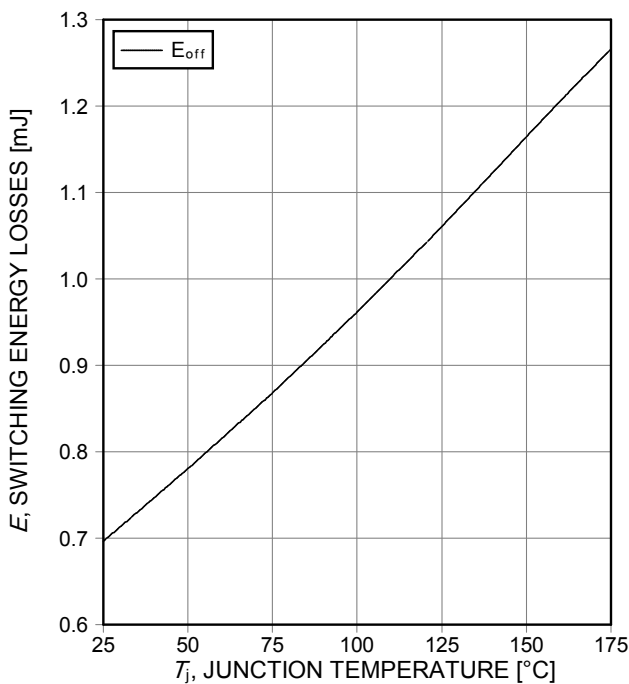

Figure 15. Typical switching energy losses as a function of junction temperature
 (ind. load, $V_{CE}=600\text{V}$, $V_{GE}=15/0\text{V}$, $I_c=15\text{A}$, $R_G=14,6\Omega$, test circuit in Fig. E)

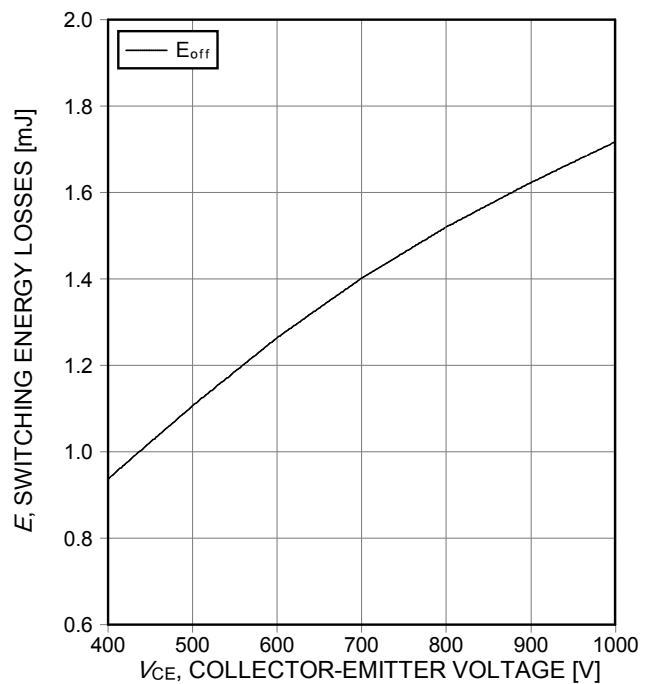

Figure 16. Typical switching energy losses as a function of collector emitter voltage
 (ind. load, $T_j=175^\circ\text{C}$, $V_{GE}=15/0\text{V}$, $I_c=15\text{A}$, $R_G=14,6\Omega$, test circuit in Fig. E)

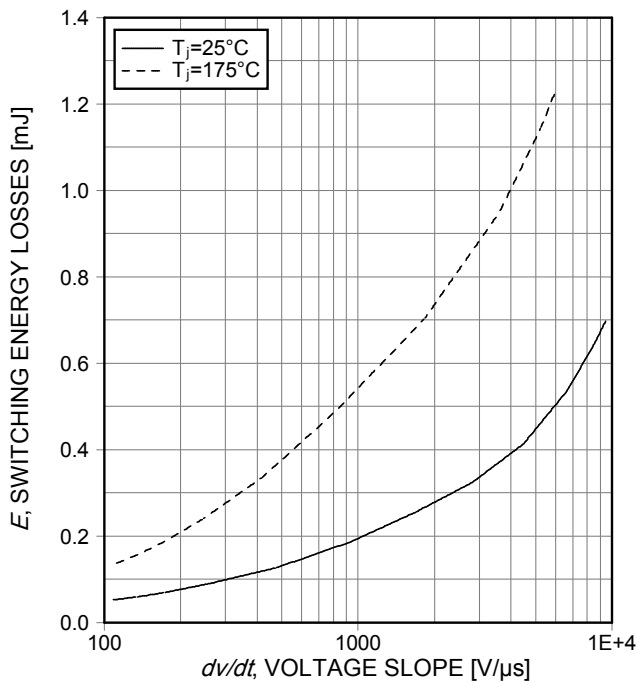

Figure 17. Typical turn off switching energy loss for soft switching
 (ind load, $V_{CE}=600V$, $V_{GE}=15/0V$, $I_C=15A$, $R_G=14,6\Omega$, test circuit in Fig. E)

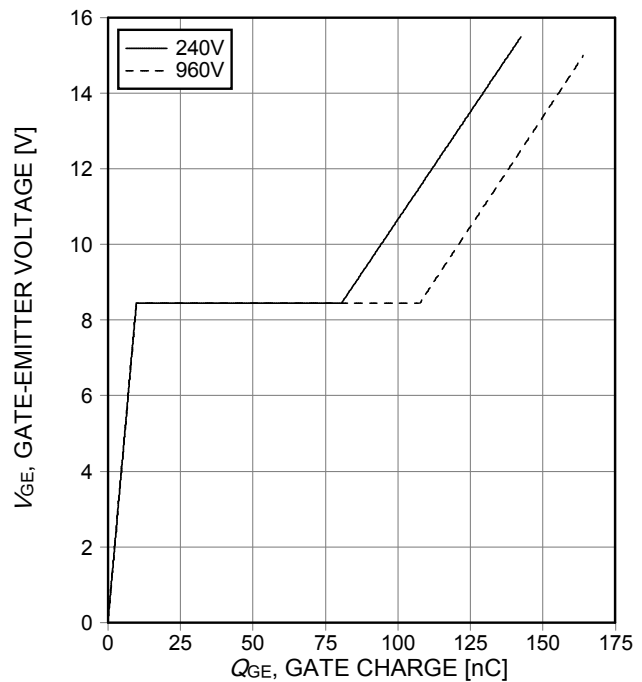

Figure 18. Typical gate charge
 ($I_C=15A$)

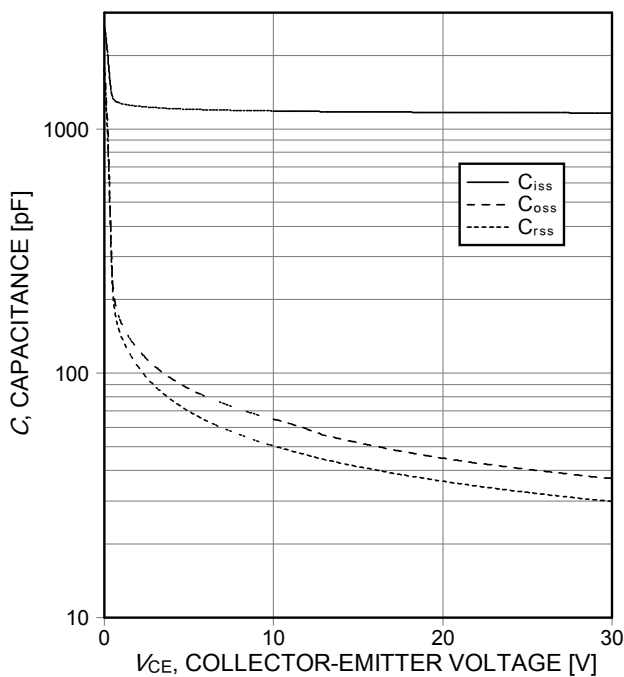

Figure 19. Typical capacitance as a function of collector-emitter voltage
 ($V_{GE}=0V$, $f=1MHz$)

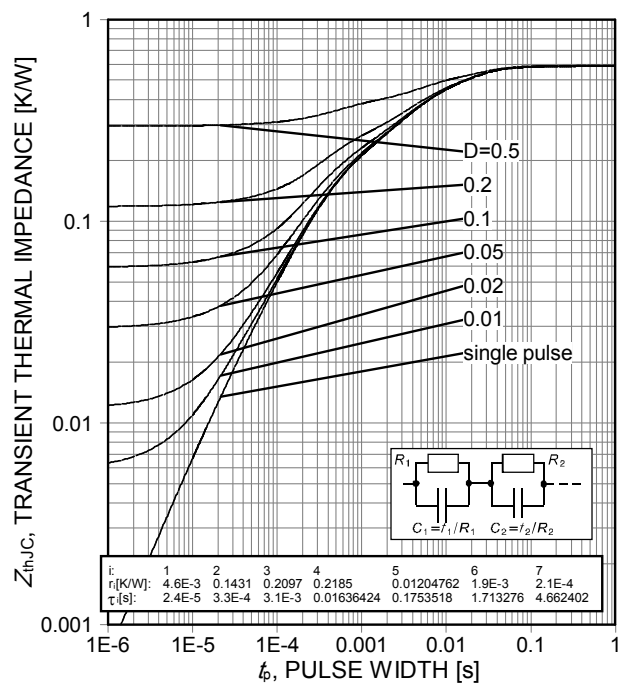

Figure 20. IGBT transient thermal impedance
 ($D=t_p/T$)

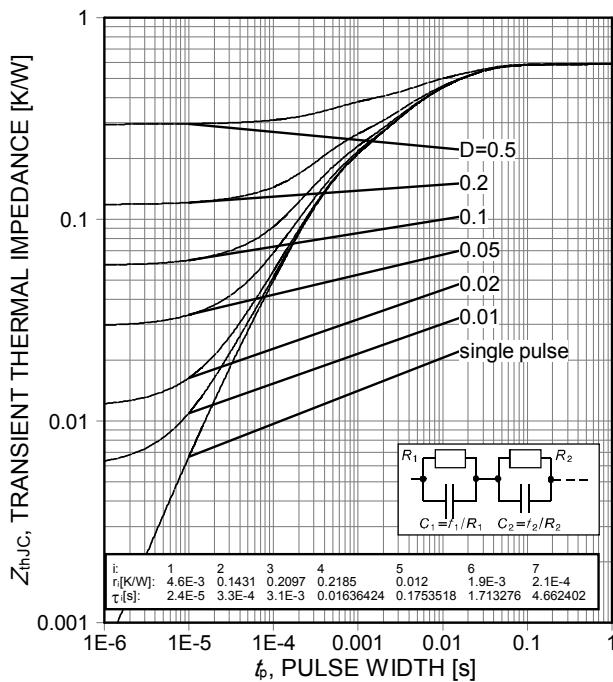

Figure 21. Diode transient thermal impedance as a function of pulse width ($D = t_p/T$)

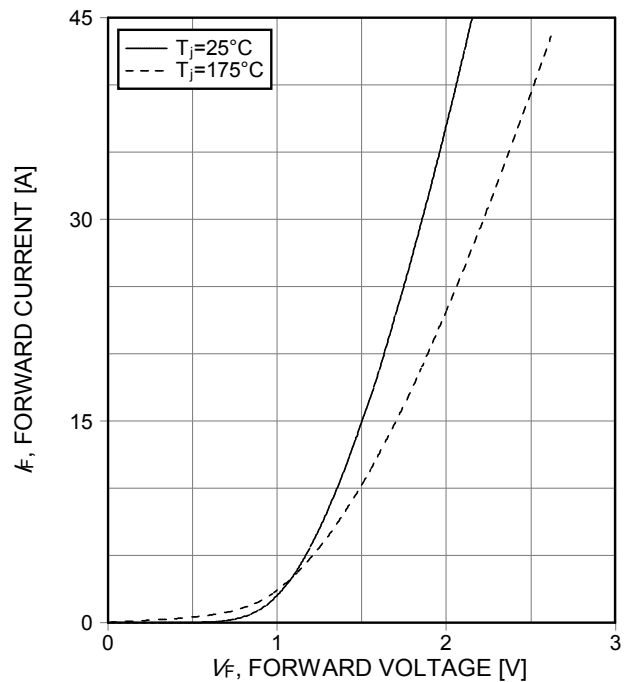

Figure 22. Typical diode forward current as a function of forward voltage

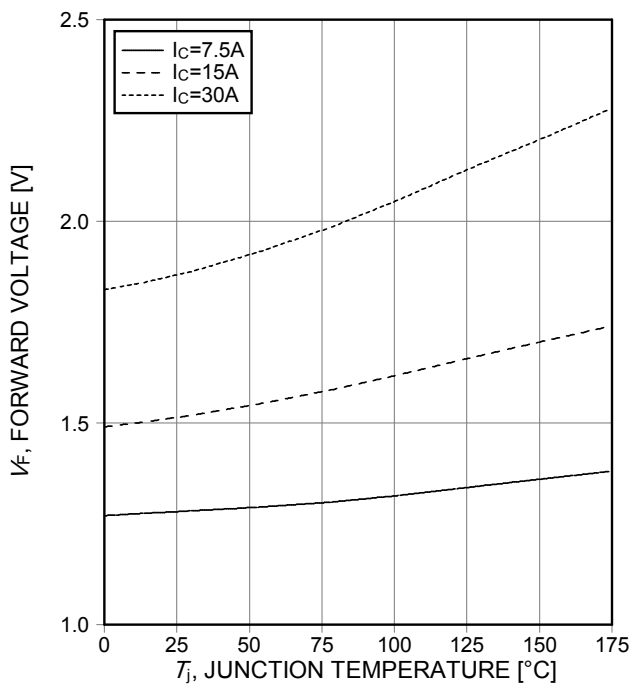
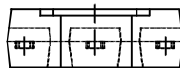
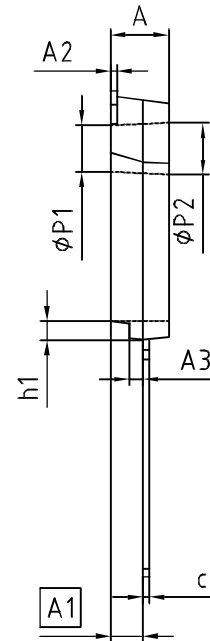
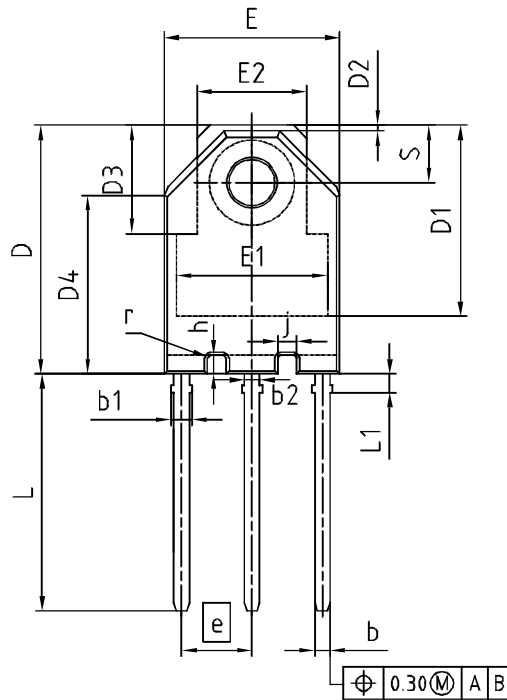

Figure 23. Typical diode forward voltage as a function of junction temperature

PG-TO247HC-3 (PG-TOHC-3)



| DIM | MILLIMETERS | | INCHES | |
|-----|-------------|-------|-----------|-------|
| | MIN | MAX | MIN | MAX |
| A | 4.40 | 4.60 | 0.173 | 0.181 |
| A1 | 2.40 | 2.60 | 0.094 | 0.102 |
| A2 | 0.40 | 0.60 | 0.016 | 0.024 |
| A3 | 0.95 | 1.15 | 0.037 | 0.045 |
| b | 1.10 | 1.30 | 0.043 | 0.051 |
| b1 | 1.50 | 1.70 | 0.059 | 0.067 |
| b2 | 1.10 | 1.30 | 0.043 | 0.051 |
| c | 0.40 | 0.60 | 0.016 | 0.024 |
| D | 19.05 | 19.45 | 0.750 | 0.766 |
| D1 | 14.69 | 14.89 | 0.578 | 0.586 |
| D2 | 0.35 | 0.55 | 0.014 | 0.022 |
| D3 | 8.30 | 8.50 | 0.327 | 0.335 |
| D4 | 13.51 | 14.11 | 0.532 | 0.556 |
| E | 13.40 | 13.80 | 0.528 | 0.543 |
| E1 | 11.60 | 11.80 | 0.457 | 0.465 |
| E2 | 8.30 | 8.70 | 0.327 | 0.343 |
| e | 5.45 | | 0.215 | |
| N | 3 | | 3 | |
| L | 18.05 | 18.65 | 0.711 | 0.734 |
| L1 | 1.35 | 1.55 | 0.053 | 0.061 |
| øP1 | 3.51 | 3.71 | 0.138 | 0.146 |
| øP2 | 4.00 | 4.10 | 0.157 | 0.161 |
| S | 4.35 | 4.55 | 0.171 | 0.179 |
| j | 1.35 | 1.55 | 0.053 | 0.061 |
| h | 1.35 | 1.55 | 0.053 | 0.061 |
| r | max 0.2 | | max 0.008 | |
| h1 | 1.35 | 1.55 | 0.053 | 0.061 |

DOCUMENT NO.
Z8B00151733

SCALE

EUROPEAN PROJECTION

ISSUE DATE
11-03-2009

REVISION
01

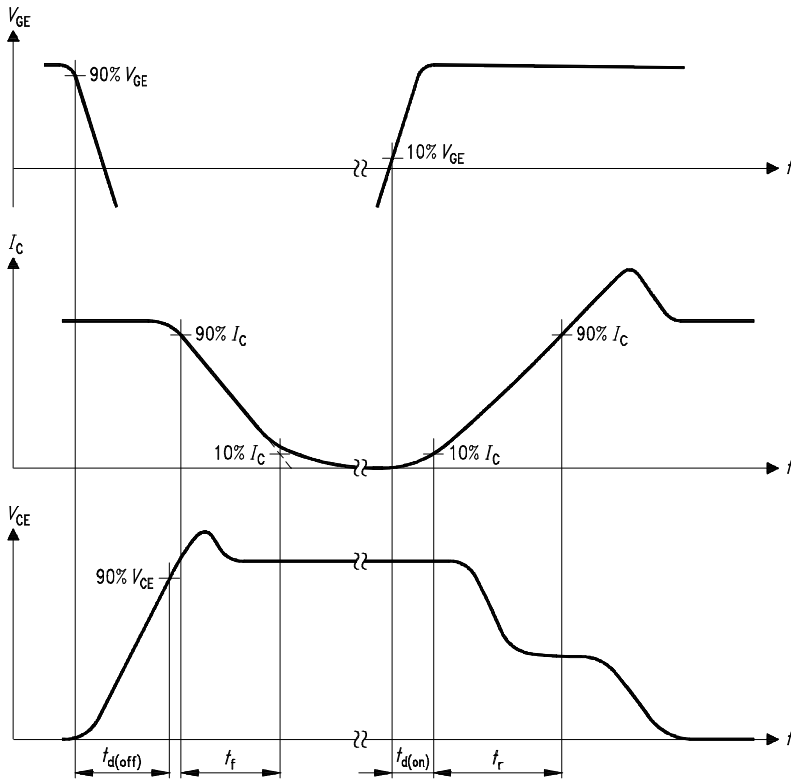

Figure A. Definition of switching times

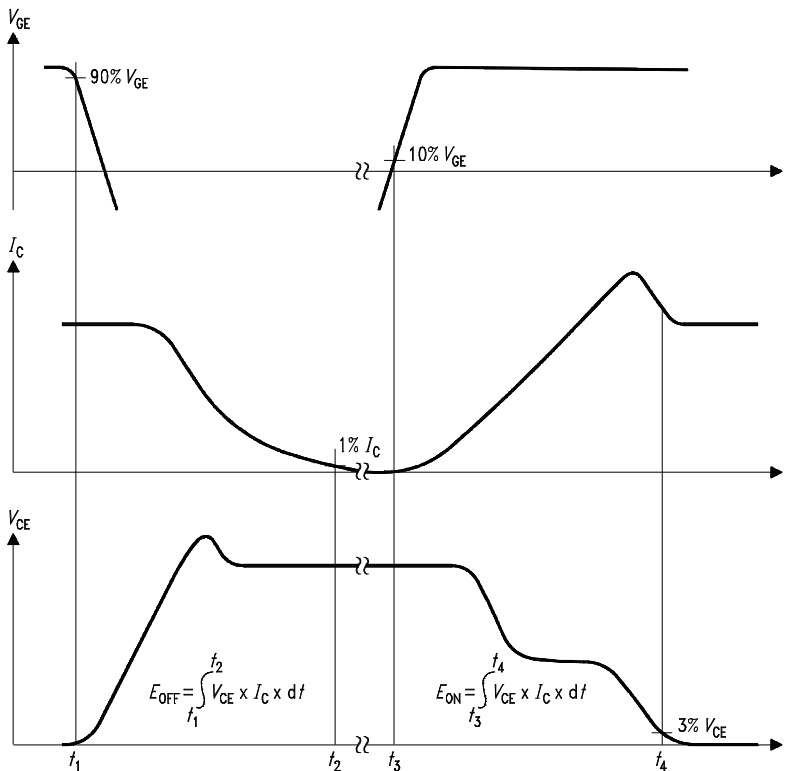

Figure B. Definition of switching losses

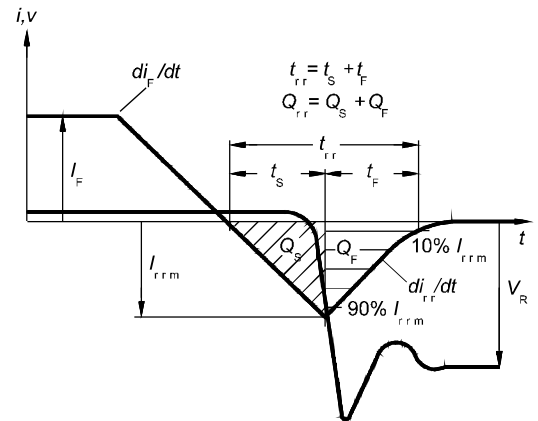

Figure C. Definition of diodes switching characteristics

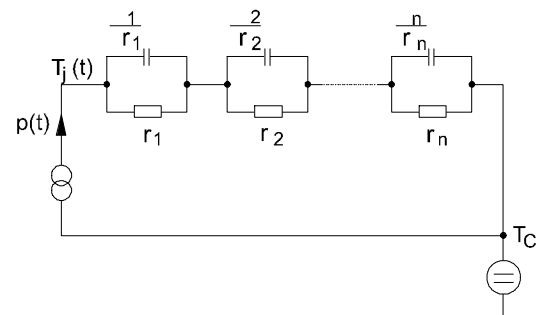

Figure D. Thermal equivalent circuit

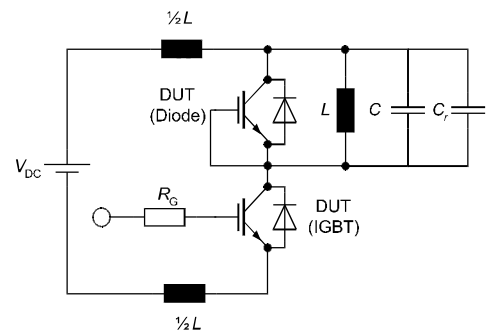

Figure E. Dynamic test circuit
 Leakage inductance $L = 180\text{nH}$,
 Stray capacitor $C_s = 40\text{pF}$,
 Relief capacitor $C_r = 1\text{nF}$
 (only for ZVT switching)

Published by
Infineon Technologies AG
81726 Munich, Germany
81726 München, Germany
© 2009 Infineon Technologies AG
All Rights Reserved.

Legal Disclaimer

The information given in this document shall in no event be regarded as a guarantee of conditions or characteristics. With respect to any examples or hints given herein, any typical values stated herein and/or any information regarding the application of the device, Infineon Technologies hereby disclaims any and all warranties and liabilities of any kind, including without limitation, warranties of non-infringement of intellectual property rights of any third party.

Information

For further information on technology, delivery terms and conditions and prices, please contact the nearest Infineon Technologies Office (www.infineon.com).

Warnings

Due to technical requirements, components may contain dangerous substances. For information on the types in question, please contact the nearest Infineon Technologies Office. Infineon Technologies components may be used in life-support devices or systems only with the express written approval of Infineon Technologies, if a failure of such components can reasonably be expected to cause the failure of that life-support device or system or to affect the safety or effectiveness of that device or system. Life support devices or systems are intended to be implanted in the human body or to support and/or maintain and sustain and/or protect human life. If they fail, it is reasonable to assume that the health of the user or other persons may be endangered.