

# FME270-461 EMI Input Filters

## 270 VOLT INPUT – 1.5 AMP

### FEATURES

#### Attenuation to 50 dB at 500 kHz

- Operating temperature -55° to +125°C
- Nominal 270 V input, 0 to 400 V operation
- Transient rating to 500 V for 100 ms
- Up to 1.5 A throughput current
- Compliant to
  - MIL-STD-461C, CE03



### DESCRIPTION

The FME270 Series™ EMI filters are specifically designed to reduce the reflected input ripple current of Interpoint's high frequency DC/DC converters. FME270 filters minimize electromagnetic interference (EMI) for the MHP270 Series of converters. These filters are intended for use in 270 volt applications which must meet MIL-STD-461C CE03 levels of conducted emissions. One filter can be used with multiple converters up to the rated output current of the filter.

### INPUT RIPPLE AND EMI

Switching DC/DC converters naturally generate two noise components on the power input line: differential noise and common mode noise. Input ripple current refers to both of these components. Differential noise occurs between the positive input and input common. Most Interpoint converters have an input filter that reduces differential noise which is sufficient for many applications. Common mode noise occurs across stray capacitances between the converter's power train components and the baseplate (bottom of the package) of the converter.

Where low noise currents are required to meet MIL-STD-461C, a power line filter is needed. The FME270 EMI power line filters reduces the common mode and differential noise generated by the converters. FME270 filters reduce input ripple current by as much as 50 dB at 500 kHz and 55 dB at 1 MHz when used in conjunction with Interpoint's DC/DC converters.

Place the filter as close as possible to the converter for optimum performance. The baseplates of the filter and the converter should be connected with the shortest and widest possible conductors.

### TRANSIENTS

A transient of -500 to +500 V for up to 100 ms will not damage the filter but will be passed on to the converter:

### OPERATION OVER TEMPERATURE

The FME270-461 Series filters are rated for full power operation from -55°C to +125°C case temperature. Current is derated linearly to zero at +135°C case temperature.

### INSERTION LOSS

The maximum dc insertion loss at full load and nominal input voltage represents a power loss of less than 4%.

### PACKAGING

FME270-461 filters are sealed in metal hermetic side-leaded packages. See cases U, V, W, Y, and Z.

# FME270-461 EMI Input Filters

## 270 VOLT INPUT – 1.5 AMP

### OPERATING CONDITIONS AND CHARACTERISTICS

#### Input Voltage Range

- 0 to 400 VDC continuous
- Transient -500 to +500 volts for 100 ms

#### Lead Soldering Temperature (10 sec per lead)

- 300°C

#### Storage Temperature Range (T<sub>C</sub>)

- -65°C to +150°C

#### Case Operating Temperature (T<sub>C</sub>)

- -55°C to +125°C full power
- -55°C to +135°C absolute

#### Derating Input/Output Current (T<sub>C</sub>)

- Linearly from 100% at 125°C to zero at 135°C

#### Isolation

- 100 megohm minimum at 500 VDC
- Any pin to case

### MECHANICAL AND ENVIRONMENTAL

#### Size (maximum)

- Case U  
3.005 x 1.505 x 0.400 inches (76.33 x 38.23 x 10.16 mm)  
The image on page one shows Case U (flanged, short leads).
- Also available:
  - Flanged: leads bent down (case V)
  - Tabbed: leads bent up (case W)
  - Tabbed: short leads (case Y)
  - Tabbed: leads bent down (case Z).
- See cases U, V, W, Y, and Z for dimensions and options.

#### Weight (maximum)

- 77 grams typical cases U, V, W, Y, and Z

#### Screening

The FME270 EMI Input filter offers Standard or /ES screening. See Standard and /ES (non-QML) screening table for more information on page 11.

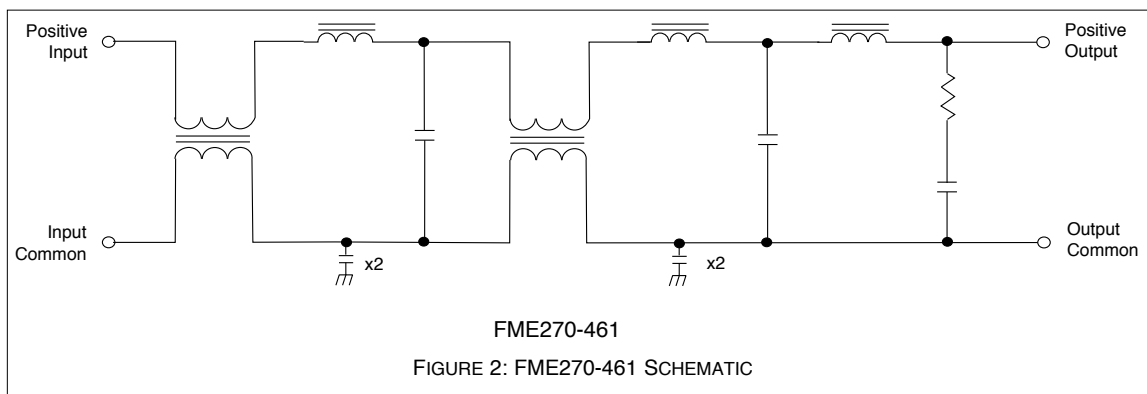
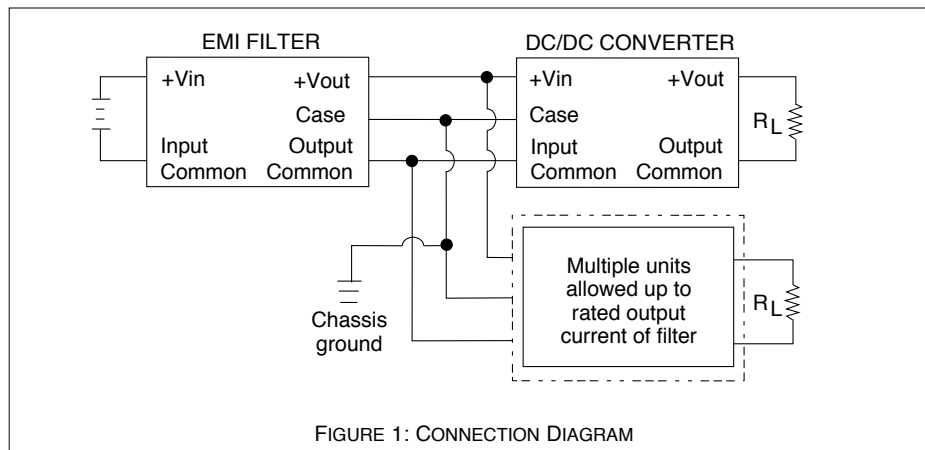

# FME270-461 EMI Input Filters

## 270 VOLT INPUT – 1.5 AMP

### PIN OUT

Pin 1	Designation
1, 2, 3	Positive Input
4, 5, 6	Input Common
7, 8, 9	Output Common
10, 11, 12	Positive Output
—	Case Ground <sup>2</sup>

- Notes
1. All pins must be connected.
  2. The baseplate is the only case ground connection and should directly contact chassis ground.

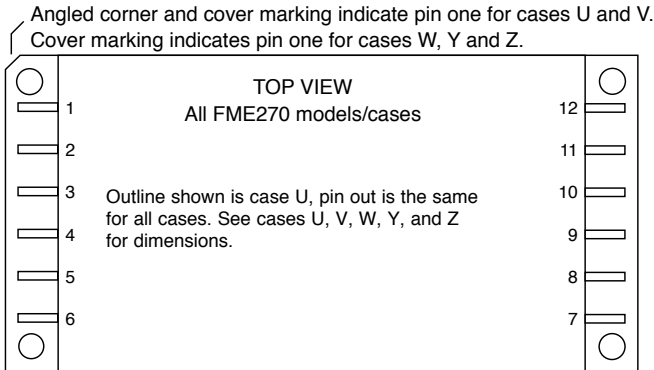
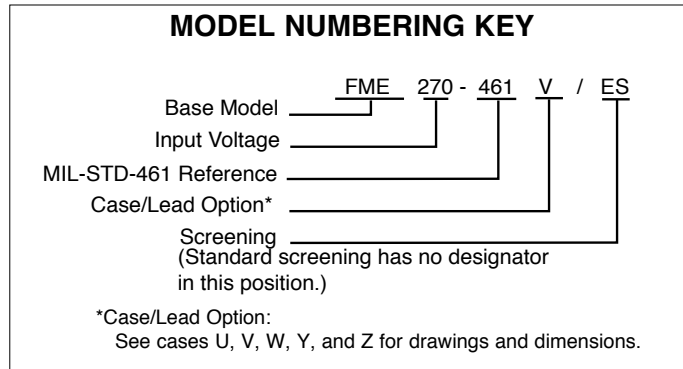

FIGURE 3: PIN OUT

# FME270-461 EMI Input Filters

## 270 VOLT INPUT – 1.5 AMP



<b>MODEL SELECTION</b>					
ON THE LINES BELOW, ENTER ONE SELECTION FROM UNDER EACH CATEGORY TO DETERMINE THE MODEL NUMBER.					
CATEGORY	FME270 BASE MODEL AND INPUT VOLTAGE	-461 MIL-STD-461 REFERENCE	_____ CASE/LEAD OPTION <sup>1</sup>	/	_____ SCREENING <sup>2</sup>
<b>SELECTION</b>	“FME270” is the only available selection	“-461” is the only available selection	U (leave blank) V W Y Z		Standard (leave blank)  ES
Notes: 1. Case U is the standard, side-leaded, flanged case. Leave the option blank for case U. Refer to the case drawings on pages 7 - 10 for other case options. 2. Leave blank for standard screening. Use “ES” for “ES” screening. See page 11 for more information.					

# FME270-461 EMI Input Filters

## 270 VOLT INPUT – 1.5 AMP

Electrical Characteristics: 25°C T<sub>C</sub> , nominal Vin, unless otherwise specified.

MODEL		FME270-461			UNITS
PARAMETER	CONDITIONS	MIN	TYP	MAX	
INPUT VOLTAGE	CONTINUOUS	0	270	400	VDC
	TRANSIENT 100 ms <sup>1</sup>	-500	—	500	V
NOISE REJECTION	500 KHZ	40	50	—	dB
	1 MHZ	45	55	—	
DC RESISTANCE (R <sub>DC</sub> ) AT MAXIMUM CURRENT <sup>1</sup>	T <sub>C</sub> = 25°C	—	—	2.0	Ω
	T <sub>C</sub> = 125°C	—	—	3.2	
CAPACITANCE <sup>1</sup>	ANY PIN TO CASE	—	60,000		pF
OUTPUT VOLTAGE	STEADY STATE	V <sub>OUT</sub> = V <sub>IN</sub> - I <sub>IN</sub> (R <sub>DC</sub> )			VDC
OUTPUT CURRENT	STEADY STATE	—	—	1.5	A
POWER DISSIPATION AT MAXIMUM CURRENT <sup>1</sup>	T <sub>C</sub> = 25°C	—	—	4.5	W
	T <sub>C</sub> = 125°C <sup>1</sup>	—	—	7.2	

Note

1. Guaranteed by design, not tested.

# FME270-461 EMI Input Filters – Cases

## 270 VOLT INPUT – 1.5 AMP

### TOP VIEW CASE U\* Flanged case, short-leaded

\*Does not require designator in Case Option position of model number.

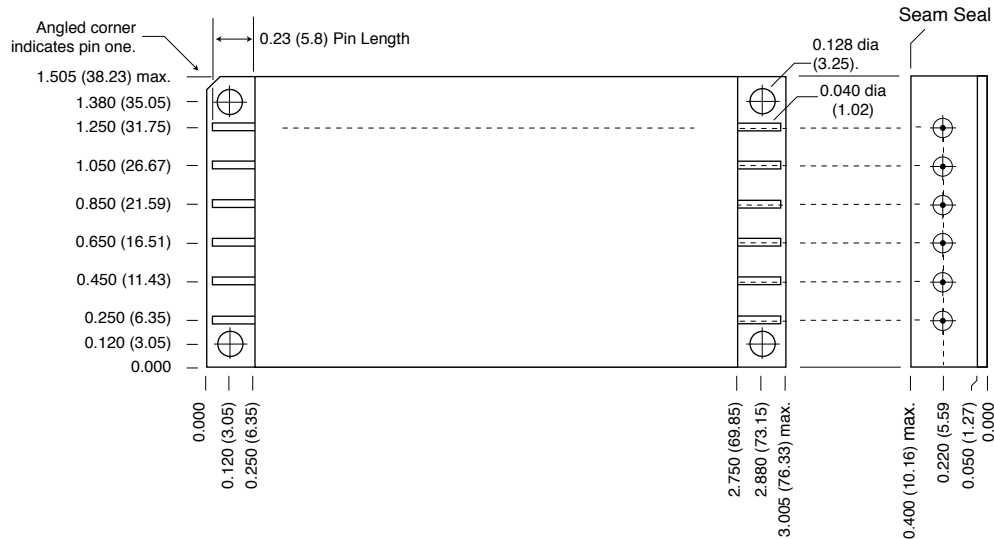

#### Case dimensions in inches (mm)

Tolerance  $\pm 0.005$  (0.13) for three decimal places  
 $\pm 0.01$  (0.3) for two decimal places  
 unless otherwise specified

#### CAUTION

Heat from reflow or wave soldering may damage the device. Solder pins individually with heat application not exceeding 300°C for 10 seconds per pin.

#### Materials

Header Cold Rolled Steel/Nickel/Gold  
 Cover Kovar/Nickel  
 Pins #52 alloy/Gold, compression glass seal  
 Seal Hole:  $0.100 \pm 0.002$  ( $2.54 \pm 0.05$ )

Case U, Rev E, 20100401

Please refer to the numerical dimensions for accuracy. All information is believed to be accurate, but no responsibility is assumed for errors or omissions. Interpoint reserves the right to make changes in products or specifications without notice.  
 Copyright © 1999-2010 Interpoint Corp. All rights reserved.

FIGURE 4: CASE U - FME270-461

# FME270-461 EMI Input Filters – Cases

## 270 VOLT INPUT – 1.5 AMP

### TOP VIEW CASE V\*

Flanged case, down leaded

\*Designator "V" required in Case Option position of model number.

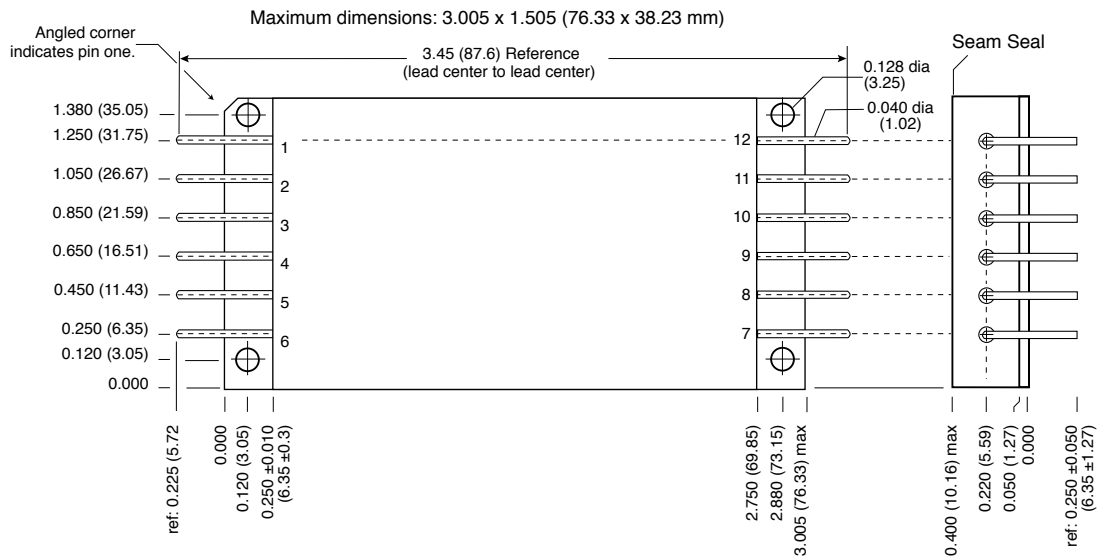

#### Case dimensions in inches (mm)

Tolerance  $\pm 0.005$  (0.13) for three decimal places  
 $\pm 0.01$  (0.3) for two decimal places  
 unless otherwise specified

#### CAUTION

Heat from reflow or wave soldering may damage the device. Solder pins individually with heat application not exceeding 300°C for 10 seconds per pin.

#### Materials

Header Cold Rolled Steel/Nickel/Gold  
 Cover Kovar/Nickel  
 Pins #52 alloy/Gold, compression glass seal  
 Seal Hole: 0.120  $\pm$  0.002 (3.05  $\pm$  0.05)

Case V, Rev E, 20100106

Please refer to the numerical dimensions for accuracy. All information is believed to be accurate, but no responsibility is assumed for errors or omissions. Interpoint reserves the right to make changes in products or specifications without notice.  
 Copyright © 1999-2009 Interpoint Corp. All rights reserved.

FIGURE 5: CASE V - FME270-461V

# FME270-461 EMI Input Filters – Cases

## 270 VOLT INPUT – 1.5 AMP

### TOP VIEW CASE W\*

Tabbed case, up-leaded

\*Designator "W" required in Case Option position of model number.

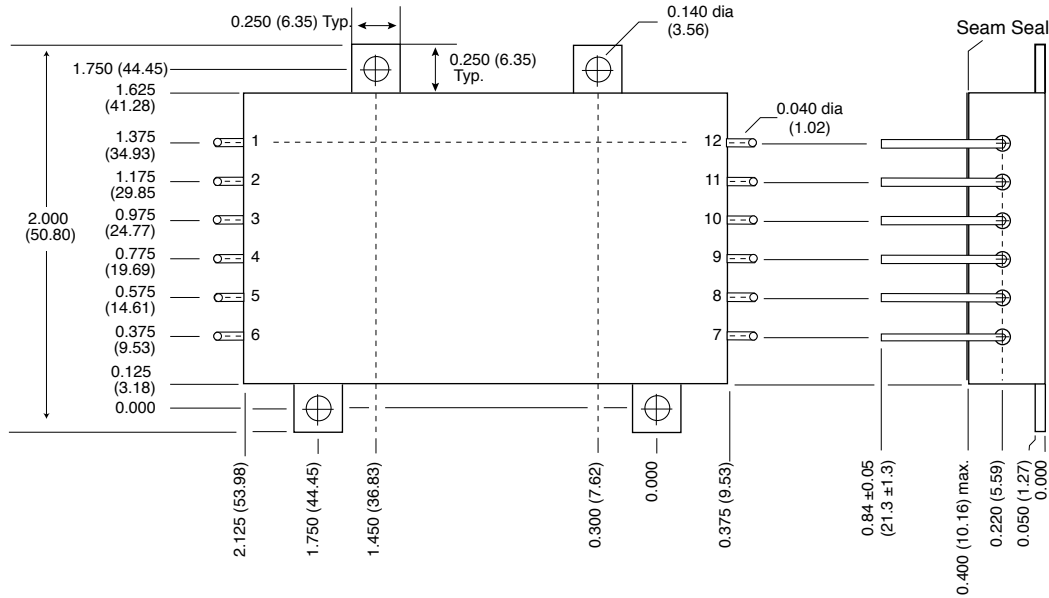

**Case dimensions in inches (mm)**

Tolerance  $\pm 0.005$  (0.13) for three decimal places  
 $\pm 0.01$  (0.3) for two decimal places  
 unless otherwise specified

**CAUTION**

Heat from reflow or wave soldering may damage the device. Solder pins individually with heat application not exceeding 300°C for 10 seconds per pin.

**Materials**

- Header Cold Rolled Steel/Nickel/Gold
- Cover Kovar/Nickel
- Pins #52 alloy/Gold, compression glass seal
- Seal Hole:  $0.120 \pm 0.002$  ( $3.05 \pm 0.05$ )

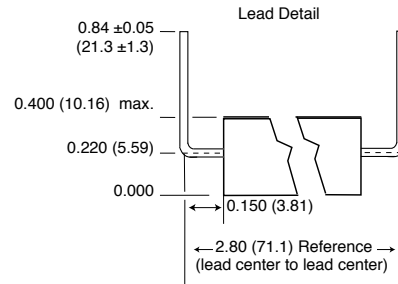

Case W, Rev E, 20100401  
 Please refer to the numerical dimensions for accuracy. All information is believed to be accurate, but no responsibility is assumed for errors or omissions. Interpoint reserves the right to make changes in products or specifications without notice.  
 Copyright © 1999-2010 Interpoint Corp. All rights reserved.

FIGURE 6: CASE W - FME270-461W



# FME270-461 EMI Input Filters – Cases

## 270 VOLT INPUT – 1.5 AMP

### TOP VIEW CASE Y\* Tabbed case, straight-leaded

\*Designator "Y" required in Case Option position of model number.

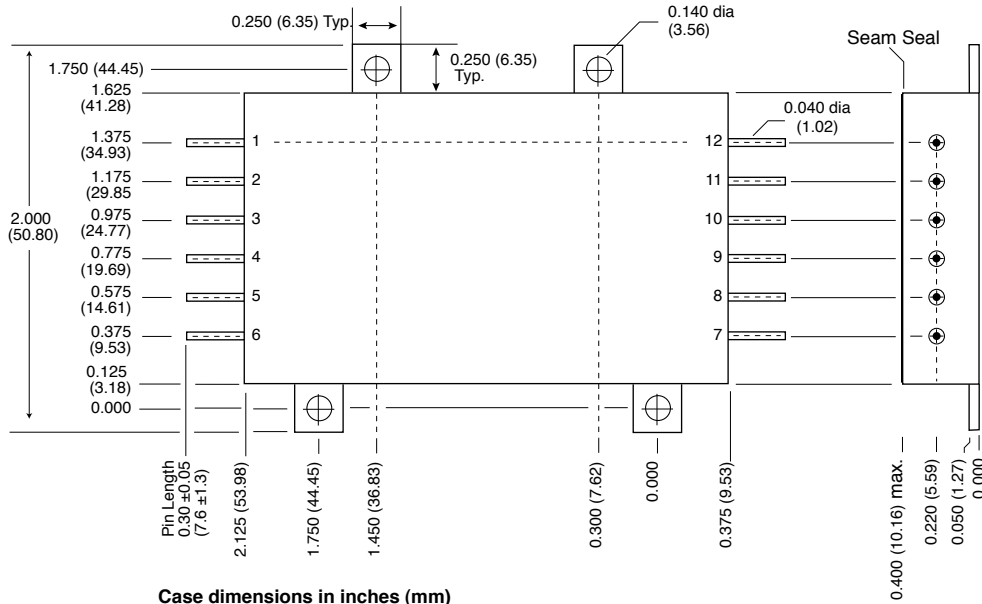

**Case dimensions in inches (mm)**

Tolerance  $\pm 0.005$  (0.13) for three decimal places  
 $\pm 0.01$  (0.3) for two decimal places  
 unless otherwise specified

**CAUTION**

Heat from reflow or wave soldering may damage the device. Solder pins individually with heat application not exceeding 300°C for 10 seconds per pin.

**Materials**

- Header Cold Rolled Steel/Nickel/Gold
- Cover Kovar/Nickel
- Pins #52 alloy/Gold, compression glass seal
- Seal Hole:  $0.120 \pm 0.002$  ( $3.05 \pm 0.05$ )

**Lead Detail**

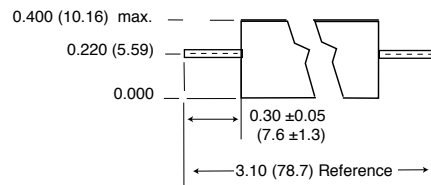

Case Y, Rev E, 20100401

Please refer to the numerical dimensions for accuracy. All information is believed to be accurate, but no responsibility is assumed for errors or omissions. Interpoint reserves the right to make changes in products or specifications without notice. Copyright © 1999-2010 Interpoint Corp. All rights reserved.

FIGURE 7: CASE Y - FME270-461Y

# FME270-461 EMI Input Filters – Cases

## 270 VOLT INPUT – 1.5 AMP

### TOP VIEW CASE Z\* Tabbed case, down-leaded

\*Designator "Z" required in Case Option position of model number.

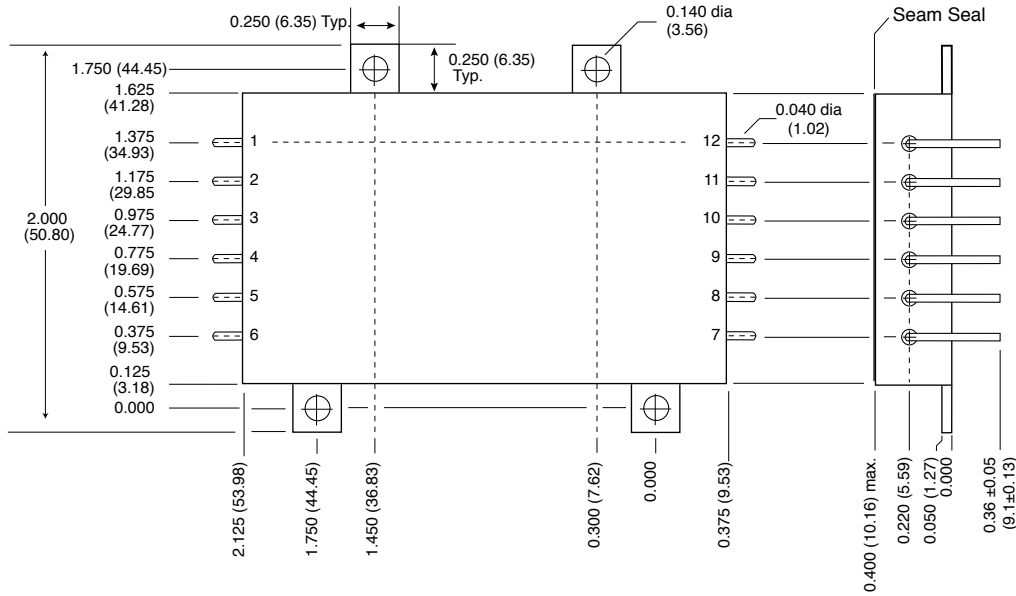

**Case dimensions in inches (mm)**

Tolerance  $\pm 0.005$  (0.13) for three decimal places  
 $\pm 0.01$  (0.3) for two decimal places  
 unless otherwise specified

**CAUTION**

Heat from reflow or wave soldering may damage the device. Solder pins individually with heat application not exceeding 300°C for 10 seconds per pin.

**Materials**

- Header Cold Rolled Steel/Nickel/Gold
- Cover Kovar/Nickel
- Pins #52 alloy/Gold, compression glass seal
- Seal Hole: 0.120  $\pm$  0.002 (3.05  $\pm$  0.05)

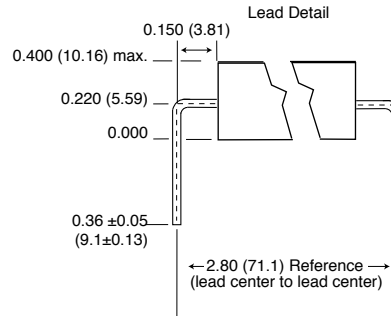

Case Z, Rev E, 20100401

Please refer to the numerical dimensions for accuracy. All information is believed to be accurate, but no responsibility is assumed for errors or omissions. Interpoint reserves the right to make changes in products or specifications without notice. Copyright © 1999-2010 Interpoint Corp. All rights reserved.

FIGURE 8: CASE Z - FME270-461Z

# FME270-461 EMI Input Filters

## 270 VOLT INPUT – 1.5 AMP

### STANDARD AND /ES (NON-QML) PRODUCTS ENVIRONMENTAL SCREENING <sup>1</sup>

TEST PERFORMED	STANDARD NON-QML <sup>2</sup>	/ES NON-QML <sup>2</sup>
Pre-cap Inspection Method 2017, 2032	yes	yes
Temperature Cycle (10 times) Method 1010, Cond. B, -55°C to +125°C, ambient	no	yes
Constant Acceleration Method 2001, 500 g	no	yes
Burn-in Method 1015 <sup>3</sup> 96 hours	no	yes
Final Electrical Test MIL-PRF-38534, Group A Subgroups 1 and 4: +25°C case	yes	yes
Hermeticity Test Fine Leak, Method 1014, Cond. A Gross Leak, Method 1014, Cond. C Gross Leak, Dip (1 x 10 <sup>-3</sup> )	no no yes	yes yes no
Final visual inspection Method 2009	yes	yes

Test methods are referenced to MIL-STD-883 as determined by MIL-PRF-38534.

Notes:

1. Refers to products that do not offer QML screening.
2. Standard and /ES, non-QML products, do not meet all of the requirements of MIL-PRF-38534.
3. Burn-in designed to bring the case temperature to the maximum case temperature of the product. Refer to the specific product information for the maximum case temperature.