

High Speed Switching Diodes

 Lead(Pb)-Free

Features:

- * High switching speed: max. 4 ns
- * Continuous reverse voltage: max. 75 V
- * Repetitive peak forward current: max. 500 mA

Applications:

- * High-speed switching in e.g. surface mounted circuits.

Description:

* The BAS516 is a high-speed switching diode fabricated in planar technology, and encapsulated in the SOD-523 (SC79) SMD plastic package.

SWITCHING DIODE
250 mAMPERES
75 VOLTS

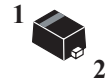

SOD-523

SOD-523 Outline Dimensions

Unit:mm

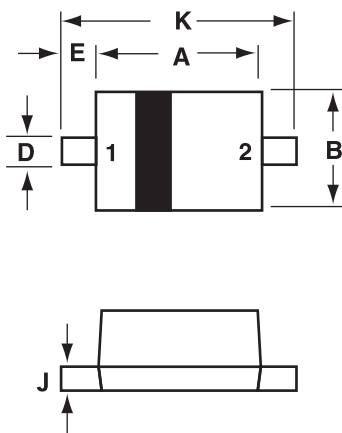

SOD-523		
Dim	Min	Max
A	1.10	1.30
B	0.70	0.90
C	0.50	0.70
D	0.25	0.35
E	0.15	0.25
J	0.07	0.20
K	1.50	1.70

PIN 1. CATHODE
2. ANODE

Maximum Ratings (T_A=25°C Unless otherwise noted)

Characteristic	Symbol	Value	Unit
DC Reverse Voltage	V _R	75	V
Mean Rectifying Current	I _O	250	mA
Peak Forward Surge Current @t=1s	I _{FSM}	500	mA
Operating Junction Temperature Range	T _J	+150	°C
Storage Temperature Range	T _{stg}	-65 to +150	°C

Electrical Characteristics (T_A=25°C Unless otherwise noted)

Characteristic	Symbol	Min	Typ	Max	Unit
Forward Voltage I _F =1mA	V _{F1}	-	-	0.715	V
I _F =10mA	V _{F2}	-	-	0.855	
I _F =50mA	V _{F3}	-	-	1.0	
I _F =150mA	V _{F4}	-	-	1.25	
Reverse Current V _R =25V	I _{R1}	-	-	0.03	μA
V _R =75V	I _{R2}	-	-	1.0	
Capacitance Between Terminals V _R =0, f=1MHz	C _T	-	-	1.0	pF
Reverse Recovery Time I _F = 10 mA , I _R = 10 mA, R _L = 100Ω Measured at I _R = 1mA; see Fig.6	T _{rr}	-	-	4.0	ns

Device Marking

Item	Marking	Equivalent Circuit Diagram
BAS516	6, 61	

Typical Characteristics

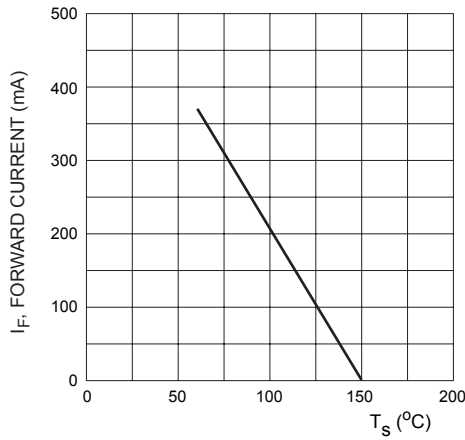

Fig.1 Maximum permissible continuous forward current as a function of soldering point temperature.

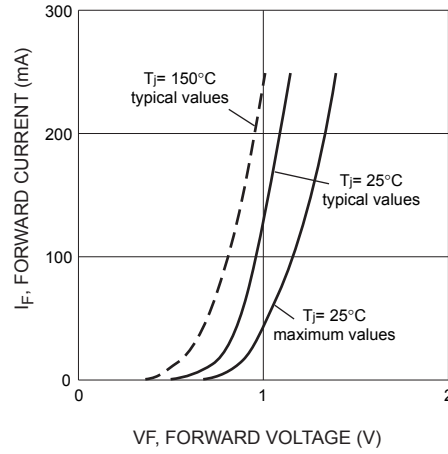

Fig.2 Forward current as Forward voltage

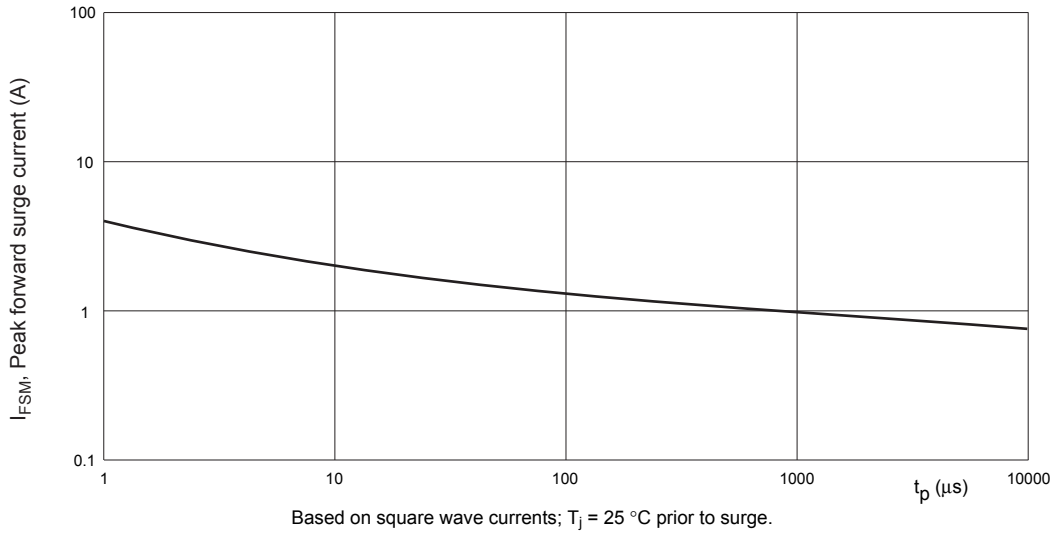

Fig.3 Maximum permissible non-repetitive peak forward current as a function of pulse duration.

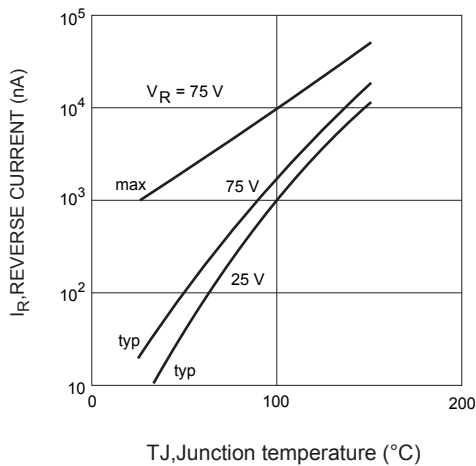

Fig.4 Reverse current as Junction temperature

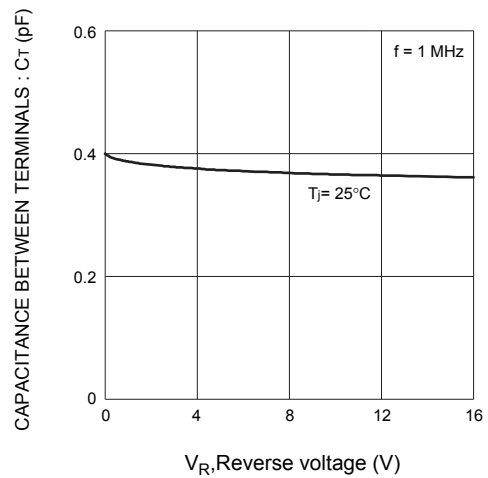
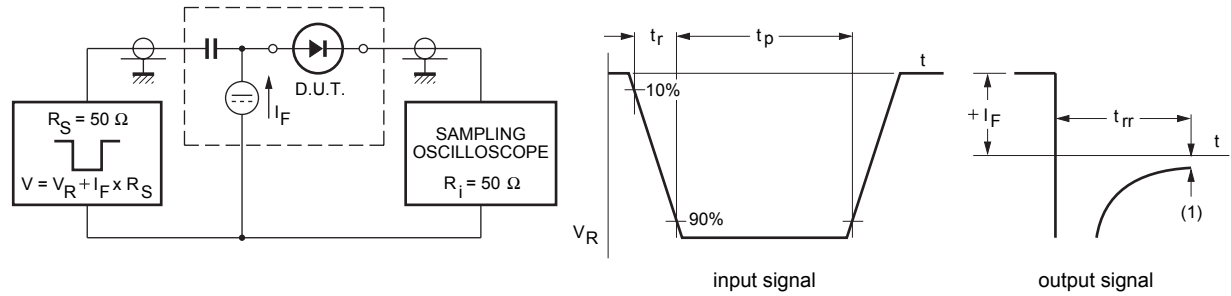

Fig.5 Capacitance between terminals characteristics

Typical Characteristics



(1) $I_R = 1 \text{ mA}$.

Input signal: reverse pulse rise time $t_r = 0.6 \text{ ns}$; reverse voltage pulse duration $t_p = 100 \text{ ns}$; duty factor $\delta = 0.05$;

Oscilloscope: rise time $t_r = 0.35 \text{ ns}$.

Fig. 6 Reverse recovery voltage test circuit and waveforms